

# Safety Begins With Us



**FR Clothing • Fall Protection & Engineered Systems  
Product Customization • Personal Protective Equipment  
Equipment Rentals • Certified Repairs & Recertifications**



Phone : 800.330.9240 • [www.gosafe.com](http://www.gosafe.com)

# The Medsafe Philosophy

*“Medsafe combines the technological and service capabilities of an international safety provider with the family feel that makes it comfortable to work with us on a long term basis. We listen to our customers to create progressive, custom e-commerce services along with flexible solutions to difficult safety situations.”*

*Burk Shaw, President*

Founded in 1979, Medsafe works out of five fully stocked service facilities in TX, AR, OK, and LA. We have grown into one of the most substantial privately held distributors of industrial safety, occupational health, industrial hygiene, and medical supplies in the United States.

Proud member of 



*30-Plus Years of Experience*



*Modern Inventory & Delivery System*



*Fall Protection Manufacturing*



*Web-Based Ordering*



*Inspection & Recert Center*



*Safety Supplies*



*First Aid Supplies*



*FR Clothing*



*Rental Program*



*Repair & Service Center*

## Medsafe : Core Services & Value Proposition

- Rental Equipment
- Web-based ordering and tracking
- Instrument Repair Services
- Custom Engineered Fall Protection Systems
- On Site Product Training Special Product Stocking programs.
- Self Contained Breathing Apparatus (SCBA) Maintenance & Inspection
- Gas Monitor Maintenance & Inspection
- Emergency Eyewash & Shower Station Maintenance & Inspection
- Self Retracting Lifeline (SRL) & Hoists Recertification
- Many, many additional services are available

The Medsafe inside and outside sales force is comprised of highly trained safety professionals. Our field specialists average over 20 years experience in supporting end user on site safety needs. Medsafe specializes in personal protective equipment, occupational health and safety and medical/first aid supplies. We have opted not to carry tools, ladders, gaskets, pipe, etc. for the simple reason that our business promise is to provide quick answers to difficult safety situations that protect your employees.

We understand the details needed to make personalized program and product recommendations, our veteran outside and inside safety sales specialists can provide immediate solutions to your problems. We consistently deliver on a timely basis and work with sites to proactively determine your needs. At Medsafe we are more than another distribution company; we are safety specialists and remain committed to being your total resource for PPE solutions.



Phone: (800) 330-9240 • Fax: (281) 476-5394 • E-mail: [sales@gosafe.com](mailto:sales@gosafe.com)





# Table of Contents

Proud member of 

Rental/Repair Programs.....	6
Product Customization .....	7
Fall Protection .....	24
Hand Protection .....	111
Clothing .....	138
FR Clothing .....	152
Eye Protection.....	172
Head/Face.....	195
Instrumentation.....	207
Communications .....	221
Respiratory .....	227
Hearing Protection.....	242
Footwear.....	251
Welding .....	265
Ergonomics .....	278
Hazmat .....	288
Facility .....	296
Seasonal PPE .....	311
Lockout/Tagout .....	343
Hi Visibility Safety .....	351
Signs .....	367
First Aid/Medical .....	435
Credit Application .....	551
Index .....	552



# Catalog Guide

<b>Rental/Repair Programs</b>	<b>6</b>	Supported .....	135
Rental/Repair Programs .....	6	Disposable .....	136
		Accessories .....	137
<b>Product Customization</b>	<b>7</b>	<b>Clothing</b>	<b>138</b>
Product Customization .....	7	Disposable Coveralls .....	140
		Aprons .....	143
		Sleeves .....	146
		Hair Nets .....	147
		Chaps .....	148
		Lower Leg Protection .....	148
		Rainwear .....	149
<b>Fall Protection</b>	<b>24</b>	<b>FR Clothing</b>	<b>152</b>
HLL Systems-Road & Bridge .....	32	Custom FR Garments .....	153
HLL Systems-Structural Steel .....	34	Flame Resistant Garments .....	154
HLL Systems-Concrete .....	36	Arc Flash Protection .....	166
HLL Systems-Specialty .....	38	Aluminized Clothing .....	168
HLL Systems-Universal Components .....	40	Rainwear .....	169
Full Body Harnesses (Reliance) .....	45	<b>Eye Protection</b>	<b>172</b>
Harness Care and Inspection .....	64	Safety Glasses .....	173
Full Body Harness Accessories .....	65	Bifocal Safety Glasses .....	184
Snaphooks & Carabiners .....	67	Dust & Particulate Eyewear .....	185
Positioning Devices .....	69	Goggles .....	187
Shock Absorbing Lanyards (Reliance) .....	70	Side Shields .....	190
Self Retracting Lifelines (Reliance) .....	79	Eyewear Accessories .....	191
Vertical Systems .....	83	Lens Cleaning Products .....	193
Anchorage Connectors .....	85	<b>Head/Face</b>	<b>195</b>
Confined Space and Rescue (Reliance) .....	93	Hard Hats .....	196
Standards .....	95	Faceshields .....	202
Guardrail Systems .....	96	Faceshield Brackets .....	202
Tool Lanyards (Reliance) .....	102	Accessories .....	206
Tool Lanyards (Ergodyne) .....	103	Logger's Combo .....	206
Tool Bags (Ergodyne) .....	105	<b>Instrumentation</b>	<b>207</b>
Tool Lanyards (Python) .....	106	4 Gas Monitors (BW) .....	208
Tool Bags (Python) .....	107	Single Gas Monitors (BW) .....	209
Perimeter Fencing .....	109	Docking Stations (BW) .....	210
Confined Space and Rescue (MSA) .....	110	Calibration Accessories (BW) .....	210
		Calibration Accessories (MSA) .....	211
		Docking Stations (MSA) .....	211
		4 Gas Monitors (MSA) .....	211
<b>Hand Protection</b>	<b>111</b>		
Cut-Resistant .....	112		
Impact .....	118		
Utility .....	121		
Palm Coated .....	122		
Driver .....	126		
Leather Palms .....	129		
Welding .....	131		
Canvas .....	133		
Jerseys .....	133		
String Knits .....	134		
Unsupported .....	135		



5 Gas Monitors (MSA) .....	211	Welding Helmets .....	266
6 Gas Monitors (RKI) .....	212	Powered Air Purifying Respirators .....	268
Stand Alone Transmitter (RKI) .....	213	Fume Respirators .....	271
Calibration Gases and Equipment .....	214	Clip On Welding Shields .....	271
Pump and Detector Devices .....	215	Welding Goggles .....	272
Air/Vapor Monitors.....	215	Welding Curtains .....	273
Weather Related Monitors .....	216	Faceshields .....	274
Light Meters .....	217	HEPA Welding Fume Extractors .....	275
Sound Level Meters/Noise Dosimeters .....	218	Swabs .....	275
<b>Communications</b> .....	<b>221</b>	Welding Gloves .....	276
Motorola Two-Way Radios .....	222	<b>Ergonomics</b> .....	<b>278</b>
Communication Headsets .....	226	Back Supports .....	279
<b>Respiratory</b> .....	<b>227</b>	Wrist Supports/Wraps .....	280
Disposable Respirators .....	228	Elbow Supports.....	283
Half Face Respirators and Cartridges.....	232	Knee Supports .....	285
Full Face Respirators and Cartridges .....	232	Ankle Supports.....	285
Half and Full Face Respirator .....	232	Knee Pads.....	286
Powered Air Purifying Respirators .....	235	<b>Hazmat</b> .....	<b>288</b>
Air Supply Hoses.....	236	Cabinets.....	289
Air Purification Accessories .....	236	Safety Cans.....	290
Blasting Helmets .....	237	Drums .....	291
Escape Respirators.....	239	Spill Control Pallets.....	291
SCBA's.....	239	Drum Accessories .....	291
Respirator Cleaning Products .....	240	Berms.....	293
Electronic Fit Testing.....	241	Sorbents .....	294
Respirator Storage.....	241	HazMat Spill Kits .....	294
Fit Test Kits and Accessories.....	241	Ventilation .....	295
<b>Hearing Protection</b> .....	<b>242</b>	Blowers .....	295
Earplugs.....	243	<b>Facility</b> .....	<b>296</b>
Earmuffs .....	247	Eye/Face Wash.....	297
Noise Dosimeters .....	250	Fire Extinguisher Accessories.....	298
<b>Footwear</b> .....	<b>251</b>	Fire Extinguishers .....	298
Leather Work Boots .....	252	Cigarette Receptacles .....	299
Rubber Boots .....	257	Protective Creams .....	299
PVC Boots.....	259	Hand and Surface Cleaners.....	300
Neoprene Boots.....	259	Headlamps .....	301
Waders .....	261	Flashlights.....	301
Hazmat Boots.....	261	Box Cutters .....	304
Overshoes.....	262	Tapes.....	304
Foot, Toe, Shin and Metatarsal Guards.....	264	Batteries.....	304
<b>Welding</b> .....	<b>265</b>	Domes and Mirrors.....	305
		Floor Mats.....	305
		In-Line GFCI .....	305

Forklift Safety .....	306	Safety Signs .....	369
Trailer Safety .....	308	Custom Signs.....	378
Tags/Labels.....	309	Labels.....	387
Storage Boxes/Cases.....	310	Safety Tags .....	389
<b>Seasonal PPE</b>	<b>311</b>	GHS Labels .....	393
Winter Liners.....	319	NFPA Placard Signs .....	395
Hard Hat Shades .....	330	Training Posters.....	396
Hard Hat Liners .....	331	Hazardous Waste Labels.....	398
Bandanas.....	332	Compliance Centers.....	400
Hydration Packs/Cool Vests .....	334	Metal Tags .....	403
Water Coolers .....	335	Pipe Markers .....	404
Activity Drinks/Powders .....	336	Lockout/Tagout.....	408
Sunscreens .....	339	Entry Permits .....	414
Insect Repellents .....	340	Traffic Signs .....	415
<b>Lockout/Tagout</b>	<b>343</b>	Floor Signs.....	418
Padlocks .....	344	Electronic Scoreboards.....	425
Lockout Hasps .....	345	Banners .....	428
Lockout Kits and Stations .....	345	Identification Badges .....	431
Lock Box /Hinge Box .....	348	Site-Boards™ .....	432
Cable Lockout .....	348	Store-Drawers™ .....	433
Breaker Lockout .....	349	Store-Boards™ .....	434
Power Cord/ Plug Lockout .....	349	<b>First Aid/Medical</b>	<b>435</b>
Electrical Switch Lockout.....	349	First Aid Kits.....	436
Valve Lockout.....	350	Burn Care.....	438
<b>Hi Visibility Safety</b>	<b>351</b>	First Aid Sprays and Creams .....	441
Class 2 Vests (Radians).....	353	Ointments .....	444
Class 3 Vests (Radians).....	356	Anti-fungal .....	447
Non-Rated Vests (Radians) .....	357	Analgesics .....	448
Hi-Vis Headwear.....	359	Industrial Medications.....	451
Vests (ML Kishigo) .....	359	Oral Medications .....	457
Traffic Cones .....	360	Mouth Care .....	461
Delineator Posts .....	361	Ear Care.....	462
Traffic Stanchions.....	361	Nasal Sprays.....	463
Tags.....	362	Eye Care .....	464
Barricade/Barrier Tape .....	362	IV's and IV Solutions.....	468
Traffic Signs .....	363	Syringes and Needles .....	469
Windsocks .....	364	Sharps Containers .....	473
Air Horn / Whistle .....	364	Trauma Kits.....	474
Wheel Chocks .....	365	EMS Supplies.....	475
Back-Up Alarms & Strobe Lights .....	366	Arm Slings .....	477
<b>Signs</b>	<b>367</b>	Splints .....	491
Safety Sign Information .....	368	Instruments and Trays .....	493
		Diagnostic Testing .....	499
		Testing Supplies .....	511
		Drug and Alcohol Testing .....	512
		Biohazard.....	515



Cleaners.....	517
Preps .....	519
Hand Cleansers .....	522
Skin Care .....	524
Dressings.....	525
Cohesive Bandages .....	530
Adhesive Bandages .....	533
Hot and Cold Packs .....	536
Exam Supplies.....	538
Personal Hygiene.....	543
Reference Books .....	544
Protective Wear .....	545
Gloves .....	546
Prescription Drug Authorization Form .....	550

<b>Credit Application</b>	<b>551</b>
---------------------------	------------

<b>Index</b>	<b>552</b>
--------------	------------



# Factory Authorized Repair Center

**Medsafe is a Factory Authorized Repair Center certified in the following fields:**

## Gas Detection

- ▲ Honeywell
- ▲ BW Technologies by Honeywell
- ▲ MSA
- ▲ RKI



## Hoist Repair

- ▲ Miller® Fall Protection
- ▲ MSA



## Retractable Repair

- ▲ Reliance
- ▲ Miller® Fall Protection
- ▲ MSA
- ▲ 3M



## Fire Extinguisher Inspection

- ▲ We perform annual inspections on all fire extinguishers. Please contact your Medsafe representative for more information.



# Rental Program

At Medsafe, our rental program specializes in a broad spectrum of equipment for customers with distinctive needs in the industrial workplace. Rentals are available on a daily, weekly or monthly basis depending on your need. If you have questions concerning our rental or repair program, please call or send an email to [service@gosafe.com](mailto:service@gosafe.com). Our goal is to provide you with quality products to meet all your application requirements.



## Rental Program Offers:

- ▲ Air Sampling Pumps
- ▲ Gas Detection Monitors
- ▲ Confined Space Kits
- ▲ Retractable Lifelines
- ▲ Ventilation Equipment
- ▲ Noise Dosimeters
- ▲ Quantitative Fittester
- ▲ CMS Analyzer



# Product Customization

Screen Printing • Embroidery • Pad Printing



*Safety Begins With Us...*

800.330.9240 • Order Online at [gosafe.com](http://gosafe.com)



# ***Product Customization***

## ***Custom Embroidery • Screen Printing***



**MEDSAFE**



# Customization

Screen Printing • Pad Printing







**MEDSAFE**

***Garment Customization Services***



# Embroidery

Embroidery is one of the first enhancements most customers look at when considering decoration of apparel. A logo announces to the world who you represent and a strong first impression can make a big difference in business. Imagine it can handle all aspects of your embroidery needs. We offer a wide selection of thread colors constructed of either 100% polyester (our default thread choice) or 100% rayon, which is available upon request through your Customer Service Representative or the embroidery department. Both selections ensure color vibrancy as well as colorfastness, though we do not recommend rayon thread for industrial laundered product. Read on to see some of the options available within the world of embroidery.

## How to Request a Custom Logo

- **Contact Customer Service** for additional information on submitting new logo image artwork.
- **Formats** - Acceptable formats for artwork of logo include: TIF, .BMP, .JPG, .EPS
- **Color / Thread Limitations** - Custom logos are limited to 9 colors.
- **Size** - A typical left or right chest location is about 2 1/2" x 3 1/2".  
Small detail in a logo design may require resizing or an adjustment so that detail can be seen. See following pages for size guidelines on garments and locations.
- **Digitizing Fees** - 1 to 8,000 stitches - **\$95.00\***. 8,001 stitches and up - **\$125.00\***
- **Color Changes** - There is a **\$25.00\*** fee for changing colors to an existing logo if a new logo number is required.
- **Revisions** - Charges for revisions are determined based upon complexity. There may be up to a **\$50.00\*** fee for customer requested revisions.
- **Time line** - Please allow up to 3 days to receive a sew-off of custom logos. Logos in excess of 20,000 stitches may require longer.

\* Prices subject to change without notice.



## Embroidery Guidelines and Success Tips

- Placement and size can differ based on the garment they will be sewn on. These pages show placements and size guidelines for various garment types.
- Embroidering on a garment with textures, prints or patterns can often make part of a logo difficult to see. Ask for a sew-off prior to placing orders to be certain that all words are legible and colors are visible.
- To determine the best size and placement for embroidery, photocopy the logo to the desired size, cut it out and place it on the garment in various locations until the best size and location is determined.
- If grommets, eyelets or badges will be going on the same side of a garment as embroidery, be sure to leave the appropriate space for the badge when specifying embroidery location.
- Embroidery requested on a pocket will render the pocket non-functional.



### EMBROIDERY CODES WITH SIZE GUIDELINES

All sizes below listed as inches.

<b>CMB</b> - Center Middle Back	10 x 10
<b>RSS</b> - Right Sleeve at Shoulder	4 x 4
<b>RUF</b> - Right Upper Front	4 x 4

▶ See page 15 for embroidery thread color options.



# Embroidery Locations



**SHIRT FRONT**



**SHIRT BACK**



**LEFT SIDE**



**RIGHT SIDE**



Medsafe uses colorfast embroidery threads for all embroidery applications. These threads are acceptable for Industrial and Homewash Processing. We are equipped to embroider garments, Oilfield bags, promotional items and a variety of other items. If you have questions, please do not hesitate to contact our customer service team at 800-330-9240.



# Emblem Embroidery

The same font selections and sizes shown on the previous page can also be applied to emblems. We offer a wide selection of emblem background and border combinations to complement whatever the garment color or pattern may be. Emblems are a great choice for striped or patterned shirts where direct embroideries can often blend in. Another benefit of selecting to embroider on emblems is the flexibility they provide for removal should an employee's position or name change.

Large Emblem

Font Size:  
5/8" 15 mm  
10 characters per line  
(Non-stock patch)



Small Emblem

Font Size:  
5/8" 15 mm  
7 characters per line  
(Stock patch)

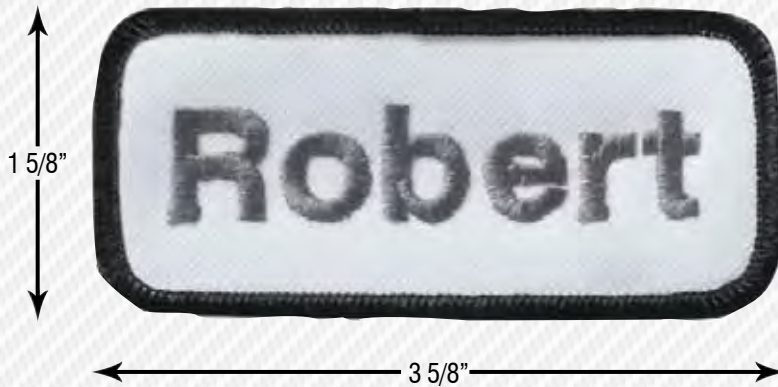

White, White Trim  
MSSBLANKWWH



White, Red Trim  
MSSBLANKWRD



White, Maroon Trim  
MSSBLANKWMR



White, Blue Trim  
MSSBLANKWRB



White, Navy Trim  
MSSBLANKWNB



White, Black Trim  
MSSBLANKWBL



# Stock Emblems

The possibilities are endless! Whether you choose from one of the emblems displayed here or supply us with your own emblems, our sewing operators can apply almost any shape emblem to your garments at time of order. There is no charge to store your emblems at our warehouse. Emblems are kept in a secured area and are applied at time of order, giving you the flexibility to decorate garments with different combinations and placements of emblems. We can also assist you with the development and procurement of new emblems. Lead time for custom emblems is 6 to 8 weeks

## All State Patches



**MSSTX** - Texas State Flag  
with Gold Trim 3 1/2" x 2"



**MSSLA** - Louisiana State Flag  
with Gold Trim 3 1/2" x 2"



**MSSOK** - Oklahoma State Flag  
with Gold Trim 3 1/2" x 2"



**MSSAR** - Arkansas State Flag  
with Gold Trim 3 1/2" x 2"



**MSSUS** - American Flag  
with Gold Trim 3 1/2" x 2"



# Direct Embroidery

Four fonts are offered for direct embroidery, with several sizes in each (3/8" - 1"). Embroider text directly on a garment, an emblem, or on a name strip. This option is most often used for names, titles, accredits, etc. and can be done easily without the need for digitization.

- Multiple lines of type, in the same or different sizes, can easily be added to a garment. To add more than one line, please contact a Customer Service Representative at 1.800.330.9240 to order this option.
- Please specify if all CAPS are required. Using all caps will reduce the number of characters per line. The characters listed below are based on lower case.

- Include spaces and punctuation when counting characters per line.
- Collar tip and cuff embroidery locations require 8mm font and are limited to 3 characters.

All fonts also available in 10mm (not shown).  
Call for more information.

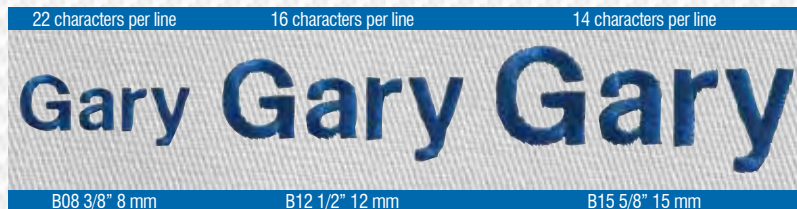

### BLOCK

**ABCDEFGHIJKLM  
NOPQRSTUVWXYZ  
abcdefghijklm  
nopqrstuvwxyz  
,.;:!"#\$%& 1234567890**

See thread colors  
page 15



# Trim Choices

## EMBROIDERY THREAD OPTIONS

### Classic Rayon 100% Viscose

Due to their superior quality and color fastness, Madeira rayon embroidery threads can be washed at 203°F with heavy duty detergents. (Use only those which contain no bleaching agents, peroxide, or optical brighteners as discoloration may result.)

While every attempt is made to reproduce thread colors accurately, colors on your monitor or print out may not precisely match actual thread colors.

1244		1025		1371		1320		1150	
1367		1172		1279		1235		1169	
1044		1171		1046		1111		1189	
1043		1066		1045		1031		1170	
1368		1061		1299		1319		1048	
1243		1067		1380		1388		1103	
1275		1135		1298		1188		1369	
1030		1083		1185		1310		1101	
1143		1124		1246		1309		1377	
1266		1125		1292		1321		1370	
1166		1065		1088		1109		1051	
1167		1137		1090		1110		1050	
1042		1024		1293		1383		1049	
1028		1069		1089		1187		1248	
1175		1068		1289		1234		1249	
1242		1064		1291		1121		1251	
1076		1223		1091		1120		1250	
1075		1180		1094		1108		1079	
1074		1267		1093		1354		1302	
1133		1222		1095		1186		1301	
1134		1022		1295		1184		1247	
1029		1023		1294		1154		1280	
1177		1323		1092		1148		1073	
1176		1196		1373		1181		1097	
1274		1224		1096		1147		1282	
1276		1359		1296		1037		1245	
1277		1192		1297		1146		1284	

# EMBROIDERY THREAD COLORS

1018		1311		1281		1393		1070	
1254		1080		1384		1306		1270	
1221		1033		1385		1339		1372	
1053		1334		1182		1337		1173	
1217		1122		1381		1308		1257	
1226		1032		1081		1394		1272	
1021		1232		1107		1390		1256	
1253		1312		1014		1391		1056	
1026		1313		1114		1227		1258	
1155		1233		1015		1219		1158	
1278		1263		1016		1195		1057	
1078		1387		1307		1304		1126	
1178		1362		1238		1397		1149	
1378		1264		1376		1351		1138	
1379		1363		1375		1098		1128	
1152		1365		1132		1047		1329	
1017		1364		1027		1100		1129	
1013		1153		1160		1396		1230	
1113		1360		1162		1303		1144	
1019		1353		1290		1395		1084	
1020		1236		1052		1392		1055	
1179		1382		1252		1099		1255	
1038		1141		1161		1104		1344	
1077		1356		1163		1102		1338	
1317		1386		1349		1106		1273	
1220		1035		1159		1156		1348	
1039		1119		1352		1357		1374	
1366		1034		1191		1140		1174	
1335		1389		1347		1340		1341	
1261		1183		1260		1350		1218	
1330		1117		1123		1193		1054	
1343		1116		1305		1190		1358	
1322		1115		1105		1194		1036	
1112		1315		1157		1225		1142	







# Reflective Striping

Enhanced visibility can be critical when working in high-traffic areas, on construction sites or around equipment operation. Adding reflective striping to your uniform can make a lifesaving difference. Select from the many trim widths, colors and placements to make your enhancements have the highest impact. These distinctive stripings can be added to most garments. Flame-resistant striping is also available. The garments and striping you select should depend on the end use requirements.

The following front and back images on page 21 indicate all single reflective stripe locations for most products. With a few exceptions, stripes shown above the waist can be applied to a shirt, jacket or coverall. Stripes shown below the waist can apply to a pant, short, or coverall. The specific details of a garment, like the size of a pocket, the placement of closures, an emblem or an additional pocket, may dictate a slight change in the placement from what is shown in these images.

- Striping applied post-manufacturing will always go around a pocket or emblem. Pockets cannot be removed for reflective trim application.
- Stripes on a waistband will be moved up or down if the waistband has elastic sections.





## Reflective Striping Locations

Stripe Codes	Location Description	Front	Back
<b>BSB</b>	Both Sleeves Bicep	•	•
<b>BSF</b>	Both Sleeves Forearms	•	•
<b>BLC</b>	Both Legs Calf	•	•
<b>FXB</b>	Full X Back		•
<b>DVB</b>	Double Vertical Back		•
<b>DHB</b>	Double Horizontal Back		•



S1 / EH5215 1"

S2 / EH5216 2"

Y3 / EH5207 2"

1Q / EH5227 2½"





www.gosafe.com  
Safety Begins With Us.



***Pad Printing Services***



## PRICING • Eyewear Pad Printing



### Imprinting

- ▲ Minimum order quantity of 24.
- ▲ Imprinting available on the temple or lens, depending on the style.
- ▲ One (1) and two (2) colors available.
- ▲ Camera ready artwork required.
- ▲ Not available for all styles. Please contact a Medsafe sales representative for additional details.

Item #	Glass Quantities	1 Color	2 Color
MSSELCOL-24	24-47	\$3.20	\$6.40
MSSELCOL-48	48-95	\$1.99	\$3.98
MSSELCOL-96	96-155	\$1.38	\$2.76
MSSELCOL-156	156-287	\$1.14	\$2.28
MSSELCOL-288	288-503	\$0.97	\$1.98
MSSELCOL-504	504-UP	\$0.89	\$1.78
Item #	# Colors	Setup Fee	
MSSPADSETUP	1 Color	\$20.00	

## PRICING • Hard Hats Pad Printing



### Imprinting

- ▲ Minimum order quantity of 20.
- ▲ Imprinting available on the front, back, or sides.
- ▲ Up to 4 colors available in 4 hat locations.
- ▲ Camera ready artwork required.
- ▲ Not available for all styles. Please contact a Medsafe sales representative for additional details.

Item #	Quantities	Position 1 Up To 4 Colors	Position 2 Up To 4 Colors	Position 3 Up To 4 Colors	Position 4 Up To 4 Colors
MSALOGOMIN20	20	\$5.01	\$10.02	\$15.03	\$20.01
MSALOGOMIN40	40	\$3.34	\$6.68	\$10.02	\$13.36
MSALOGOMIN60	60	\$2.85	\$5.70	\$8.55	\$11.40
MSALOGOMIN80	80	\$2.37	\$4.74	\$7.11	\$9.48
MSALOGOMIN100	100	\$1.40	\$2.60	\$3.90	\$5.20
Item #	# Colors	Setup Fee			
MSALOGO1	1 Color	\$100.00			
MSALOGO2	2 Color	\$125.00			
MSALOGO3	3 Color	\$150.00			
MSALOGO4	4 Color	\$175.00			

A digital proof will be provided so that the customer can sign off and approve the artwork before orders are processed and started.

### CAMERA READY ARTWORK

Camera ready artwork must be supplied. If the artwork has to be recreated additional charges apply. The definition of camera ready artwork is black art on white background. The images/letters must be clear and must be the exact representation of the desired logo. For multi-color logos, artwork must have individual color separations with registration marks. Photocopies, business cards, decals, faxes, etc. are not considered Camera Ready.

**\*\* For vests, a 300 dpi JPG closer to the final imprinting size is preferable\*\*.**

*Medsafe may have resources for other product personalization that you might need. Please contact your Medsafe representative for more information.*





**MEDSAFE**

***Screen Printing Services***



## PRICING • Silk Screen



Medsafe has the capability to silk screen a variety of products such as safety vests, rainwear, T-shirts and promotional items.

- ▲ Minimum order quantity of 24.
- ▲ Screening available on the back and front (some styles).
- ▲ Up to four (4) colors available.
- ▲ Camera ready artwork required.
- ▲ Not available for all styles. Please contact a Medsafe sales representative for additional details.

Note: The Logo Department will make final determination on number of logo colors after receiving vector art files. Must receive ai or eps vector logo files, or an additional \$50 logo set-up fee may apply, which may also delay the order. Must also receive PMS colors if exact color match is required, \$35 fee. Otherwise colors will be matched as close as possible. A digital proof will be provided so that the customer can sign off and approve the artwork before orders are processed and started.

### CAMERA READY ARTWORK

Camera ready artwork must be supplied. If the artwork has to be recreated additional charges apply. The definition of camera ready artwork is black art on white background. The images/letters must be clear and must be the exact representation of the desired logo. For multi-color logos, artwork must have individual color separations with registration marks. Photocopies, business cards, decals, faxes, etc. are not considered Camera Ready.

**\*\* For vests, a 300 dpi JPG closer to the final imprinting size is preferable\*\*.**

Item #	# Colors	Setup Fee
MSSLCSETUP1	1 Color	\$25.00
MSSLCSETUP2	2 Color	\$50.00
MSSLCSETUP3	3 Color	\$75.00
MSSLCSETUP4	4 Color	\$100.00
MSSLCSETUP5	5 Color	\$125.00

Item #	Desc.	Setup Fee
EPRSETUP	Artwork Fee/PMS Color Code Match	\$90.00

*Fee may be waived if approved artwork is provided by customer.*

Item #	Quantities	Cost For 1-Color Logo	Cost Per Additional Color Up To 7 Colors
MSSLCOL-24	24-71	\$1.85	\$1.33
MSSLCOL-72	72-119	\$1.40	\$1.13
MSSLCOL-144	120-287	\$1.33	\$0.80
MSSLCOL-288	288-50	\$0.90	\$0.67
MSSLCOL-504	504 and Up	\$0.75	\$0.53

*Medsafe may have resources for other product personalization that you need. Please contact your Medsafe representative for more information.*

## PRICING • Direct Embroidery

Four fonts are offered for direct embroidery, with several sizes in each (3/8" - 1"). Embroider text directly on a garment, an emblem, or on a name strip. This option is most often used for names, titles, accredits, etc. and can be done easily without the need for digitization.



Item #	Description	Pricing
MSSEMBRDIR	Direct Name Embroidery on Front Chest	\$6.00
MSSEMBRO	Company Name/Title Direct Embroidery on Front Chest	\$6.00
MSSEMBDFC	Company Logo Direct Embroidery Front Chest (1-8,000)	\$8.50
MSSEMBDBK1	Company Logo Direct Embroidery Bk (1-12,000 stitches)	\$12.50
MSSEMBDBK2	Company Logo Direct Embroidery Front or Back (12,001 + stitches)	Call for Pricing



# Fall Protection





Reliance Fall Protection began operations in the year 2000 by patenting a revolutionary new technology for the design of horizontal lifeline systems that allowed the reduction of fall height requirements without increased end-loadings. These TunedCable™ horizontal lifelines are one of those “it can’t be done” innovations that suddenly appear simple once the science behind them is understood. The lifelines were followed by unique anchorages, the concrete embed system with remote connection, beam clamps and trolleys, and other engineered products.

Reliance has now turned attention to harnesses and lanyards, with the patent pending “TattleTale®” webbing, the “FatPack™” two-in-one shock absorbing lanyard, and especially the Steelhead® tieback hook. The SteelHead® is another “it can’t be done” product, a standard-layout true double-action locking snap hook that makes it possible for workers to safely tie

back into their own lanyards. And with these additions Reliance has assembled a complete range of cutting-edge fall protection products that represent the very Highest Standards in Personal Fall Protection Equipment.

Reliance Fall Protection is quickly becoming the go-to organization for custom and unique industry solutions. With a full in house engineering staff, product development department, testing facility and vertically integrated manufacturing process, difficult fall protection solutions can go from concept to application in a single streamlined process.

For more information about Reliance Fall Protection products, visit us at [www.relsafe.com](http://www.relsafe.com) or call us at 1-800-330-9240.

*\*PLEASE NOTE : Items purchased may vary in appearance from those pictured in this catalog. Reliance reserves the right to change product descriptions and specifications without notice.*



**“Dedicated to Raising the Standards  
In Personal Fall Protection Equipment”**





Reliance Fall Protection is proud to offer premier fabrication and production facilities in both Wheat Ridge, Colorado and Deer Park, Texas. Incorporating the latest technology for our industry allows Reliance to maintain our commitment to "Higher Standards." Lifeline production facilities utilize, mig welding processes, industrial CNC controlled milling machines, plate shearing and breaking, as well as plasma cutting and water jet processes. Within our textile processing plant, CNC controlled sewing machines, CNC cutting and marking machines, as well as automated grommet machines assist in the quality and dependability of our products. Reliance is dedicated to providing higher standards through

our engineering department as well as research and development. Autocad™, SolidWorks™, and Autodesk Inventor™ are just a few of the software programs incorporated into the engineering and design process. The Reliance Industries manufacturing team offers over 50 years of experience in the fall protection industry. Our team is committed to offering the safest work environment possible. For the "at risk" worker as well as within our own family, engineering a safe workplace is our responsibility and future.







The Reliance Testing Laboratory is a division of Reliance Fall Protection, is ISO 17025 accredited and is utilized to perform Qualification and Verification Testing as required by ANSI Z359.7-2011. The Lab features ANSI compliant, certified test towers as well as all of the certified equipment required to perform dynamic and static tests necessary to demonstrate compliance with the applicable ANSI standards for fall protection.

Reliance Testing Laboratory operates equipment that can perform tensile testing up to 20,000 lbs (88.8kN), and drop towers that capture data via DasyLab™ software which translates the information to spreadsheets and graphs. Through the analysis produced, Reliance is able to uncover opportunities to improve product performance and service life.

With state of the art equipment and processes, Reliance is able to provide users with test results from real tests verifying your equipment's performance and conformity. Whether we are verifying quality and conformity on our current selection of products or developing and qualifying new solutions, Reliance truly raises the bar by testing products to meet existing the standards and then going a step further to ensure they meet our requirements for a higher standard in fall protection.

## Training

Training your employees in fall protection is a great way to increase awareness about the hazards of falling from heights. At Reliance, we offer several training courses that help users identify hazards, understand the risks, develop inspection procedures and programs, and implement procedures to mitigate the hazards associated with fall protection. Knowledge is truly the key to providing a safe work place for your employees. Reliance offers a monthly training program for Competent Inspectors of Fall Protection Equipment, as well as quarterly courses for Fall Protection Competent Persons.

## Training Classes Available

### Competent Inspector (Monthly)

The Competent Inspector's course builds upon a student's practical knowledge of fall protection through the discussions of in-house testing and literature review; UV and chemical exposure to synthetic strapping and is designed to increase personal skill level through a variety of hands-on inspection exercises.

### Competent Person (Quarterly)

The Competent Person training is an intensive program that develops a strong overall knowledge of how to use, select and install conventional and non-conventional fall protection equipment. In class lectures including slides and video, hands on scenarios applying practical workplace situations.

*For more information on Fall Protection Training from Reliance, please see page 98.*





Working at heights is inherently dangerous. While it is impossible to eliminate every risk, Reliance fall protection equipment has been designed to substantially reduce the risk of injury. Most fall related injuries are the result of faulty or abused equipment, lack of training, failure to follow the manufacturer's instructions, or simple failure to use good judgment. No manufacturer can accept the liability for damages that result from equipment that has been improperly used or abused - that remains the responsibility of the user.

Choosing fall protection equipment that effectively protects workers from hazards while remaining in compliance with government regulations can be an intimidating task. OSHA 1926.501(b)(1) states: "Each employee on a walking/working surface (horizontal and vertical surface) with an unprotected side or edge which is 6 feet (1.8M) or more above a lower level shall be protected from falling by the use of guardrail systems, safety net systems, or personal fall arrest systems".

The regulations cover many specific instances pertaining to fall hazards. In each case, the Personal Fall Arrest System is mentioned as a form of protection. When assembling a Personal Fall Arrest System, or "PFAS", it is imperative to know and remember the components necessary to complete a system. Those components are:

### **A = Anchorage Device B = Body Harness C = Connecting Device D = Deceleration Device**

*\*PLEASE NOTE: The regulations quoted here represent only a fraction of the regulations in place which govern fall protection. They are meant to serve as a general guideline, and there may be more specific or more stringent regulations in effect beyond those quoted here that apply to your specific application.*

**ANCHORAGE** means a secure point of attachment for lifelines, lanyards or deceleration devices. "Anchorages used for attachment of personal fall arrest equipment shall be independent of any anchorage being used to support or suspend platforms and capable of supporting at least 5,000 lbs. (22 kN) per employee attached, or shall be designed, installed, and used as follows:

[OSHA 1926.502(d)(15)(i)] : As part of a complete personal fall arrest system which maintains a safety factor of at least two; and [OSHA 1926.502(d)(15)(ii)] : Under the supervision of a qualified person.

When choosing an anchorage point, be certain it is appropriate for the system being attached - Personal Fall Arrest Systems utilizing a standard shock absorbing lanyard as a deceleration device must be capable of supporting a 310 lb. person after free falling for 6 feet (5,000 lb. requirement). PFAS's utilizing a self retracting lifeline must be capable of supporting twice the potential impact energy generated by a 310 lb. person who has fallen (3,600 lb. requirement).

**CONNECTOR** means a device which is used to couple (connect) parts of the personal fall arrest system and positioning device systems together. It may be an independent component of the system, such as a carabiner, or it may be an integral component of part of the system (such as a buckle or D-ring sewn into a body belt or body harness, or a snap-hook spliced or sewn to a lanyard or self-retracting lanyard). "Connectors shall be drop forged, pressed, or formed steel, or made of equivalent materials" [OSHA 1926.502(e)(3)]. "Connecting assemblies shall have a minimum tensile strength of 5,000 lbs. (22 kN)." [OSHA 1926.502(e)(5)].

Connectors come in a wide variety of shapes and sizes, and; as stated above, may be an independent part of the PFAS, or an integral part of one of the PFAS components. Connectors should be selected with respect to their potential attachment point-i.e. : will the connectors allow the components to fit together properly, and is there a potential for accidental disconnection. NEVER CONNECT TWO SNAPHOOKS TO ONE ANOTHER, HOOK-TO-HOOK. Independent connectors used as attachments to anchorage points or anchorage devices should be considered along the same guidelines. The most important aspect of connectors is inspection before use. Damaged, abused, or worn out connectors will render the PFAS component useless, and it must be immediately withdrawn from service.

**BODY HARNESS** means straps which may be secured about the employee in a manner that will distribute the fall arrest forces over at least the thighs, pelvis, waist, chest and shoulders with means for attaching it to other components of a personal fall arrest system.

*"Personal fall arrest systems, when stopping a fall, shall limit maximum arresting force on an employee to 1,800 lbs. when used with a body harness" [OSHA 1926.502(d)(16)(2)].*

Full Body Harnesses are designed to protect a worker from falling while limiting the extent of potential injury resulting from a fall. To accomplish this task the harness should be adjusted to fit the wearer properly. A harness should be snug but comfortable, and should not bind the wearer. The sub-pelvic strap should be positioned under the buttocks. This is crucial, as it is the sub pelvic strap that dissipates much of the energy generated in a fall. All connectors must be fastened properly, the chest strap fastened securely, and the dorsal D-ring should rest between the wearer's shoulder blades.

**DECELERATION DEVICE** means any mechanism, such as a rope grab, rip-stitch lanyard, specially-woven lanyard, tearing or deforming lanyards, automatic self-retracting lifelines/lanyards, etc., which serves to dissipate a substantial amount of energy during a fall arrest, or otherwise limit the energy imposed on an employee during fall arrest. "Personal fall arrest systems, when stopping fall, shall: limit maximum arresting force on an employee to 1,800 lbs. (8 kN) when used with a body harness; be rigged such that an employee can neither free-fall more than 6 feet (1.8 m), nor contact any lower level." [OSHA 1926.502(d)(16)(iii),(iv),(v)]

Choice of a deceleration device should be determined by the amount of clear free fall space below the user. All users of fall protection equipment should be competently trained in how the equipment works and how to calculate free-fall, deceleration, elongation, total fall distance, and total clearance distance. Self retracting lifelines are recommended when there is a limited fall distance to the next level or the ground. Regardless of device, it is important that the anchorage point be located as close to directly above the user's head as possible. Travel more than 15° in any direction from the anchorage point increases the possibility of a "pendulum" effect wherein the user falls, and the arc of travel after complete arrest allows contact with the lower level.





### Computing Free-Fall Distance with a Shock Absorbing Lanyard

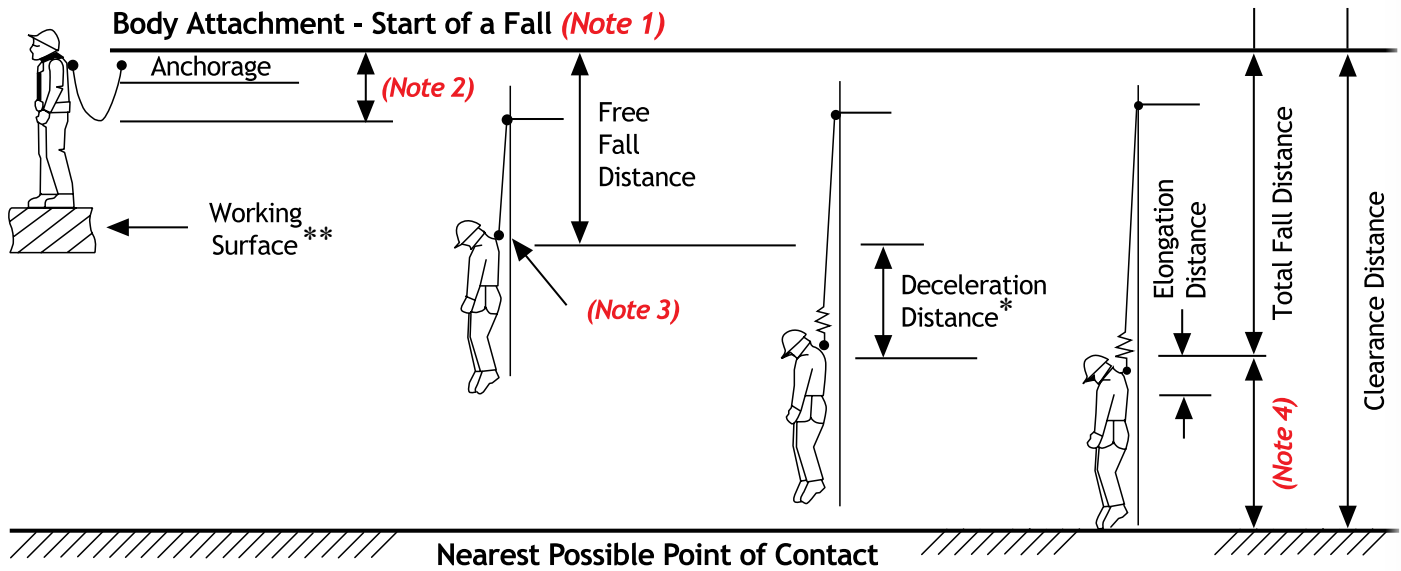

#### Note 1

The anchorage should be above the body attachment point; however, this may not always be possible (i.e. when no structure exists overhead).

#### Note 2

The lanyard slack and distance between the body and anchorage attachments shall be included in the fall arrest system design for each specific use.

#### Note 3

The movement of the harness attachment from rest to load shall be included in the free fall distance.

#### Note 4

The elongation distance plus the distance from the body attachment to the body impact area shall be included in the fall arrest system design for each specific use.

### Computing Free-Fall Distance with a Self Retracting Lifeline

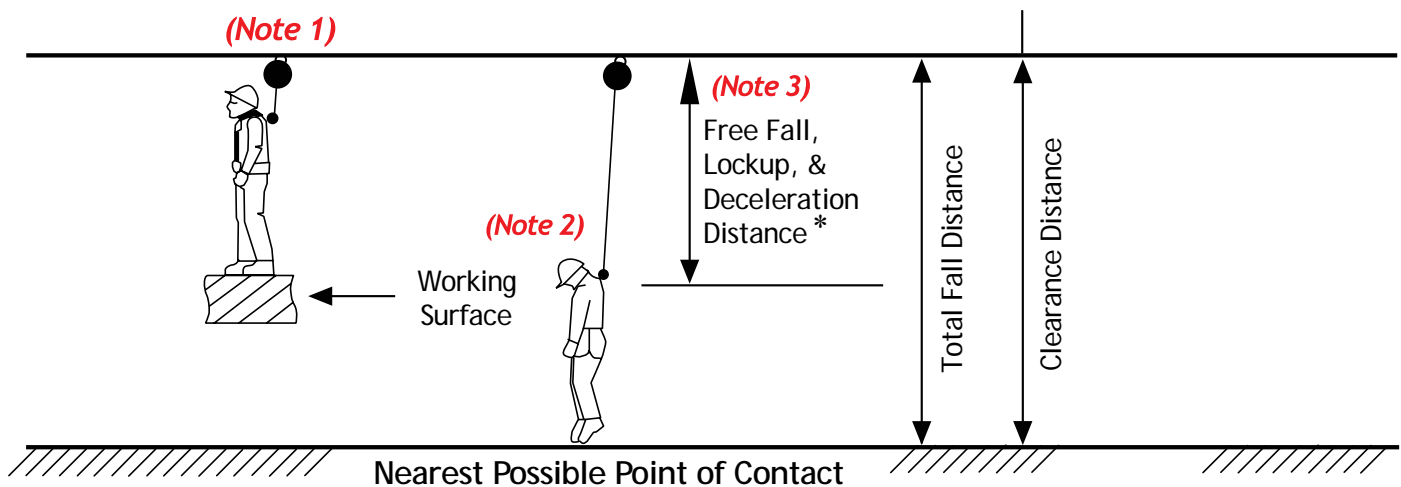

#### Note 1

The anchorage should always be above the body attachment point at no more than 15° from vertical.

#### Note 2

The movement of the harness attachment from rest to load shall be included in the total fall distance.

#### Note 3

The deceleration distance plus the distance from the body attachment to the body impact area shall be included in the fall arrest system design for each specific use.

\* Instruction manuals for each product contain detailed information regarding deceleration distances for those specific products

\*\* Consideration must also be given to the distance below the walking/working surface





All Skyline<sup>®</sup> horizontal lifeline systems use Tuned Cable<sup>®</sup> technology. Cable tuning (or the use of high pre-tensioned cables) has been shown to significantly reduce fall arrest distances and line tensions during fall arrest. This is accomplished by the fact that a scientifically tuned HLL cable reduces the input momentum of a falling weight and at the same time forces the cable to absorb the energy generated during a fall at a higher rate. This allows the design of systems with longer line lengths and lower final line tensions than previously thought possible. This creates the need for fewer bypass supports to reduce line tension, thus lower overall system cost.

### Tuned Cable<sup>®</sup> technology permits:

- Free spans up to 200' (61m) without intermediate supports
- Lower end loads, which means easier installations in more and different locations
- Multiple end-anchor choices for every situation: rebar clamps, concrete beam straps, anchors, concrete inserts, weld-on lugs, bolt-on clamps, I-Beam clamps and more.
- Available with a choice of stanchions to raise the lifeline above the walkway or with in-line clamps where overhead structure exists.
- All systems are available with bypass supports to reduce line tension and limit fall distances.

Reliance systems are engineered, so you're assured they will comply with all applicable OSHA and ANSI requirements and standards. They're supplied with complete documentation so they will meet the requirements for anchorage performance, design and component traceability for OSHA inspections. And at a reasonable price.

**Skyline<sup>™</sup> Horizontal Lifeline Shock Absorber**

The key to the "Tuned" Horizontal Lifeline System is the Skyline<sup>™</sup> high pre-tension shock absorber. It features all stainless steel construction and has a built-in tension indicator to verify the horizontal lifeline is at the proper line tension.

- Overall dimensions : 12.5" L X 2.5" W X 2" H (31.75 X 6.35 X 5cm)
- Weight : 2 lb. (.9Kg)
- Construction : All stainless steel construction
- Activation Force : 2,000 lb. (8.8kN)
- Elongation: 5-1/4" (13.3cm)
- Ultimate Strength : 14,500 lb. (64kN)
- Initial Line Tension : 1,000 lb. (4.4kN)

*Notes: Skyline Shock Absorbers are not re-usable after deployment.*

US Patent # 6,338,399

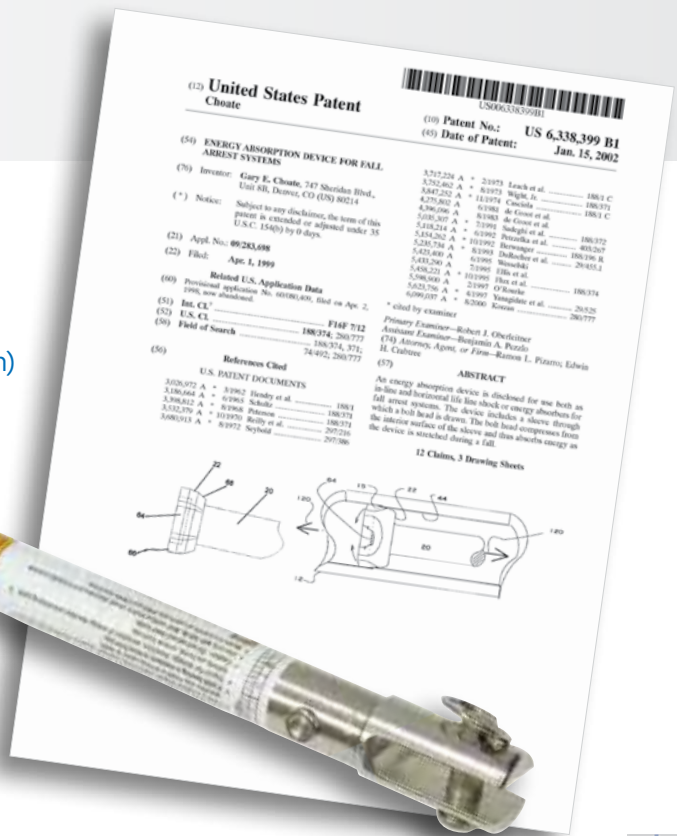



Reliance has developed a computer program to aid in quickly determining the viability of a horizontal lifeline installation. This program provides traceability to actual test results obtained in extensive testing on single and multi span systems (systems up to 200' (61m) in length which support up to 4 users). The Reliance "Horizontal Lifeline Wizard™" program is accessible to registered users of our website, located at [www.relsafe.com](http://www.relsafe.com).

Anticipated lifeline tension and minimum required clearance beneath the walking surface are determined instantly by entering the following five items :

- Number of system users required
- Total lifeline length
- Number of intermediate supports
- Elevation of the lifeline above the walking surface
- The type of deceleration device used

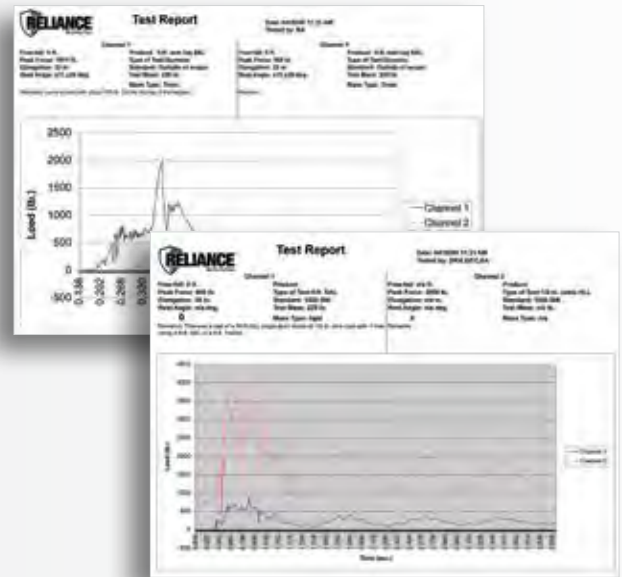

Horizontal Lifeline Wizard end loading and deflection data is based on empirical test results like those shown above



The Horizontal Lifeline Wizard™ steps through creation of a viable horizontal lifeline system.

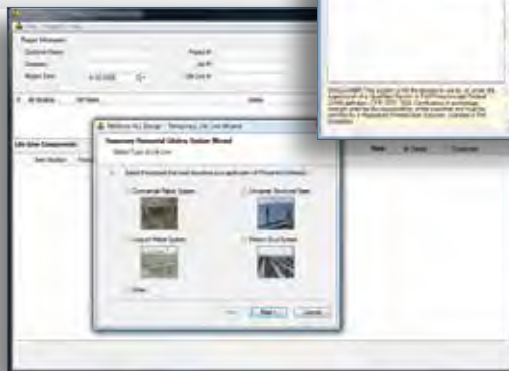
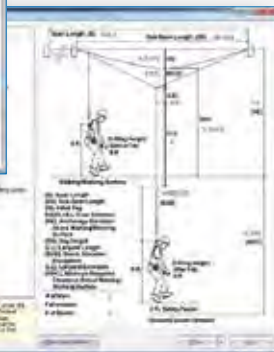
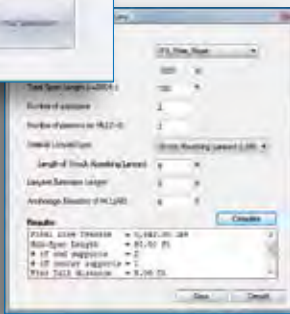

Item No.	Item Name	Quantity	Unit	Description
0001	1/2" Dia. Steel Cable (304 Stainless)	1	ft	100'
0002	3/4" Dia. Steel Cable (304 Stainless)	1	ft	100'
0003	1/2" Dia. Steel Cable (304 Stainless)	1	ft	100'
0004	1/2" Dia. Steel Cable (304 Stainless)	1	ft	100'
0005	1/2" Dia. Steel Cable (304 Stainless)	1	ft	100'
0006	1/2" Dia. Steel Cable (304 Stainless)	1	ft	100'
0007	1/2" Dia. Steel Cable (304 Stainless)	1	ft	100'
0008	1/2" Dia. Steel Cable (304 Stainless)	1	ft	100'
0009	1/2" Dia. Steel Cable (304 Stainless)	1	ft	100'
0010	1/2" Dia. Steel Cable (304 Stainless)	1	ft	100'

## "Intuitive Horizontal Lifeline design"

Since the calculations are almost instant, many design combinations may be viewed to obtain the best design for protection of the affected worker(s). The program will automatically invalidate the system if it is not viable based on the entries. When a viable system is configured, the user can generate a bill of material based on the components required for the system designed.

The Horizontal Lifeline Wizard™ also gives users the ability to :

- Adjust variables for changing workplace geometry
- Automatically generate design documents for traceability and identification
- Preview performance data
- Create site specific designs
- Analyze comparable designs
- Invalidates system configurations that do not maintain the 2:1 Safety Factor required by OSHA.





Reliance offers a variety of engineered horizontal lifeline systems that are specifically designed to address the fall protection hazards associated with the construction and maintenance of roadways and bridges. These systems use components that were developed to meet the standard requirements of road and bridge work environments, and have been thoroughly field tested on actual jobsites.

Reliance Horizontal Lifeline Systems for Road and Bridge work share a common horizontal lifeline system, but use different anchor, stanchion, and other elements specific to the environment in which they are installed. On the opposite page is a breakdown of the lifeline cable component common to each system, along with a listing of individual components specific to the systems listed in this section. Components are called out numerically on the system illustrations.

## Looped Rebar System

Stanchions attach to rebar loops in concrete bridge beams. Loop dimensions are 2-1/2" min ID and 9" (6.3/22.8 cm) max height. Use #4 rebar, minimum half inch, grade 40 or 60. Stanchions are the same as those used in the Universal System and are available in 5, 6 or 7' (1.5, 1.8, 2.1 m) heights. The looped rebar system uses the 6310 Portable horizontal lifeline. These systems require tiebacks made of 2" 18,000 lb. (5cm/80kN) sling webbing with ratchet tensioners. Stanchions can pivot 7 degrees left or right to allow clearance for decking panels.

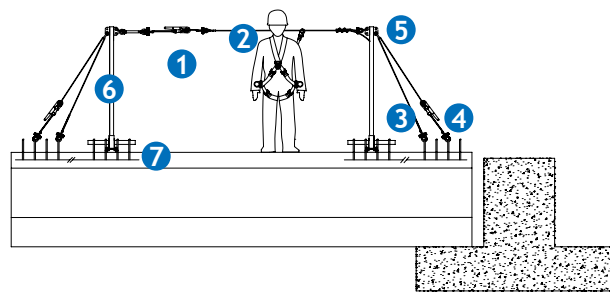

- 6310 Horizontal Lifeline Kit
- 6070-XXX 3/8" (10mm) 7x19 galvanized cable-specify length (6072=stainless cable)
- 6120 X 2 2" X 15' (50mm X 4.5m) tieback strap
- 6122 X 2 Tieback Ratchet Assembly
- 6066 X 6 Stainless Bow shackles

- At least two of each of the following :
- 6151 60" (1.5m) Combo End/Bypass Stanchion\*
  - 6170 Looped Rebar Base Stanchion Receiver Bracket

\*Additional bases and stanchions may be used for intermediate supports if necessary

## Nelson Stud System

Receiver and tie-back brackets are designed to clamp directly to Nelson Studs. Brackets are designed to allow enough space on beams to allow decking panels to be flown in to place without interference from brackets.

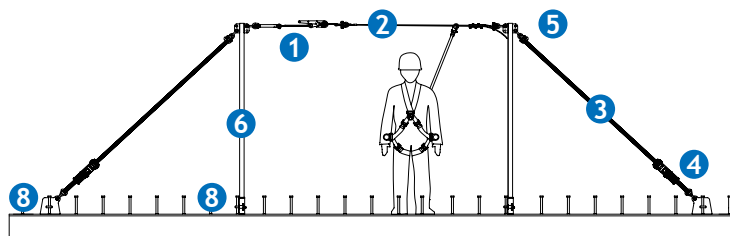

- 6310 Horizontal Lifeline Kit
- 6070-XXX 3/8" (10mm) 7x19 galvanized cable - specify length (6072=stainless cable)
- 6127 X 2 2" X 15' (50mm X 4.5m) tieback strap
- 6122 X 2 Tieback Ratchet Assembly
- 6066 X 6 Stainless Bow shackles

- At least two of each of the following :
- 6151 60" (1.5m) Combo End/Bypass Stanchion\*

- At least two of each of the following (4 per system):
- 6260 Nelson Stud Base
  - Standard of 7-3/8" to 7-5/8" (18 to 18.3cm) stud length. Other sizes available - contact Reliance for more information

\*Additional bases and stanchions may be used for intermediate supports if necessary

## Road & Bridge Systems : System Components



### Additional Components

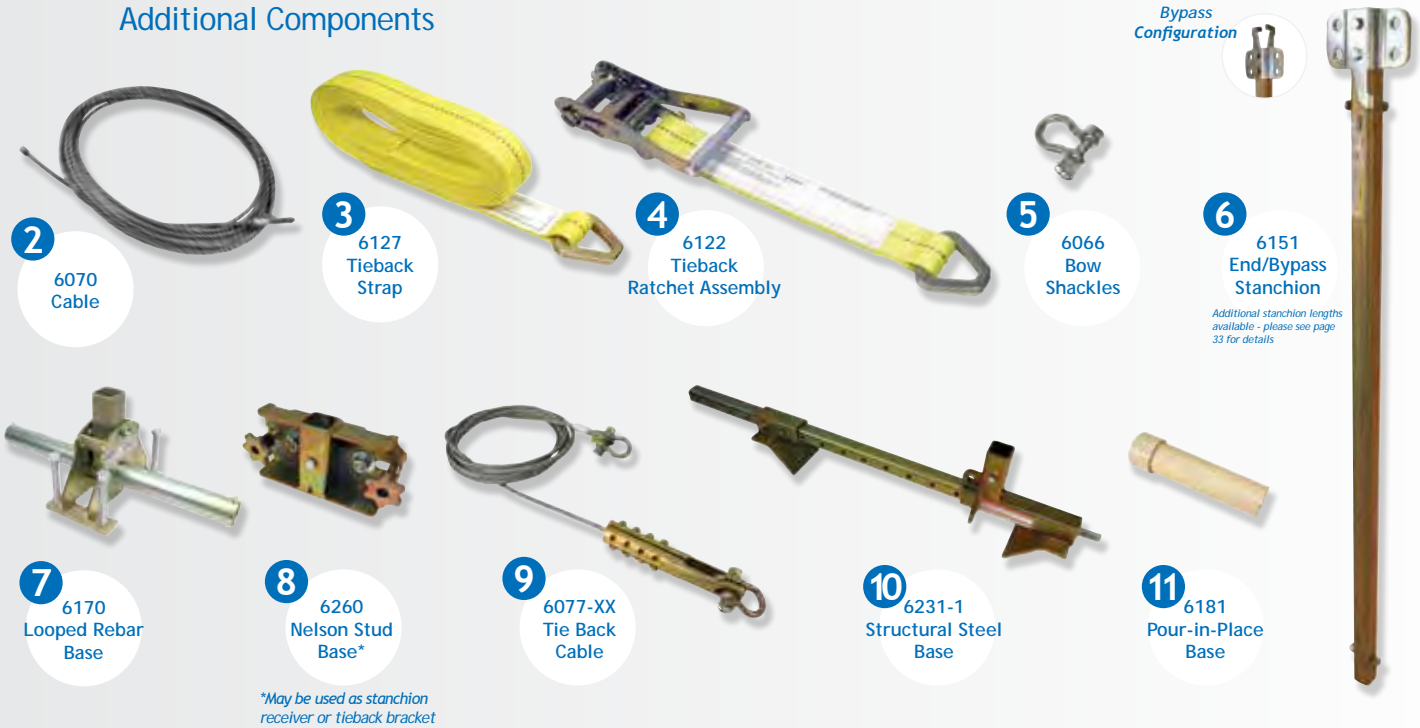

## Structural Steel for Bridge Beams Systems

Designed to clamp to existing beams without modification or welding. Most beams can be accommodated with the 6230 or 6231 clamp.

Custom sizes available.

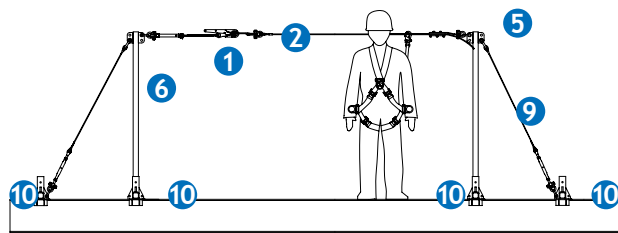

- 6310 Horizontal Lifeline Kit
- 6070-XXX 3/8" (10mm) 7x19 galvanized cable-specify length (6072=stainless cable)
- 6077-XX X 2 Tie-Back Cable
- 6066 X 4 Stainless Bow shackles

At least two of each of the following :

- 6151 60" (1.5m) Combo End/Bypass Stanchion\*

At least two of each of the following (4 per system):

- 6231 11" - 38" (28 - 96.5cm) capacity base (additional sizes available)

\*Additional bases and stanchions may be used for intermediate supports if necessary

## Pour-In-Place Concrete Insert System

6181 PVC Sleeves may be poured in place in the beams, end caps or other support structure. Sleeve is set 12" (30cm) into concrete. Please compensate stanchion height for the 12" insert.

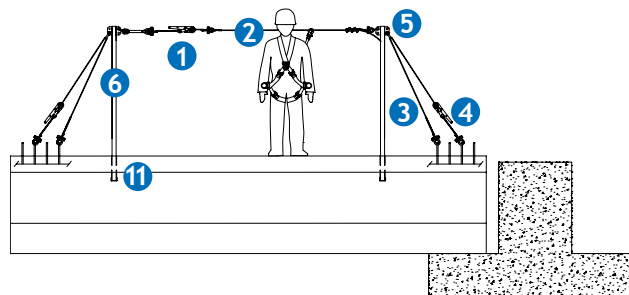

- 6310 Horizontal Lifeline Kit
- 6070-XXX 3/8" (10mm) 7x19 galvanized cable-specify length (6072=stainless cable)
- 6127 X 2 2" X 15" (50mm X 4.5m) tieback strap
- 6122 X 2 Tieback Ratchet Assembly
- 6066 X 6 Stainless Bow shackles

At least two of each of the following :

- 6151 60" (1.5m) Combo End/Bypass Stanchion\*
- 6181 Pour-in-Place Base

\*Additional bases and stanchions may be used for intermediate supports if necessary





Structural steel systems are designed for installation on existing structures. Utilizing off the shelf components, most all structures can be accommodated. System height is 5, 6, or 7' (1.5, 1.8, 2.1m) above the walking surface or can be configured to hang from above. System stabilization is maintained with tie-back cables or strong back struts when stanchions are utilized. On structures (piperacks) where clamping on the top flange of I- beams is not feasible, under slung clamps may be used.

## Clamp On System

Designed for direct clamping to existing beams without modification or welding. May be used in line with beams or mounted perpendicular. 6140 Strong Back or the 6141 Adjustable strong back may be used if tie backs are not available or work must be done up to the leading edge.

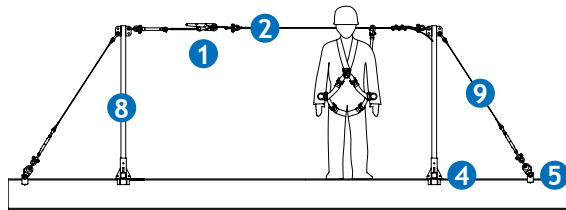

\*Additional bases and stanchions may be used for intermediate supports if necessary

- 6310 Horizontal Lifeline Kit
  - 6070-XXX 3/8" (10mm) 7x19 galvanized cable - specify length (6072=stainless cable)
- At least two of each of one the following :
- 6230/6231/6235/6240 structural steel base for stanchion support
  - 3093 structural steel anchor or 6231/6235/6240 structural steel base for tie-back anchor
- At least two of each of the following :
- 6151 60" (1.5m) H Combo End/Bypass Stanchion\*
  - 6077-XX Tie-Back Cable (XX = cable length)

## Weld On System

Designed for flat structures where beams are not available for clamping. May be installed at foot level or overhead. May be suitable for more permanent installations.

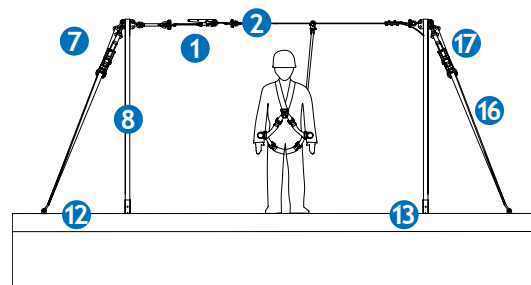

- 6310 Horizontal Lifeline Kit
- 6070-XXX 3/8" (10mm) 7x19 galvanized cable - specify length (6072=stainless cable)
- 6077-XX Tie-Back Cable (XX = cable length)
- 6066 X 6 Stainless Bow shackles

- At least two of each of the following :
- 6151 60" (1.5m) H Combo End/Bypass Stanchion\*
  - 6158 Weld-On anchor lug
  - 6154 Weld-On Receiver for stanchions

\*Additional bases and stanchions may be used for intermediate supports if necessary

## Choker Strap System

Quick and simple installation on to existing structure. Anchor straps can wrap around square or round structure. Lifeline elevation can be quickly changed or moved to a new location.

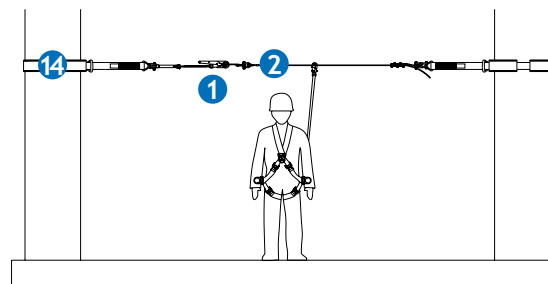

- 6310 Horizontal Lifeline Kit
- 6070-XXX 3/8" (10mm) 7x19 galvanized cable - specify length (6072=stainless cable)

- Two each of the following :
- 6095 Anchor Strap (custom lengths available)

## Structural Steel Systems : System Components



**1** 6310 Horizontal Lifeline System Components

### Additional Components

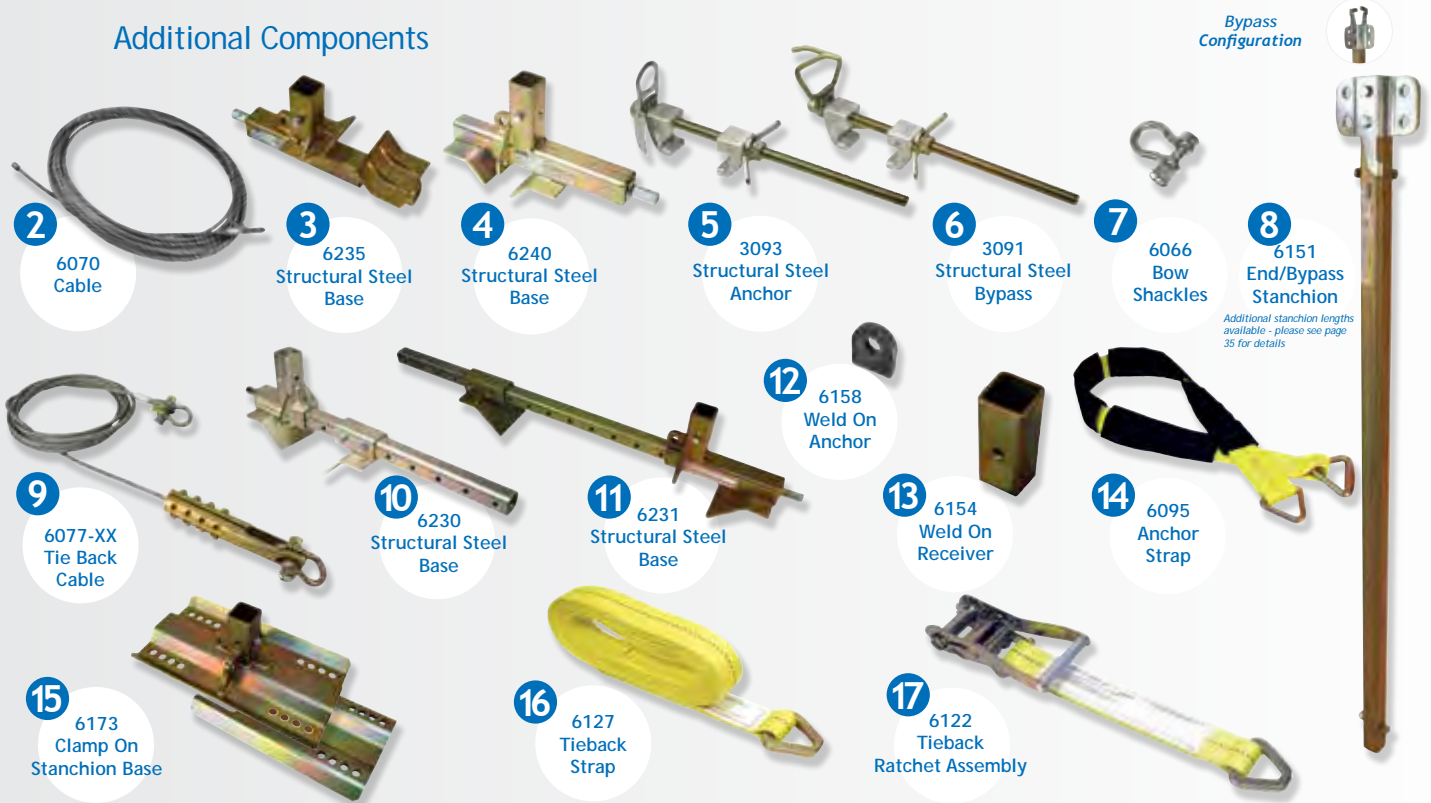

Bypass Configuration

Additional stanchion lengths available - please see page 35 for details

### Overhead System

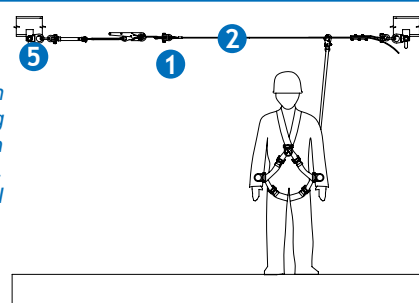

Utilizing the 3093 clamps, horizontal lifelines can be mounted overhead or adjacent to the walking working surface. Deflection can be reduced with the 3091 Intermediate Bypass support clamp. Long runs can be accomplished with the 3098 dual anchor clamp (not pictured).

- 6310 Horizontal Lifeline Kit
- 6070-XXX 3/8" (10mm) 7x19 galvanized cable - specify length (6072=stainless cable)
- Two each of the following :
  - 3093 Structural Steel Beam Anchor

### Fireproofed or Box Beam System

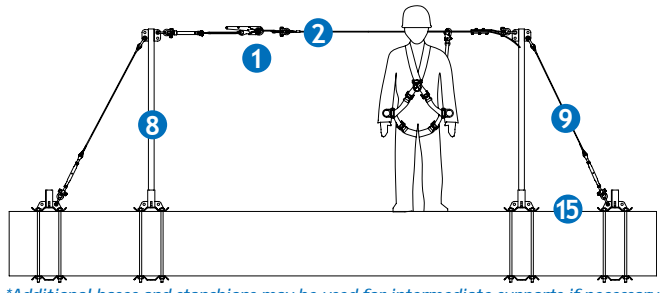

Installation of horizontal lifelines on enclosed beam and structure can be accomplished with the 6173 brackets. Most any thickness of beam can be accommodated using threaded rod. May be installed overhead.

- 6310 Horizontal Lifeline Kit
- 6070-XXX 3/8" (10mm) 7x19 galvanized cable - specify length (6072=stainless cable)
- At least two of each of the following :
  - 6151 60" (1.5m) H Combo End/Bypass Stanchion\*
  - 6077-XX Tie-Back Cable (XX = cable length)
- At least four of the following :
  - 6173 Clamp-On Stanchion Base (user supplies threaded rod for connecting upper & lower plates)

\*Additional bases and stanchions may be used for intermediate supports if necessary





Construction projects utilizing concrete foundations are among the most common in building sites worldwide. The nature of concrete construction projects presents a unique set of challenges for fall protection and horizontal lifeline setup and use. Reliance has extensive experience in this area, and offers a variety of systems and solutions for concrete construction projects.

Reliance has invested a great deal in engineering and Research and Development geared towards meeting the needs of our customers. Currently, Reliance offers several off the shelf systems which effectively address most concrete construction applications. Since each project has unique challenges, custom fabrication of brackets and structural interfaces are available upon request.

## Bolt In System

Threaded inserts or rods may be poured in place; or, on an existing structure, mechanical concrete fasteners may be drilled and installed to accept stanchion brackets and tie-back brackets. Can also be used with 6140 and 6141 StrongBacks™.

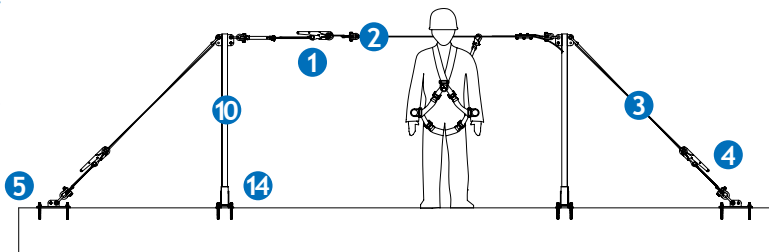

- 6310 Horizontal Lifeline Kit
- 6070-XXX 3/8" (10mm) 7x19 galvanized cable - specify length (6072=stainless)
- 6127 X 2 2" X 15' (50mm X 4.5m) tieback strap
- 6122 X 2 Tieback Ratchet Assembly
- 6066 X 6 Stainless Bow shackles

- At least 2 of each of one the following :
- 6151 60" (1.5m) Combo End/Bypass Stanchion\*
  - 6185-10 Stanchion Receiver For Rebar Dowel
  - 6200-22 Bolt-In Anchor Plate
- \*Additional bases and stanchions may be used for intermediate supports if necessary

## Commercial Rebar System

The Commercial Rebar System is designed to be installed on columns, piers or beams where rebar has been left stubbed up or protruding from the structure. 6166-1 Intermediate By-Pass Supports may be utilized to clamp to rebar to reduce deflection and end loading.

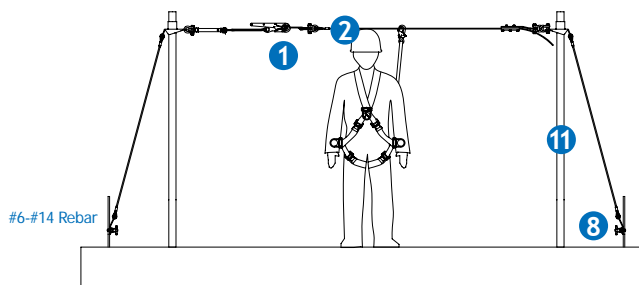

- 6310 Horizontal Lifeline Kit
- 6070-XXX 3/8" (10mm) 7x19 galvanized cable - specify length (6072=stainless)

- At least 2 of each of the following :
- 6200-23 - 60", 6210-23 - 72", or 6220-23 - 84" (1.5, 1.8, 2.1m) Stanchion Load Tubes
  - 6200-21 - 60", 6210-21 - 72", or 6220-21 - 84" (1.5, 1.8, 2.1m) Rebar Anchor Stanchion Head Assembly

## Drop In Sleeve System

6181 PVC sleeves may be poured in place on most any structure to accept stanchion tubes. Tie-back can be accomplished with exposed rebar, 6200-22 plates or 2250 concrete embed receivers.

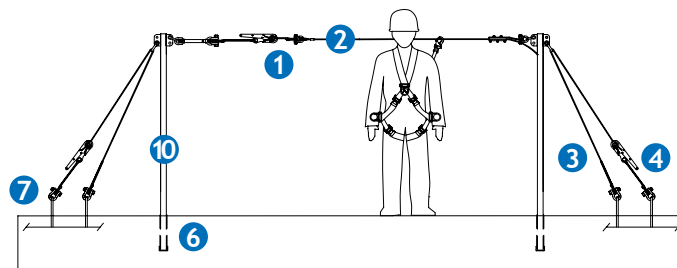

- 6310 Horizontal Lifeline Kit
- 6070-XXX 3/8" (10mm) 7x19 galvanized cable - specify length (6072=stainless)
- 6127 X 2 2" X 15' (50mm X 4.5m) tieback strap
- 6122 X 2 Tieback Ratchet Assembly
- 6062-1 X 4 Stainless Bow shackles
- 6066 X 2 Stainless Bow shackles

- At least 2 of each of one the following :
- 6151 60" (1.5m) Combo End/Bypass Stanchion\*
  - 6181 Pour-In-Place Base

\*Additional bases and stanchions may be used for intermediate supports if necessary

## Concrete Systems : System Components



### Rebar Direct Connect System

Exposed rebar may be used to connect a Horizontal Lifeline System to a structure while installing or removing forms. Utilizing the 6200-11 or -14 anchor and the 3800-xx tie back anchor plates, system installation is simple and flexible.

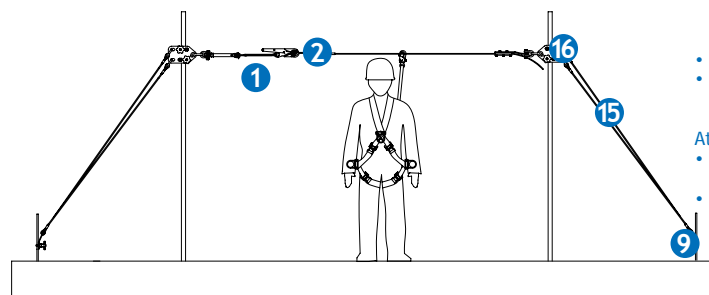

- 6310 Horizontal Lifeline Kit
  - 6070-XXX 3/8" (10mm) 7x19 galvanized cable - specify length (6072=stainless)
- At least 2 of each of the following :
- 6200-011 (#8-#11 Rebar) or 6200-014 (#12 #14 Rebar) Rebar Tie-Back Anchor Plate
  - 3088-011 (#8-#11 Rebar) 3088-014 (#12 #14 Rebar) HLL Rebar Anchor Assembly

### Embedded System

The concrete embed system is a cast in place concrete anchor system for personal fall arrest and horizontal lifeline anchorage applications. It is composed of a receiver that is cast into the concrete and secured with rebar to provide over 10,000 lbs of pull out strength when loaded in any direction. Receivers can be installed on any type of concrete forming applications from metal decking to columns, ceiling beams, rooftops, and exterior siding.

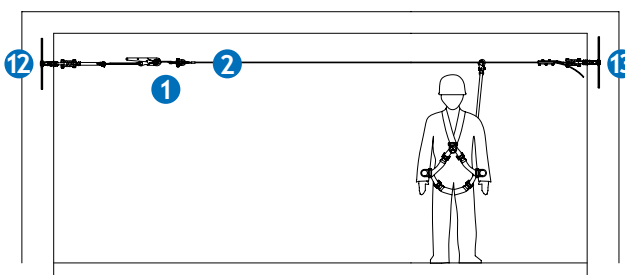

- 6310 Horizontal Lifeline Kit
  - 6070-XXX 3/8" (10mm) 7x19 galvanized cable - specify length (6072=stainless)
- At least 2 of each of the following :
- 2260 Concrete Embed connector
  - 2250 Zinc Receiver (2252 Stainless)





With our large selection of off the shelf components, most any structure may be fitted with a permanent or temporary Reliance horizontal lifeline. With the ability to “tune” our lifeline systems, Reliance can accommodate clearance and span geometries that our competitors have difficulty with.

## Inverted 'L' System

Inverted “L”s are a permanent HLL solution for rail car and over the road tanker loading and unloading terminals. With enough clearance, spans of up to 200' (61m) can be accomplished.

Note: Reliance is not the manufacturer of the 'L' structures. We provide for purchase, a complete set of PE stamped engineering and shop drawings for local fabrication by the customer.

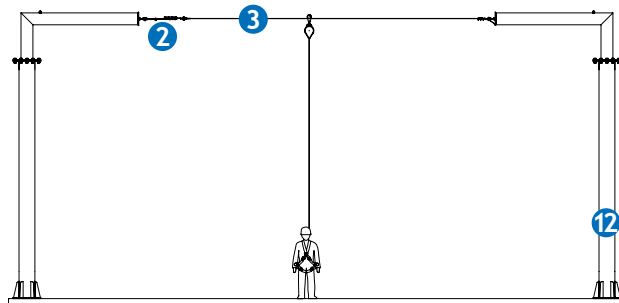

- 6070-XXX 3/8" (10mm) 7x19 galvanized cable - specify length (6072=stainless)
- 6300 Shock absorber
- 6021-1 Rigging Screw
- 6055-1 Combo clamp
- 2 each 6062-1 1/2" (12mm) bow shackle
- 6066 5/8" (15mm) bow shackle
- 6082-1 3/8" (10mm) wire rope clip & at least 2 of the inverted L's



"Inverted L" Installation



"StrongBack™" Rooftop Installation

## "StrongBack™" System

StrongBack™ installation allows for horizontal lifeline installation when the use of tie back cables is not possible. Strongbacks can also be utilized with weld on receivers, and allow for leading edge access.

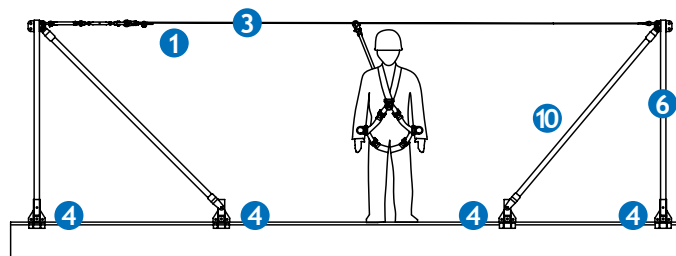

- 6310 Horizontal Lifeline Kit
- 6070-XXX 3/8" (10mm) 7x19 galvanized cable - specify length (6072=stainless)
- 4 each 6230, 6231, 6235, or 6240 clamps
- 2 each 6140 or 6141 StrongBack™
- 2 each 6151 Stanchion

## Speciality Systems : System Components



6092  
Ratchet Strap



6050  
In Line  
Cable Clamp



6000  
In Line Energy  
Absorber

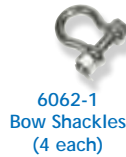

6062-1  
Bow Shackles  
(4 each)

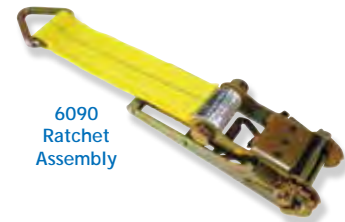

6090  
Ratchet  
Assembly

### 1 6310 Horizontal Lifeline System Components

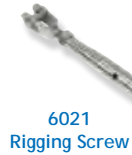

6021  
Rigging Screw



6055  
3/8" (10mm) Wire  
Rope Combo Clamp



6000  
In Line Energy  
Absorber



6062-1  
Bow Shackles  
(2 each)



6066  
Bow Shackles  
(1 each)



6082  
3/8" (10mm) Wire  
Rope Clip

### 2 6300 Permanent Horizontal Lifeline System Components



3 6070  
Cable



4 6230  
Structural Steel  
Base



5 6231  
Structural Steel  
Base

Bypass  
Configuration



6 6151  
End/Bypass  
Stanchion

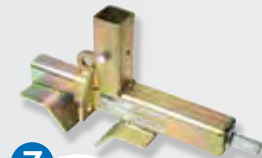

7 6240  
Structural Steel  
Base



8 6235  
Structural Steel  
Base



9 6154  
Weld On  
Receiver



10 6141  
Adjustable  
StrongBack™  
Stanchion



10 6140  
StrongBack™  
Stanchion

12  
Inverted  
'L'



Note: Reliance is not the manufacturer of the 'L' structures. We provide for purchase, a complete set of PE stamped engineering and shop drawings for local fabrication by the customer.





# Horizontal Lifeline System Components



## Universal System Components

Items listed on the following two pages are system components that are used in virtually every type of Reliance Horizontal Lifeline System, regardless of application. Please note that many of these items are NOT sold individually, only as part of a system. Contact Reliance for more details.



5100 - 3/8" (10mm) Pulley with Stainless Steel Side Plates



5102-1 - 1/2" (13mm)  
5103 - 5/8" (16mm)  
3/8" (10mm) Cable Bow Shackle Pulley



3074 - Bolt-On D-Ring Anchor

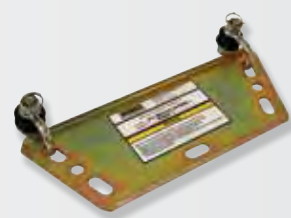

5200 - HLL Rescue Ladder Mounting Bracket

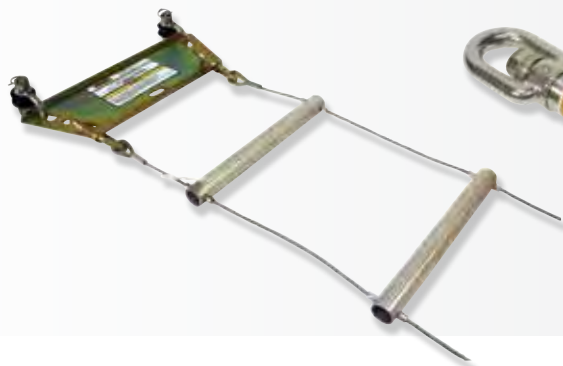

5230 - 30' (9.1m) Wire Rope Ladder for HLL rescue (bracket not included)



6000-1 - Skyline Shock Absorber



6021 - Stainless  
6022-1 - Galvanized  
20mm Jaw & Jaw Rigging Screw



6050 - Inline Cable Clamp, Yellow Zinc



6051 - 1/2" (13mm) Inline Clamp, Cast (bow shackle not included)



6052 - Inline Cable Clamp, Stainless



6055 - 3/8" (10mm) Combination Clamp

# Horizontal Lifeline System Components



6062-1 - 1/2" (13mm) Stainless  
6066 - 5/8" (16mm) Stainless  
6063 - 1/2" (13mm) Galvanized  
6067-1 - 5/8" (16mm) Galvanized  
Forged Bow Shackle



6070-XX Galvanized  
6072-XX Stainless  
(XX denotes length)  
3/8" (10mm) -7x19 Cable



6077-XX - Adjustable Tie-back Cable, 1/2" (13mm) - 6x19 (XX denotes length)



6082 - 3/8" (10mm) Stainless Wire Rope Clip



6090 - 3" (7.6cm) Ratchet with strapping and anchor triangle hardware



6092 - 3" (7.6cm) Ratchet Strap



6122 - 2" (5cm) Ratchet With Strapping and Anchor Triangle Hardware



6127 - 2" x 10ft (5cm X 3m) Ratchet Strap

\*6076 - Kit that contains both 6120 & 6122



Bypass Configuration

6151 - 60" (1.5m)  
6178 - 72" (1.8m)  
6163 - 84" (2.1m)  
End / By-Pass Stanchion



6096 - 15' (4.5m)  
6095 - 6' (1.8m)  
Anchor Strap



6125 - 3" (7.6cm) Ratchet with 6000 -1 Shock Absorber & 2 ea. 6062-1 - Bow Shackles



6461 - Stainless Dual Wheel, Hands-Free Traveler



6452 - Stainless Steel Hands Free By-Pass Support







# Horizontal Lifeline System Components



## Concrete System Components

Items listed here are system components that are typically used in Reliance's Concrete Horizontal Lifeline Systems. Please note that these items may not be sold individually, only as part of a system. Contact Reliance for more details.



6166 - Rebar By-Pass Assembly



6181 - Drop-In Sleeve for Stanchion



6170 - Looped Rebar Receiver Bracket



6173 - Concrete Beam Receiver Base (Upper And Lower Plate)



6172 - Ratchet Strap Bypass Assembly

6260 - 7-3/8" to 7-5/8" (18.7 to 19.3cm) Nelson Stud Bracket Base  
*Large selection of sizes available*



6200-23 - 60" (1.5m)  
6210-23 - 72" (1.8m)  
6220-23 - 84" (2.1m)  
Concrete Rebar Stanchion



6200-21 - 60" (1.5m)  
6210-21 - 72" (1.8m)  
6220-21 - 84" (2.1m)  
Rebar Stanchion Cable Head assembly



6200-011 - #6-#11 Rebar  
6200-014 - #14 Rebar  
Rebar Tie-Back Anchor Plate



3088-011 - #6-#11 Rebar  
3088-014 - #12-#14 Rebar  
HLL Rebar Anchor Assembly





## Structural Steel System Components

Items listed here are system components that are typically used in Reliance's Structural Steel Horizontal Lifeline Systems. Please note that these items may not be sold individually, only as part of a system. Contact Reliance for more details.



3091 - HLL Bypass Beam Clamp fits  
4" - 16 5/8" width  
1/4" - 1 3/4" thick  
(4 - 41.5cm width  
.6 - 4.4cm thick)



3092 - HLL Foot Rest Beam Clamp fits  
4" - 16 5/8" width  
1/4" - 1 3/4" thick  
(4 - 41.5cm width  
.6 - 4.4cm thick)



3093 - HLL Anchorage Beam Clamp fits  
4" - 16 5/8" width  
1/4" - 1 3/4" thick  
(4 - 41.5cm width  
.6 - 4.4cm thick)



3098 - HLL Double End Anchorage Beam Clamp fits  
4" - 16 5/8" width  
1/4" - 1 3/4" thick  
(4 - 41.5cm width  
.6 - 4.4cm thick)



6230 - HLL Stanchion Beam Clamp fits  
6" - 28" width  
1/2" - 2" thick  
(28 - 71cm width  
(1.2 - 5cm thick)



6231 - HLL Stanchion Beam Clamp fits  
11" - 38" width  
1/2" - 3" thick  
(28 - 96cm width  
1.2 - 7.6cm thick)



6240 - HLL Stanchion Beam Clamp fits  
4 1/2" - 14" width  
1/2" - 1 1/2" thick  
(11.4 - 35.5cm width  
1.2 - 3.8cm thick)



6235 - HLL Stanchion Inverted Beam Clamp fits  
4 1/2" - 14" width  
1/2" - 1 1/2" thick  
(11.4 - 35.5cm width  
1.2 - 3.8cm thick)



6167 - Weld-On By-Pass



6158 - Galvanized  
6160 - Stainless  
Single Hole Weld-on Anchorage Lug

6161 - Galvanized  
6162 - Stainless  
Double Hole Weld-on Anchorage Lug

6140-1 - Standard  
6142-1 - Narrow  
Strong Back, 82" (2m)



6141-1 - Adjustable  
Strong Back, 82" (2m)



# Horizontal Lifeline System Components Chart

SKU	Description	UOM	Price
REL3074	Bolt-on D-ring anchor	EA	\$44.29
REL3088-011	#6-#11 Rebar, HLL rebar anchor assembly	EA	\$367.18
REL3088-014	#12-114 Rebar, HLL rebar anchor assembly	EA	\$405.84
REL3091	HLL Bypass Beam Clamp fits 4"-16 5/8" width, 1/4" - 1 3/4" thick	EA	\$465.50
REL3092	HLL Foot Rest Beam Clamp fits 4"-16 5/8" width, 1/4" - 1 3/4" thick	EA	\$464.21
REL5100	3/8" (10mm) pulley with stainless steel side plates	EA	\$138.31
REL5104	5/8" (13mm) 3/8" (10mm) cable bow shackle pulley	EA	\$70.80
REL5200	HLL rescue ladder mounting bracket	EA	\$245.57
REL5230	30' (9.1m) Wire rope ladder for HLL rescue	EA	\$1148.11
REL6000-1	Skyline shock absorber	EA	\$321.01
REL6021	Stainless 20mm jaw & jaw rigging screw	EA	\$149.97
REL6022-1	Galvanized jaw & jaw rigging screw	EA	\$93.22
REL6050	Inline cable clamp, yellow zinc	EA	\$203.57
REL6051	1/2" (13mm) inline clamp, cast	EA	\$351.42
REL6052	Inline cable clamp, stainless	EA	\$307.36
REL6055	3/8" (10mm) combination clamp	EA	\$113.49
REL6062-1	1/2" (13mm) stainless forged bow shackle	EA	\$23.08
REL6063	1/2" (13mm) galvanized forged bow shackle	EA	\$17.72
REL6066	5/8" (16mm) stainless forged bow shackle	EA	\$46.94
REL6067-1	5/8" (13mm) galvanized forged bow shackle	EA	\$32.58
REL6070-XX	Galvanized 3/8" (10mm) -7x19 cable	EA	Call
REL6072-XX	Stainless 3/8" (10mm) -7x19 cable	EA	Call
REL6076	Ratchet Strap Kit	EA	\$117.97
REL6077-XX	Adjustable tieback cable, 1/2" (13mm) - 6x19	EA	Call
REL6082	3/8" (10mm) stainless wire rope clip	EA	\$7.69
REL6090	Ratchet with strapping and anchor triangle hardware	EA	\$110.58
REL6092	3" (7.6cm) ratchet strap	EA	\$85.81
REL6093	HLL Anchorage Beam Clamp fits 4"-16 5/8" width, 1/4" - 1 3/4" thick	EA	\$61.65
REL6095	6' (1.8m) Anchor strap	EA	\$121.53
REL6096	15' (4.5m) Anchor strap	EA	\$166.05
REL6098	HLL Double End Anchorage Beam Clamp fits 4"-16 5/8" width, 1/4" - 1 3/4" thick	EA	\$183.91
REL6120	2" x 10ft (5cm X 3m) ratchet strap	EA	\$39.43
REL6122	2" (5cm) Ratchet with strapping and anchor triangle hardware	EA	\$40.27
REL6125	3" (7.6cm) Ratchet with 6000-1 Shock Absorber & 2 ea. 6062-1 bow shackles	EA	\$387.45
REL6127	HLL Dual Tie-Back Strapping 2" X 15 FT	EA	\$56.47
REL6140-1	Standard Strong Back, 82" (2m)	EA	\$451.65
REL6141-1	Adjustable Strong Back, 82" (2m)	EA	\$525.58
REL6142-1	Narrow Strong Back, 82" (2m)	EA	\$402.61
REL6151	60" (1.5m) End / By-Pass stanchion	EA	\$167.56
REL6154	Weld on receiver	EA	\$44.01
REL6158	Galvanized single hole weld-on anchorage lug	EA	\$14.74
REL6160	Stainless single hole weld-on anchorage lug	EA	\$51.25
REL6161	Galvanized double hole weld-on anchorage lug	EA	\$16.94
REL6162	Stainless double hole weld-on anchorage lug	EA	\$93.82
REL6163	84" (2.1m) End / By-Pass stanchion	EA	\$201.34
REL6166-014	Rebar By-Pass assembly for #12-14 rebar	EA	\$137.82
REL6167	Weld-On By-Pass	EA	\$72.19
REL6170	Looped rebar receiver bracket	EA	\$418.51
REL6172	Ratchet strap bypass assembly	EA	\$138.78
REL6173	Concrete Beam receiver base (upper and lower plate)	EA	\$724.00
REL6178	72" (1.8m) End / By-Pass stanchion	EA	\$188.45
REL6181	Drop-In Sleeve for stanchion	EA	\$12.00
REL6185	Stanchion Receiver For Rebar Dowel	EA	\$196.64
REL6200-011	#6-#11 Rebar, rebar tie-back anchor plate	EA	\$72.64
REL6200-014	#14 Rebar, rebar tie-back anchor plate	EA	\$72.64
REL6200-21	60" (1.5m) Rebar stanchion cable head assembly	EA	\$534.55
REL6200-23	60" (1.5m) Concrete rebar stanchion	EA	\$198.30
REL6210-21	72" (1.5m) Rebar stanchion cable head assembly	EA	\$351.69
REL6210-23	72" (1.5m) Concrete rebar stanchion	EA	\$229.30
REL6220-21	84" (1.5m) Rebar stanchion cable head assembly	EA	\$360.07
REL6220-23	84" (1.5m) Concrete rebar stanchion	EA	\$247.67
REL6230	HLL Stanchion Beam Clamp fits 6"-28" width, 1/2" - 2" thick	EA	\$664.21
REL6231-1	6231 - HLL Stanchion Beam Clamp fits 11"-38" width, 1/2" - 3" thick	EA	\$685.16
REL6235	HLL Stanchion Inverted Beam Clamp fits 4 1/2"-14" width, 1/2" - 1 1/2" thick	EA	\$692.14
REL6240	HLL Stanchion Beam Clamp fits 4 1/2"-14" width 1/2" - 1 1/2" thick	EA	\$541.74
REL6260	7-3/8" to 7-5/8" (18.7 to 19.3cm) Nelson Stud Bracket Base	EA	\$225.00
REL6452	Stainless steel hands free by-pass support	EA	\$187.98
REL6461	Stainless dual wheel, hands- free traveler	EA	\$525.82



## *Inspectable*

- Tattletale® webbing has an interior ply of contrasting bright red "strength" yarns that increase webbing strength to 7000 lbs (31kN) and instantly reveal cuts or abrasion (see opposite page).
- Built-in impact load indicators
- Bar-coded individual serial numbers for traceability
- Indelible serial number in back plaque

## *Comfortable*

- "Floating" thigh stitching reduces binding
- Improved geometry brings buckles to front of thigh
- Angled stitching for "tailored" sub-pelvic fit
- Extra large back pad eliminates dangerous "D-ring droop"

## *Durable*

- No elastic webbing
- Heat-set labels won't come off
- Corrosion resistant grommets
- Extra thick woven (not sewn) seat webbing for added durability

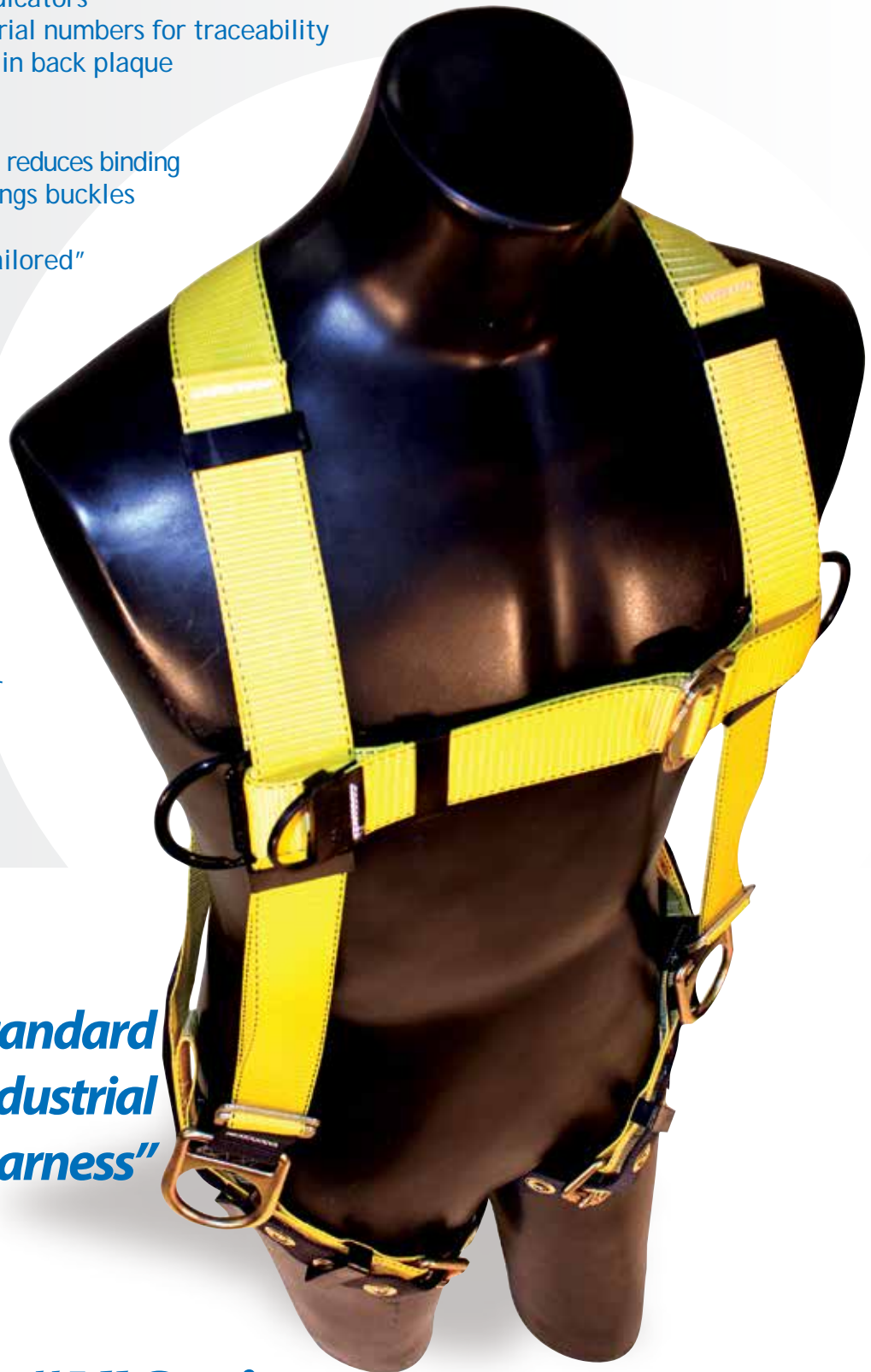

***"The industry standard  
construction & industrial  
Full Body Harness"***

## ***The "A" Series***







## What is TattleTale® Web?

TattleTale® web is inspectable web. All load-bearing straps in Reliance harnesses and lanyards have a red inner core (or a yellow core in black webbing) which becomes exposed when the web becomes damaged by cuts or abrasion. Red that shows through is not a "red light" signalling the user to stop using the equipment, it simply "tells" the user that the equipment needs closer inspection, and where to look. The webbing helps again by giving the Competent Person (the expert) the information needed to judge how deep the cuts or abrasions are, so the seriousness of the issue can be determined. Call Reliance at 800.330.9240 for complete inspection procedures.

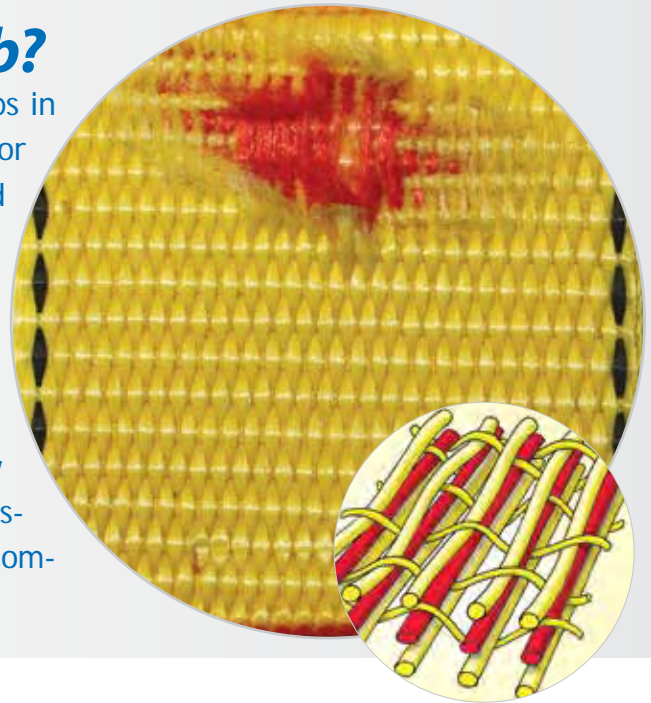

## "A" Series Harness Features

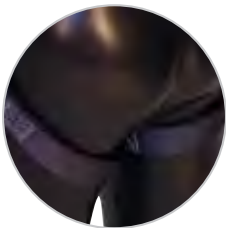

Extra-thick woven seat webbing



Extra-Large Back Pad



Corrosion Resistant Grommets



Improved Geometry



Built-In Impact Load Indicators



Lanyard Keepers on Chest Strap



## A. Reliance® "A" Series Harness 802000

- Vest style
- Back & side positioning D-rings
- Universal fit
- Tongue buckle thigh straps
- Polyester webbing

SKU	Description	Size	UOM	Price
REL802000	Harness "A" Series positioning	Standard	EA	\$73.56
REL802100	Harness "A" Series positioning	Small	EA	\$73.56
REL802400	Harness "A" Series positioning	X-Large	EA	\$73.56
REL802500	Harness "A" Series positioning	XX-Large	EA	\$80.91
REL802600	Harness "A" Series positioning	Big-Boy	EA	\$126.29

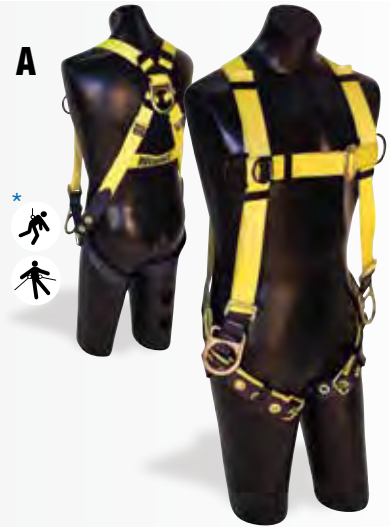

A



B

## B. Reliance® "A" Series Harness 800000

- Vest style
- Back D-ring
- Universal fit
- Tongue buckle thigh straps
- Polyester webbing

SKU	Description	Size	UOM	Price
REL800000	Harness "A" Series	Standard	EA	\$70.00
REL800100	Harness "A" Series	Small	EA	\$70.00
REL800400	Harness "A" Series	X-Large	EA	\$70.00
REL800500	Harness "A" Series	XX-Large	EA	\$79.39
REL800600	Harness "A" Series	Big-Boy	EA	\$123.86



C



## C. Reliance® "A" Series Harness 800006

- Back D-ring
- Universal fit
- Tongue buckle thigh straps
- Reflective tape front & back

SKU	Description	Size	UOM	Price
REL800006	Harness "A" Series w/ ref. tape	Standard	EA	\$77.03
REL800106	Harness "A" Series w/ ref. tape	Small	EA	\$86.61
REL800406	Harness "A" Series w/ ref. tape	X-Large	EA	\$86.61
REL800506	Harness "A" Series w/ ref. tape	XX-Large	EA	\$96.23
REL800606	Harness "A" Series w/ ref. tape	Big-Boy	EA	\$149.34



D

## D. Reliance® "A" Series Harness 803000

- Vest style
- Back, side positioning, & chest D-ring for climbing
- Universal fit
- Tongue buckle thigh straps
- Polyester webbing

SKU	Description	Size	UOM	Price
REL803000	Harness "A" Series climbing/positioning	Standard	EA	\$86.94
REL803100	Harness "A" Series climbing/positioning	Small	EA	\$86.94
REL803400	Harness "A" Series climbing/positioning	X-Large	EA	\$86.94
REL803500	Harness "A" Series climbing/positioning	XX-Large	EA	\$95.66
REL803600	Harness "A" Series climbing/positioning	Big-Boy	EA	\$149.20

\*See page 61 for a legend detailing icon usage



**A**

## A. Reliance® "A" Series Harness 802050

- Vest style
- Back & side positioning D-Rings
- Universal fit
- Pass-through mating buckles
- Polyester webbing

SKU	Description	Size	UOM	Price
REL802050	Harness "A" Series positioning	Standard	EA	\$69.61
REL802150	Harness "A" Series positioning	Small	EA	\$69.61
REL802450	Harness "A" Series positioning	X-Large	EA	\$69.61
REL802550	Harness "A" Series positioning	XX-Large	EA	\$76.57
REL802650	Harness "A" Series positioning	Big-Boy	EA	\$119.44

## B. Reliance® "A" Series Harness 803050

- Vest style
- Back, side positioning, & chest D-ring for climbing
- Universal fit
- Pass-through mating buckles
- Polyester webbing

SKU	Description	Size	UOM	Price
REL803050	Harness "A" Series climbing/positioning	Standard	EA	\$78.71
REL803150	Harness "A" Series climbing/positioning	Small	EA	\$78.71
REL803450	Harness "A" Series climbing/positioning	X-Large	EA	\$78.71
REL803550	Harness "A" Series climbing/positioning	XX-Large	EA	\$86.97
REL803650	Harness "A" Series climbing/positioning	Big-Boy	EA	\$135.81

**B****C**

## C. Reliance® "A" Series Harness 801000

- Vest style
- Back & chest D-ring for climbing
- Universal fit
- Tongue buckle thigh straps
- Polyester webbing

SKU	Description	Size	UOM	Price
REL801000	Harness "A" Series climbing	Standard	EA	\$84.77
REL801100	Harness "A" Series climbing	Small	EA	\$84.77
REL801400	Harness "A" Series climbing	X-Large	EA	\$84.77
REL801500	Harness "A" Series climbing	XX-Large	EA	\$93.24
REL801600	Harness "A" Series climbing	Big-Boy	EA	\$145.46

## D. Reliance® "A" Series Harness 809000

- Vest style - derrick
- Back, side positioning & climbing D-rings
- Universal fit
- Tongue buckle thigh straps
- Polyester webbing
- 18" (45cm) D-ring extender
- Belly board & saddle seat attachment buckles

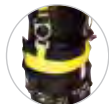
*885016 Belt - sold separately**885021 Belt - sold separately**885000 Seat - sold separately*

SKU	Description	Size	UOM	Price
REL809000	Harness "A" Series Oil Derrick	Standard	EA	\$89.22
REL809100	Harness "A" Series Oil Derrick	Small	EA	\$89.22
REL809400	Harness "A" Series Oil Derrick	X-Large	EA	\$89.22
REL809500	Harness "A" Series Oil Derrick	XX-Large	EA	\$99.12
REL809600	Harness "A" Series Oil Derrick	Big-Boy	EA	\$149.38

**D**

## A. Reliance® "A" Series Harness 804000

- Vest style
- Back, shoulder, D-rings
- Universal fit
- Tongue buckle thigh straps
- Polyester webbing

SKU	Description	Size	UOM	Price
REL804000	Harness "A" Series retrieval	Standard	EA	\$82.28
REL804100	Harness "A" Series retrieval	Small	EA	\$82.28
REL804400	Harness "A" Series retrieval	X-Large	EA	\$82.28
REL804500	Harness "A" Series retrieval	XX-Large	EA	\$90.51
REL804600	Harness "A" Series retrieval	Big-Boy	EA	\$141.23



## B. Reliance® "A" Series Harness 800050

- Vest style
- Back D-ring
- Universal fit
- Pass-through mating buckles

SKU	Description	Size	UOM	Price
REL800050	Harness "A" Series	Standard	EA	\$64.88
REL800150	Harness "A" Series	Small	EA	\$64.88
REL800450	Harness "A" Series	X-Large	EA	\$64.88
REL800550	Harness "A" Series	XX-Large	EA	\$71.37
REL800650	Harness "A" Series	Big-Boy	EA	\$111.32



## C. Reliance® "A" Series Harness 806000

- Vest style
- Back, side positioning, shoulder, & chest D-ring for climbing
- Universal fit
- Tongue buckle thigh straps
- Polyester webbing

SKU	Description	Size	UOM	Price
REL806000	Harness "A" Series climbing/positioning	Standard	EA	\$114.60
REL806100	Harness "A" Series climbing/positioning	Small	EA	\$114.59
REL806400	Harness "A" Series climbing/positioning	X-Large	EA	\$114.64
REL806500	Harness "A" Series climbing/positioning	XX-Large	EA	\$127.36
REL806600	Harness "A" Series climbing/positioning	Big-Boy	EA	\$197.58



## D. Reliance® "A" Series Harness 800002

- Vest style
- Universal fit
- Dielectric back D-ring
- Tongue buckle thigh straps
- Polyester webbing
- No exposed metal
- Sliding hardware cover

SKU	Description	Size	UOM	Price
REL800002	Harness "A" Series no exposed metal	Standard	EA	\$144.41
REL800102	Harness "A" Series no exposed metal	Small	EA	\$144.40
REL800402	Harness "A" Series no exposed metal	X-Large	EA	\$144.41
REL800502	Harness "A" Series no exposed metal	XX-Large	EA	\$151.63
REL800602	Harness "A" Series no exposed metal	Big-Boy	EA	\$196.10





## A. Reliance® "A" Series Harness 800005

- Vest style
- Back D-ring
- Universal fit
- Tongue buckle thigh straps
- .05" (1.2mm) Polyurethane coated webbing

SKU	Description	Size	UOM	Price
REL800005	Harness "A" Series	Standard	EA	\$119.51
REL800105	Harness "A" Series	Small	EA	\$103.42
REL800405	Harness "A" Series	X-Large	EA	\$112.06
REL800505	Harness "A" Series	XX-Large	EA	\$112.06
REL800605	Harness "A" Series	Big-Boy	EA	\$173.88

## B. Reliance® "A" Series Harness 801050

- Vest style
- Back & chest D-ring for climbing
- Universal fit
- Pass-through mating buckles
- Polyester webbing

SKU	Description	Size	UOM	Price
REL801050	Harness "A" Series climbing	Standard	EA	\$76.24
REL801150	Harness "A" Series climbing	Small	EA	\$76.24
REL801450	Harness "A" Series climbing	X-Large	EA	\$76.24
REL801550	Harness "A" Series climbing	XX-Large	EA	\$83.90
REL801650	Harness "A" Series climbing	Big-Boy	EA	\$130.96



## C. Reliance® "A" Series Harness 804050

- Vest style
- Back, shoulder, D-rings
- Universal fit
- Pass-through mating buckles
- Polyester webbing

SKU	Description	Size	UOM	Price
REL804050	Harness "A" Series retrieval	Standard	EA	\$74.07
REL804150	Harness "A" Series retrieval	Small	EA	\$74.07
REL804450	Harness "A" Series retrieval	X-Large	EA	\$74.07
REL804550	Harness "A" Series retrieval	XX-Large	EA	\$81.47
REL804650	Harness "A" Series retrieval	Big-Boy	EA	\$127.09

## A. Reliance® "A" Series Harness 800052

- Vest style
- Back D-ring
- Universal fit
- Pass-through mating buckles
- Kevlar®/Nomex® webbing

SKU	Description	Size	UOM	Price
REL800052	Harness "A" Series Kevlar®/Nomex®	Standard	EA	\$180.76
REL800152	Harness "A" Series Kevlar®/Nomex®	Small	EA	\$180.76
REL800452	Harness "A" Series Kevlar®/Nomex®	X-Large	EA	\$180.76
REL800552	Harness "A" Series Kevlar®/Nomex®	XX-Large	EA	\$278.32
REL800652	Harness "A" Series Kevlar®/Nomex®	Big-Boy	EA	\$325.87



## B. Reliance® "A" Series Harness 800051

- Vest style
- Dielectric back D-ring
- Universal fit
- Pass-through mating buckles
- PVC coated hardware with sliding covers
- Kevlar®/Nomex® webbing
- ASTM 877 compliant

SKU	Description	Size	UOM	Price
REL800051	Harness "A" Series Kevlar®/Nomex®	Standard	EA	\$207.86
REL800151	Harness "A" Series Kevlar®/Nomex®	Small	EA	\$207.85
REL800451	Harness "A" Series Kevlar®/Nomex®	X-Large	EA	\$207.86
REL800551	Harness "A" Series Kevlar®/Nomex®	XX-Large	EA	\$230.95
REL800651	Harness "A" Series Kevlar®/Nomex®	Big-Boy	EA	\$358.37

## C. Reliance® "A" Series Harness 802005

- Vest style
- Back & side positioning D-rings
- Universal fit
- Tongue buckle thigh straps
- .05" (1.2mm) Polyurethane coated webbing

SKU	Description	Size	UOM	Price
REL802005	Harness "A" Series positioning	Standard	EA	\$104.08
REL802105	Harness "A" Series positioning	Small	EA	\$89.00
REL802405	Harness "A" Series positioning	X-Large	EA	\$90.45
REL802505	Harness "A" Series positioning	XX-Large	EA	\$135.33
REL802605	Harness "A" Series positioning	Big-Boy	EA	\$141.73







**A**

## A. Reliance® "A" Series Harness 802055

- Vest style
- Back D-ring
- Universal fit
- Pass-through mating buckles
- .05" (1.2mm) Polyurethane coated webbing

SKU	Description	Size	UOM	Price
REL802055	Harness "A" Series	Standard	EA	\$120.05
REL802155	Harness "A" Series	Small	EA	\$85.05
REL802455	Harness "A" Series	X-Large	EA	\$120.05
REL802555	Harness "A" Series	XX-Large	EA	\$120.05
REL802655	Harness "A" Series	Big-Boy	EA	\$216.89

## B. Reliance® "A" Series Harness 802006

- Vest style
- Back D-ring
- Universal fit
- Tongue buckle thigh straps
- Polyester webbing
- Reflective tape front & back

SKU	Description	Size	UOM	Price
REL802006	Harness "A" Series climbing/positioning	Standard	EA	\$88.26
REL802106	Harness "A" Series climbing/positioning	Small	EA	\$88.26
REL802406	Harness "A" Series climbing/positioning	X-Large	EA	\$104.81
REL802506	Harness "A" Series climbing/positioning	XX-Large	EA	\$95.62
REL802606	Harness "A" Series climbing/positioning	Big-Boy	EA	\$140.99



**B**



**C**

## C. Reliance® "A" Series Harness 841000

- Pullover style
- Back, front D-rings
- Side positioning O-rings
- Universal fit
- Tongue buckle thigh straps
- Polyester webbing

SKU	Description	Size	UOM	Price
REL841000	Harness "A" Series climbing/positioning	Standard	EA	\$81.60
REL841100	Harness "A" Series climbing/positioning	Small	EA	\$81.59
REL841400	Harness "A" Series climbing/positioning	X-Large	EA	\$81.60
REL841500	Harness "A" Series climbing/positioning	XX-Large	EA	\$100.38
REL841600	Harness "A" Series climbing/positioning	Big-Boy	EA	\$140.68



\* Please Note : Harnesses sized as follows : 8XX1XX = Small, 8XX4XX = X-Large, 8XX5XX = XXL, 8XX6XX = Big Boy

## "A" Series Full Body Harnesses

SKU	Style	D-Rings	Connectors	Material	Other
REL800000	Vest	Back	Tongue Buckle	Polyester Web	Universal Fit
REL800002	Vest	Dielectric Back	Tongue Buckle	Polyester Web	No metal above waist/ Sliding Covers
REL800005	Vest	Back	Tongue Buckle	Polyurethane Coated	Universal Fit
REL800006	Vest	Back	Tongue Buckle	Polyurethane Coated	Reflective Tape Front/Back
REL800050	Vest	Back	Pass-Through	Polyester Web	Universal Fit
REL800051	Vest	Dielectric Back	Pass-Through	Kevlar®/Nomex®	Coated Hardware with Sliding Covers
REL800052	Vest	Back	Pass-Through	Kevlar®/Nomex®	Universal Fit
REL800055	Vest	Back	Pass-Through	Polyurethane Coated	Universal Fit
REL801000	Vest	Back, Chest	Tongue Buckle	Polyester	Universal Fit
REL801050	Vest	Back, Chest	Pass-Through	Polyester	Universal Fit
REL802000	Vest	Back, Side	Tongue Buckle	Polyester	Universal Fit
REL802005	Vest	Back, Side	Tongue Buckle	Polyurethane Coated	Universal Fit
REL802006	Vest	Back, Side	Tongue Buckle	Polyester	Reflective Tape Front/Back
REL802010	Vest	Back, Side	Tongue Buckle	Polyester	Includes 'X' Comfort Pad
REL802050	Vest	Back, Side	Pass-Through	Polyester	Universal Fit
REL803000	Vest	Back, Side, Chest	Tongue Buckle	Polyester	Universal Fit
REL803050	Vest	Back, Side, Chest	Pass-Through	Polyester	Universal Fit
REL804000	Vest	Back, Shoulder	Tongue Buckle	Polyester	Universal Fit
REL804050	Vest	Back, Shoulder	Pass-Through	Polyester	Universal Fit
REL806000	Vest	Back, Side, Shoulder, Chest	Tongue Buckle	Polyester	Universal Fit
REL809000	Vest	Back, Side, Climbing	Tongue Buckle	Polyester	18" (45cm) D-Ring Extender, Belly Board & Saddle Seat Attachments
REL841000	Pullover	Back, Front, Side O's	Tongue Buckle	Polyester	Universal Fit
REL898001	Vest	N/A	Pass-Through	Polyester	Harness/Lanyard Combination
REL898002	Vest	N/A	Tongue Buckle	Polyester	Harness/Lanyard Combination
REL898003	Vest	N/A	Pass-Through	Polyester	Harness/Lanyard Combination
REL898004	Vest	N/A	Pass-Through	Polyester	Harness/Lanyard Combination

## Harness Buckle Types

All Reliance 'A' Series and Ironman™ Series full body harnesses utilize one of two types of fasteners to secure the lower leg portion of the harness (all chest straps are secured using pass-thru buckles)



**Tongue Buckle Fasteners**

Tongue buckle and grommet fasteners are corrosion resistant to ensure smooth, consistent operation. Grommets are inserted through an opening in the web as opposed to a punched hole to maintain webbing integrity. Consistent spacing ensures a custom fit regardless of user size. Harness sizing adjustment is easy, especially when wearing gloves.



**Pass-Thru Fasteners**

Pass-Thru buckles are zinc-coated and smooth for a precise fit. Placement of the web through the buckle provides for a higher degree of custom adjustment than grommet and tongue buckle fasteners, and use of Pass-Thru buckles reduce the overall weight of the harness. Pass-Thru buckles are standard chest strap fasteners on all Reliance harnesses.





# IRONMAN LITE



**The Ironman™ Lite Harness  
from Reliance. Designed for  
hard work - and now 10% -  
30% lighter...**

***Higher Standards in Fall Protection***





## The Reliance Ironman™ Lite series: Ideal for use in heavy construction, maintenance, and in harsh environments.

### Inspectable

- TattleTale® webbing has an interior ply of contrasting black “strength” yarns that increase webbing strength to 7000 lbs (31kN) and instantly reveal cuts or abrasion
- Built-in impact load indicators
- Bar-coded individual serial numbers for traceability

### Comfortable

- Removable back support/tool belt, shoulder padding
- Reliance Quick-Adjust™ torso adjustment buckles
- Quick-Connect chest buckle
- “Floating” thigh stitching reduces binding
- Improved geometry places buckles on front of thigh
- Angled stitching for “tailored” sub-pelvic fit
- Extra large back pad eliminates dangerous ‘D-ring droop



### Durable

- No elastic webbing
- Heat-set labels won't come off
- Extra heavy-duty corrosion and abrasion resistant leg grommets
- Extra thick woven (not sewn) seat webbing for added durability
- Premium anodized aluminum alloy hardware for high strength and reduced weight

*Ideal for use with the*

*Reliance StopLite®*

## Ironman™ Lite Features



**Aluminum Torso Adjustors**



**Aluminum Positioning D-Rings (802000)**



**Integrated Back Belt (812000)**

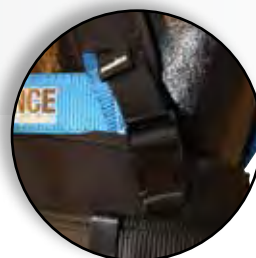

**Back Belt Position Adjustors**

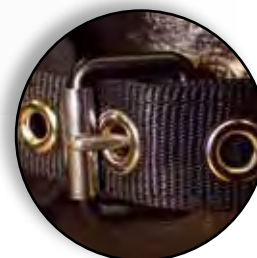

**Anodized Aluminum Tongue Buckles**



**Stand-Up Aluminum Dorsal D-Ring**



**Aluminum Positioning D-Rings (812000)**

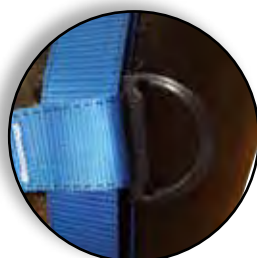

**Dual Lanyard Keepers**



**Slim Profile Quick Connect Chest Buckle**

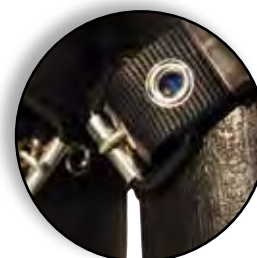

**Silver Aluminum Grommets**







# Ironman™ Lite Harness

Ironman™ Lite is a new grade of harness designed for the power-user, combining premium features with the classic utility of Reliance Full Body Harnesses. The aluminium alloy hardware provides the strength of steel without the weight, ensuring greater comfort and increased compliance and productivity.



**A**

## A. Reliance® Ironman™ Lite Harness 800000-A

- Vest style
- Polyester webbing
- Tongue buckle leg straps
- Single dorsal D-Ring for fall arrest

SKU	Description	Size	UOM	Price
REL800000-A	Vest style with back D-Ring	Universal	EA	\$136.00

## B. Reliance® Ironman™ Lite Harness 802000-A

- Vest style
- Polyester webbing
- Tongue buckle leg straps
- Single dorsal D-Ring for fall arrest
- Hip D-Rings for work positioning

SKU	Description	Size	UOM	Price
REL802000-A	Vest style with back and hip D-Ring	Universal	EA	\$167.00
REL802100-A	Vest style with back and hip D-Ring	Small	EA	\$167.00
REL802400-A	Vest style with back and hip D-Ring	X-Large	EA	\$167.00
REL802500-A	Vest style with back and hip D-Ring	XX-Large	EA	\$169.00
REL802600-A	Vest style with back and hip D-Ring	Big-Boy	EA	\$169.00

**B**



**C**

## C. Reliance® Ironman™ Lite Harness 812000-A

- Vest style
- Polyester webbing
- Tongue buckle leg straps
- Single dorsal D-Ring for fall arrest
- Integrated adjustable/removable waist pad and belt
- Hip D-Rings for work positioning

SKU	Description	Size	UOM	Price
REL812000-A	Vest style with back and hip D-Ring	Universal	EA	\$211.00
REL812100-A	Vest style with back and hip D-Ring	Small	EA	\$211.00
REL812400-A	Vest style with back and hip D-Ring	X-Large	EA	\$211.00
REL812500-A	Vest style with back and hip D-Ring	XX-Large	EA	\$215.00
REL812600-A	Vest style with back and hip D-Ring	Big-Boy	EA	\$215.00

## D. Reliance® Ironman™ Lite Harness 825000-A

- Construction style
- Polyester webbing
- Tongue buckle leg straps
- D-rings for all arrest, positioning and climbing
- Includes detachable seat sling for suspension work and prolonged work-positioning

SKU	Description	Size	UOM	Price
REL825000-A	Tower-style harness with belt, back and hip D-rings and seat	Universal	EA	\$392.00

**D**



## A. Reliance® SteelHorse™ Harness 830000

- Vest-style harness
- Tongue buckle thigh straps
- Friction buckle torso strap adjuster
- Heavy-duty seat/leg webbing
- Polyester Tattletale torso webbing
- Neoprene label cover

SKU	Description	Size	UOM	Price
REL830000	Vest-style with back D-ring	Universal	EA	\$51.03
REL830100	Vest-style with back D-ring	Small	EA	\$51.03
REL830400	Vest-style with back D-ring	X-Large	EA	\$51.03
REL830500	Vest-style with back D-ring	XX-Large	EA	\$52.73
REL830600	Vest-style with back D-ring	Big-Boy	EA	\$56.05



## B. Reliance® SteelHorse™ Harness 842000

- Construction-style harness
- Padded waist-belt with positioning D-rings
- Tongue buckle thigh straps
- Friction buckle torso strap adjuster
- Heavy-duty seat/leg webbing
- Polyester Tattletale torso webbing
- Neoprene label cover

SKU	Description	Size	UOM	Price
REL842000	Construction-style with back and hip D-rings	Universal	EA	\$101.20
REL842100	Construction-style with back and hip D-rings	Small	EA	\$101.20
REL842400	Construction-style with back and hip D-rings	X-Large	EA	\$101.20
REL842500	Construction-style with back and hip D-rings	XX-Large	EA	\$102.89
REL842600	Construction-style with back and hip D-rings	Big-Boy	EA	\$104.59

## C. Reliance® SteelHorse™ Harness 845004

- Tower-style harness
- Padded waist-belt with positioning D-rings
- Heavy-duty suspension seat
- Tongue buckle thigh straps
- Friction buckle torso strap adjuster
- Heavy-duty seat/leg webbing
- Polyester Tattletale torso webbing
- Neoprene label cover

SKU	Description	Size	UOM	Price
REL845004	Tower-style harness with belt, back and hip D-rings and seat	Universal	EA	\$224.50
REL845104	Tower-style harness with belt, back and hip D-rings and seat	Small	EA	\$224.50
REL845404	Tower-style harness with belt, back and hip D-rings and seat	X-Large	EA	\$224.50
REL845504	Tower-style harness with belt, back and hip D-rings and seat	XX-Large	EA	\$226.21
REL845604	Tower-style harness with belt, back and hip D-rings and seat	Big-Boy	EA	\$227.90







**A**

## A. Reliance® Ironman™ Harness 810000

- Ironman™ Harness
- Vest style
- Integrated work belt
- Back D-ring
- Universal fit
- Tongue buckle thigh straps
- Polyester webbing

SKU	Description	Size	UOM	Price
REL810000	Ironman™ Harness	Standard	EA	\$131.68
REL810100	Ironman™ Harness	Small	EA	\$131.68
REL810400	Ironman™ Harness	X-Large	EA	\$148.34
REL810500	Ironman™ Harness	XX-Large	EA	\$158.58
REL810600	Ironman™ Harness	Big-Boy	EA	\$199.59

## B. Reliance® Ironman™ Harness 811000

- Ironman™ Harness
- Vest style
- Integrated work belt
- Back D-ring, chest D-ring for climbing
- Universal fit
- Tongue buckle thigh straps
- Polyester webbing

SKU	Description	Size	UOM	Price
REL811000	Ironman™ Harness Climbing	Standard	EA	\$153.65
REL811100	Ironman™ Harness Climbing	Small	EA	\$153.65
REL811400	Ironman™ Harness Climbing	X-Large	EA	\$166.82
REL811500	Ironman™ Harness Climbing	XX-Large	EA	\$191.84
REL811600	Ironman™ Harness Climbing	Big-Boy	EA	\$231.35



**B**



**C**

## C. Reliance® Ironman™ Harness 812000

- Ironman™ Harness
- Vest style
- Integrated work belt
- Back & side positioning D-rings
- Universal fit
- Tongue buckle thigh straps
- Polyester webbing

SKU	Description	Size	UOM	Price
REL812000	Ironman™ Harness Positioning	Standard	EA	\$133.15
REL812100	Ironman™ Harness Positioning	Small	EA	\$133.15
REL812400	Ironman™ Harness Positioning	X-Large	EA	\$144.41
REL812500	Ironman™ Harness Positioning	XX-Large	EA	\$167.89
REL812600	Ironman™ Harness Positioning	Big-Boy	EA	\$209.58

## A. Reliance® Ironman™ Harness 813000

- Ironman™ Harness
- Vest style
- Integrated work belt
- Back, & side positioning D-rings, chest D-ring for climbing
- Universal fit
- Tongue buckle thigh straps
- Polyester webbing

SKU	Description	Size	UOM	Price
REL813000	Ironman™ Harness Climbing/Positioning	Standard	EA	\$153.61
REL813100	Ironman™ Harness Climbing/Positioning	Small	EA	\$153.61
REL813400	Ironman™ Harness Climbing/Positioning	X-Large	EA	\$165.47
REL813500	Ironman™ Harness Climbing/Positioning	XX-Large	EA	\$190.29
REL813600	Ironman™ Harness Climbing/Positioning	Big-Boy	EA	\$228.35



## B. Reliance® Ironman™ Harness 815000

- Ironman™ Harness
- Vest style
- Integrated work belt
- Back & side positioning D-rings
- Integrated suspension seat
- Universal fit
- Tongue buckle thigh straps
- Polyester webbing

SKU	Description	Size	UOM	Price
REL815000	Ironman™ Harness Detach Susp. Straps	Standard	EA	\$171.94
REL815100	Ironman™ Harness Detach Susp. Straps	Small	EA	\$171.94
REL815400	Ironman™ Harness Detach Susp. Straps	X-Large	EA	\$184.44
REL815500	Ironman™ Harness Detach Susp. Straps	XX-Large	EA	\$208.72
REL815600	Ironman™ Harness Detach Susp. Straps	Big-Boy	EA	\$228.65



## WEB INFORMATION

For a full listing and online ordering visit our website at: [www.gosafe.com](http://www.gosafe.com)





A

## A. Reliance® Ironman™ Harness 814000

- Ironman™ harness
- Vest style
- Integrated work belt
- Back & shoulder D-rings
- Universal fit
- Tongue buckle thigh straps
- Polyester webbing

SKU	Description	Size	UOM	Price
REL814000	Ironman™ Harness Retrieval	Standard	EA	\$140.13
REL814100	Ironman™ Harness Retrieval	Small	EA	\$127.22
REL814400	Ironman™ Harness Retrieval	X-Large	EA	\$156.28
REL814500	Ironman™ Harness Retrieval	XX-Large	EA	\$199.28
REL814600	Ironman™ Harness Retrieval	Big-Boy	EA	\$252.13

## B. Reliance® Ironman™ Harness 816000

- Ironman™ harness
- Vest style
- Integrated work belt
- Back, side positioning, front, & shoulder D-rings
- Universal fit
- Tongue buckle thigh straps
- Polyester webbing

SKU	Description	Size	UOM	Price
REL816000	Ironman™ Harness Climb/Pos./Retrieval	Standard	EA	\$230.77
REL816100	Ironman™ Harness Climb/Pos./Retrieval	Small	EA	\$227.06
REL816400	Ironman™ Harness Climb/Pos./Retrieval	X-Large	EA	\$267.12
REL816500	Ironman™ Harness Climb/Pos./Retrieval	XX-Large	EA	\$302.43
REL816600	Ironman™ Harness Climb/Pos./Retrieval	Big-Boy	EA	\$348.98



B



C

## C. Reliance® Ironman™ Harness 825000

- Ironman™ harness
- Vest style
- Integrated work belt
- Includes 'X' comfort pad
- Back, chest, & side positioning D-rings
- Detachable padded aluminium suspension seat
- Universal fit
- Tongue buckle thigh straps
- Polyester webbing

SKU	Description	Size	UOM	Price
REL825000	Ironman™ Harness w/ Belt and Seat	Standard	EA	\$304.59
REL825100	Ironman™ Harness w/ Belt and Seat	Small	EA	\$304.59
REL825400	Ironman™ Harness w/ Belt and Seat	X-Large	EA	\$323.65
REL825500	Ironman™ Harness w/ Belt and Seat	XX-Large	EA	\$362.88
REL825600	Ironman™ Harness w/ Belt and Seat	Big-Boy	EA	\$360.25

885000 Seat Included  
- may be purchased separately





\* Please Note : Harnesses sized as follows : 8XX1XX = Small, 8XX4XX = X-Large, 8XX5XX = XXL, 8XX6XX = Big Boy

Ironman™ Series Full Body Harnesses						
Part #	Style	D-Rings	Connectors	Material	Work Belt	Other
REL810000	Vest	Back	Tongue Buckle	Polyester	Yes	Universal Fit
REL811000	Vest	Back, Chest	Tongue Buckle	Polyester	Yes	Universal Fit
REL812000	Vest	Back, Side	Tongue Buckle	Polyester	Yes	Universal Fit
REL813000	Vest	Back, Chest, Side	Tongue Buckle	Polyester	Yes	Universal Fit
REL814000	Vest	Back, Shoulder	Tongue Buckle	Polyester	Yes	Universal Fit
REL815000	Vest	Back, Side	Tongue Buckle	Polyester	Yes	Integrated Suspension Seat
REL816000	Vest	Back, Side, Front, Shoulder	Tongue Buckle	Polyester	Yes	Universal Fit
REL822000	Vest	Back, Side	Tongue Buckle	Polyester	Yes	Aluminium Saddle Seat, 'X' Pad
REL825000	Vest	Back, Side, Chest	Tongue Buckle	Polyester	Yes	Detachable Saddle Seat, 'X' Pad

## How to Don a Harness

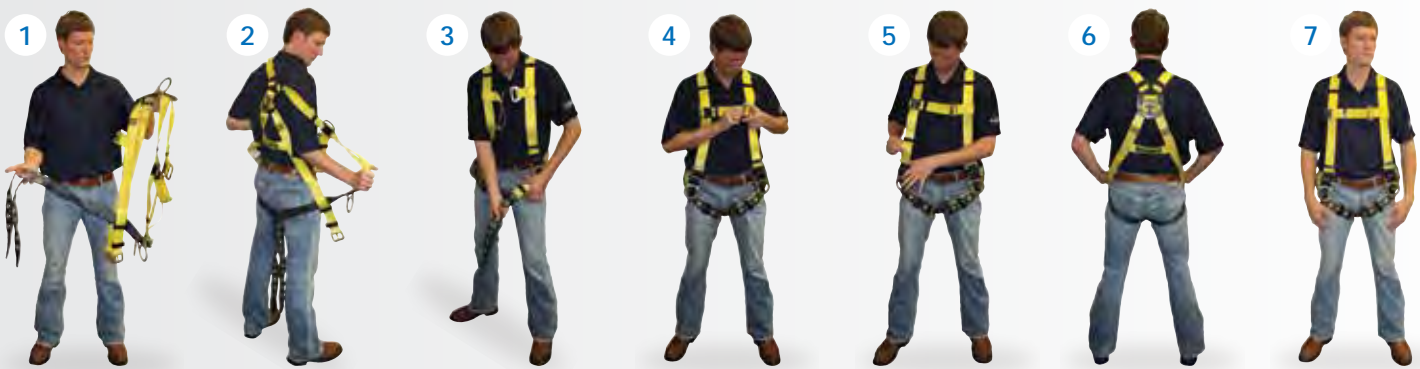

**1** Grasp harness by back D-ring and back plaque. Be certain straps are not twisted, and inspect for damage.

**2** Place harness over arms and on to shoulders. Shoulder straps should remain vertical on chest.

**3** Grasp leg straps and connect to buckles attached to straps on each hip. Insert excess strap through keepers. Leg straps should be snug.

**4** Attach chest strap by passing male buckle through female buckle. Strap should be at upper chest level. Retain excess strap with keeper.

**5** To tighten shoulders, pull up on free ends of straps. To loosen, push down on adjuster. Straps should be adjusted to the same length.

**6** Back D-ring should be centered between shoulder blades. To adjust, slide D-ring and plaque up or down along the webbing.

**7** A properly fitted harness should be snug, but not tight enough to prevent normal movement. ALWAYS properly adjust harness before use.

## Harness Icon Guide

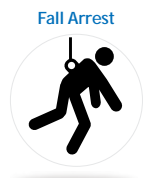

**Fall Arrest**  
Single dorsal (back) mounted D-Ring can be used in all fall arrest and fall (work) restraint scenarios. Personal Fall Arrest Systems (PFAS) should be configured to prevent free falls greater than 6' (1.8m). When PFAS cannot be configured to limit free fall's to 6' or less, equipment selection is critical and should be performed by a competent person. D-Ring should be centered between the user's shoulder blades.

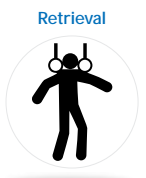

**Retrieval**  
For use in confined space rescue, insertion and extraction. Must be used in conjunction with a PFAS.



**Positioning**  
Positioning D-Rings can be used for work positioning and fall (work) restraint in some scenarios. Positioning systems must be rigged to prevent free fall's not to exceed 2' (.6m) and a PFAS must be used with work positioning systems.

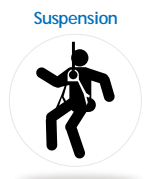

**Suspension**  
Designed to provide body support and permits leaning or sitting while working. Must be used in conjunction with a PFAS.



**Climbing**  
Frontal/Sternum: Climbing D-Ring (or other attachment element) may be used for ladder climbing fall arrest provided the connection between the harness and fall arrester does not exceed 9" (23cm). May be also used for fall arrest provided free fall is limited to 2' (.6m) or less and maximum arrest force does not exceed 900 lbs (4kN) Can also be used for rescue, controlled descent and work positioning in certain scenarios.



**Dielectric**  
Complies with ASTM F 887-04 Type A Full Body Harness. 40 cal/cm<sup>2</sup> ± 5 cal/cm<sup>2</sup> arc flash.







## Polyurethane Coated Full Body Harnesses & Shock Absorbing Lanyards

These products have been specifically designed for use in harsh work environments. With a .05" Polyurethane coating encapsulating the web, these products are easier to clean and more resilient to cuts and burns in harsh work environments than our standard, uncoated products.



REL800005



REL800055



REL802005

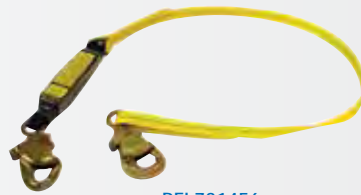

REL731456



REL741426



REL741256



\*REL761426

### Polyurethane Coated Harnesses

- .05" Polyurethane coating on webbing increases durability and eases cleaning
- Tattletale® webbing has an interior ply of contrasting bright red "strength" yarns that increase webbing strength to 7000 lbs (31kN) and instantly reveal cuts or abrasion
- Built-in impact load indicators
- Bar-coded individual serial numbers for traceability
- Indelible serial number in back plaque
- "Floating" thigh stitching reduces binding
- Improved geometry brings buckles to front of thigh
- Angled stitching for "tailored" sub-pelvic fit
- Extra large back pad eliminates dangerous 'D-ring droop'
- No elastic webbing
- Heat-set labels won't come off
- Corrosion resistant grommets
- Extra thick woven (not sewn) seat webbing for added durability

### Available Models - Harnesses

SKU	Description	UOM	Price
REL800005	Dorsal D-ring, Tongue Buckle legs	EA	\$119.51
REL800055	Dorsal D-ring, Pass-Thru legs	EA	\$119.51
REL802005	Dorsal & Positioning D-rings, Tongue Buckle legs	EA	\$104.08

### Polyurethane Lanyards

- .05" Polyurethane coating on webbing increases durability and eases cleaning
- Designed to withstand exposure to the harshest of work environments
- Limits arresting forces to less than 900 lbs (4kN) in a 6' (1.8m) free fall (\*761426 BigBoy™ limits forces to 1800 lbs (8kN) in same distance)
- Lanyard elongation will not exceed 42" (1.07m) in a 6' 1.8m) free fall arrest
- Clear Shrink tubing for shock pack and label inspec ability
- Serialized and barcoded for traceability
- All hooks comply with the stringent ANSI Z359.1-2007

### Available Models - Lanyards

SKU	Description	UOM	Price
REL741426	Dual leg, 1 Pelican, 2 Steelhead™ Tie-back hooks	EA	\$171.20
REL741256	Dual leg, 1 Pelican, 2 Rebar hooks	EA	\$184.66
REL761426	BigBoy™ Dual leg, 1 Pelican, 2 Steelhead™ Tie-back hooks	EA	\$162.78

\*Steelhead™ Tie-Back hooks can be used to tie the lanyard back on to itself when necessary. Only approved anchorage points may be used.



# 'Comfort Series' Full Body Harnesses



Based on the standard "A"™ Series and Ironman™ harnesses, the Comfort Series harnesses come with the 880082 "X" Comfort Pad and the 880092 Thigh Comfort Pads pre-installed. Pads are made from a durable nylon outer fabric, a soft, breathable foam center and a moisture wicking lining to provide all day comfort. Comfort Pads are designed to distribute the harness contact points over a larger surfaced area, and reduce fatigue throughout the day - even when used with heavy tool belts. Pads are removable, machine washable, and can be ordered separately and installed on most any harness.

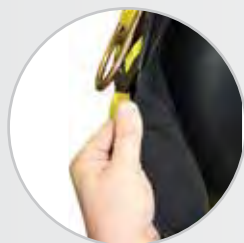

Moisture Wicking Lining

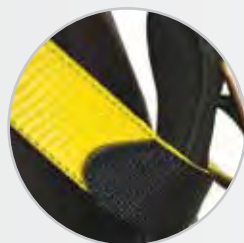

Washable Aearated Foam



Field Installable



'X' Padding Available Separately



Leg Padding Available Separately

## "A"™ Series



- "X" pad assists in harness donning by keeping shoulder straps separated and preventing entanglement
- Thigh pads provide comfort to the wearer in the event of extended after-fall suspension

## Ironman™ Series



### A. Reliance® Comfort Series - 'A' Series™ Models

SKU	Description	Size	UOM	Price
REL802015	Comfort Series - 'A' Series™ Models	Standard	EA	\$100.65
REL802115	Comfort Series - 'A' Series™ Models	Small	EA	\$100.65
REL802415	Comfort Series - 'A' Series™ Models	X-Large	EA	\$100.65
REL802515	Comfort Series - 'A' Series™ Models	XX-Large	EA	\$111.84
REL802615	Comfort Series - 'A' Series™ Models	Big-Boy	EA	\$147.87

### B. Reliance® Comfort Series - Ironman™ Models

SKU	Description	Size	UOM	Price
REL812015	Comfort Series - Ironman™ Models	Standard	EA	\$146.80
REL812115	Comfort Series - Ironman™ Models	Small	EA	\$146.80
REL812415	Comfort Series - Ironman™ Models	X-Large	EA	\$159.37
REL812515	Comfort Series - Ironman™ Models	XX-Large	EA	\$186.44
REL812615	Comfort Series - Ironman™ Models	Big-Boy	EA	\$209.80







Clean harness with lukewarm water and a mild laundry detergent solution. (no bleach solutions). Dry hardware with a clean, dry cloth, and hang to air dry. Do not machine launder. Do not attempt to disassemble the unit. A buildup of dirt, solvents, paint, etc. may prevent the harness from working properly, and in severe cases degrade the webbing to a point where it weakens and should be removed from service.

Store in a cool, dry, clean environment out of direct sunlight. Avoid contact with heat, oil, or harsh chemicals. Thoroughly inspect after extended storage. Store unusable product separately from usable product. If you have questions concerning the condition of your harness, or have any doubt about putting it into service contact RELIANCE.

### A. INSPECTION FREQUENCY

- 1) The harness must be inspected by the user prior to each use.
- 2) A competent person other than the user must inspect the harness thoroughly at least annually. Extreme working conditions (harsh environments that might degrade the webbing or corrode the hardware, prolonged use, etc.) may require increasing inspection frequency. Record the results of each formal inspection in the inspection and maintenance log as described below.

### B. INSPECTION PROCEDURE

- 1) Inspect all webbing (straps) and stitching for cuts, fraying, pulled or broken threads, abrasion, excessive wear, altered or missing straps, burns, and heat and chemical degradation. Broken stitches on the load indicator folds located below the back D-ring may be an indication that the harness has been impact loaded and must be removed from service. Observe the "Tattletale<sup>®</sup>" carrier ply webbing for surface areas with the brightly contrasting red colored yarns (or sometimes other brightly contrasting colors, depending the color of the outside web), indicating that excessive abrasion has occurred. For more details on the "Tattletale<sup>®</sup>" webbing as an inspection tool, contact RELIANCE.

- 2) Inspect all metallic hardware (i.e. D-rings, adjuster/buckles, tongue buckles and grommets) for deformation, fractures, cracks, corrosion, deep pitting, burrs, sharp edges, cuts, deep nicks, missing or loose parts, improper function, and evidence of excessive heat, chemical, or electrical exposures. Ensure buckles work & mate freely.

- 3) All labels should be present and fully legible. Record the inspection on the label area by punching a hole or marking. Harness instruction booklets contain an independent inspection log that should be maintained in conjunction with the inspection label on the harness to ensure that a) the inspections have been performed on a regularly scheduled basis and b) the inspection log will not become lost or misplaced. RELIANCE will be happy to provide additional forms or suggest other methods of electronically documenting this process.

- 4) Inspect all plastic parts (i.e. back D-ring locator, chest strap guide, strap collars, label) for cut, broken, excessively worn, missing and loose parts. (Labels are to be additionally checked in accordance with Step 3 above).

- 5) Verify each component or subsystem of the complete PFAS are inspected according with the associated manufacturer's instructions.

- 6) If inspection reveals a defective condition or improper maintenance remove unit from service immediately and destroy or label it as "UNUSABLE" until formal inspection by competent person. Defects, damage, excessive wear and/or aging are generally not repairable. Only RELIANCE or parties with written authorization from RELIANCE may make repairs to the harness.

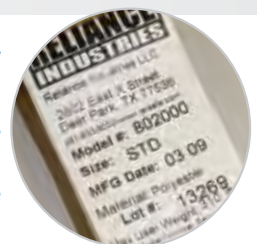
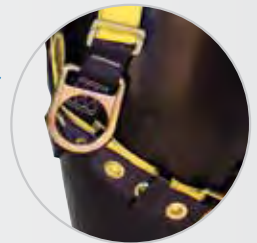

## A. Harness Carry Bag

Drawstring harness carry bag.

SKU	Description	UOM	Price
REL99901	Harness carry bag	EA	\$31.13



A

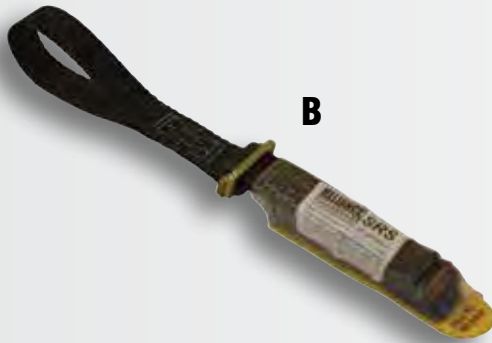

B

## B. Relief Stirrup

Suspension relief stirrup.

SKU	Description	UOM	Price
REL884000	Relief stirrup	EA	\$20.07

## C. D-Ring Extender

D-Ring extender with dielectric D-Ring.

SKU	Description	UOM	Price
REL880044	D-Ring Extender, dielectric D-ring	EA	\$68.99



C



D

## D. D-Ring Extender

D-Ring Extender with metal D-Ring.

SKU	Description	UOM	Price
REL880041	D-Ring extender, metal D-ring	EA	\$18.54



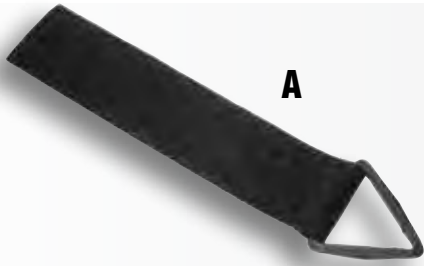

A

## A. Lanyard Retainer

Velcro lanyard retainer.

SKU	Description	UOM	Price
REL880010	Lanyard retainer	EA	\$7.04



B

## B. Harness Accessory Belt

Harness accessory belt.

SKU	Description	UOM	Price
REL880020	Harness accessory belt	EA	\$50.88



C

## C. Harness Accessory Belt with D-Rings

Harness accessory belt with back support padding and side positioning D-Rings.

SKU	Description	UOM	Price
REL882000	Harness accessory belt w/D-Rings	EA	\$70.53

## D. Harness 'X' Dorsal Comfort Padding

Harness 'X' dorsal comfort padding.

SKU	Description	UOM	Price
REL880082	Harness 'X' dorsal padding	EA	\$38.52



D

Hook & Loop Closures



E

## E. Harness Thigh Comfort Padding

Harness thigh comfort padding.

SKU	Description	UOM	Price
REL880092	Harness thigh padding	EA	\$10.02



## Reliance® Snaphooks

## Reliance® Carabiners

\*Snaphooks and carabiner with captive eye are not available for sale as single item.



**3014**

- 3/4" (19mm) gate opening
- 5,000 lb. (22kN) gate strength in all directions
- Can be used in tie-back applications



**3016**

- 3/4" (19mm) gate opening
- 3,600 lb. (16kN) gate strength in all directions
- Captive eye



**3006**

- 3/4" (19mm) gate opening
- 3,600 lb. (16kN) gate strength in all directions

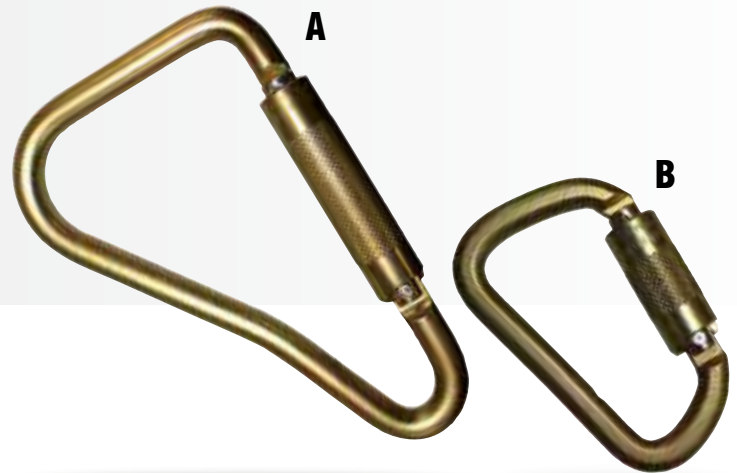

**3011**

- 2-1/4" (57mm) gate opening
- 3,600 lb. (16kN) gate strength in all directions

### A. Reliance® Carabiner 3064-36

- 2" (50mm) gate opening
- 3,600 lb. (16kN) gate strength in all directions
- Captive eye pin available on request

SKU	Description	UOM	Price
REL3064	Carabiner 2" (50mm)gate opening	EA	\$33.41

### B. Reliance® Carabiner 3062-36

- .8" (20mm) gate opening
- 3,600 lb. (16kN) gate strength in all directions
- Captive eye pin available on request

SKU	Description	UOM	Price
REL3062	Carabiner .8" (20mm)gate opening	EA	\$17.02





## “The industry standard in load-rated gates”

For over five years, Reliance has been leading the way in snaphook design, development, production, and implementation. We proudly design and manufacture our own snaphooks and carabiners, and have been exceeding the new ANSI requirements for a 3,600 lb. (16kN) gate for over five years. The SteelHead® Tie-Back snap hook set the standard, and the Pelican™ and Pelican™ II followed closely behind. All Reliance snaphooks are 100% proof-loaded to 3,600 lbs. and incorporate our patented FanGate™ design. FanGate design ensures proper axial loading and prevents webbing and hardware from being trapped behind the gate. The design prevents gate loading, and guards against potential rollout or burstout (accidental disengagement), and the dimensional design of the hook body makes false engagement impossible.

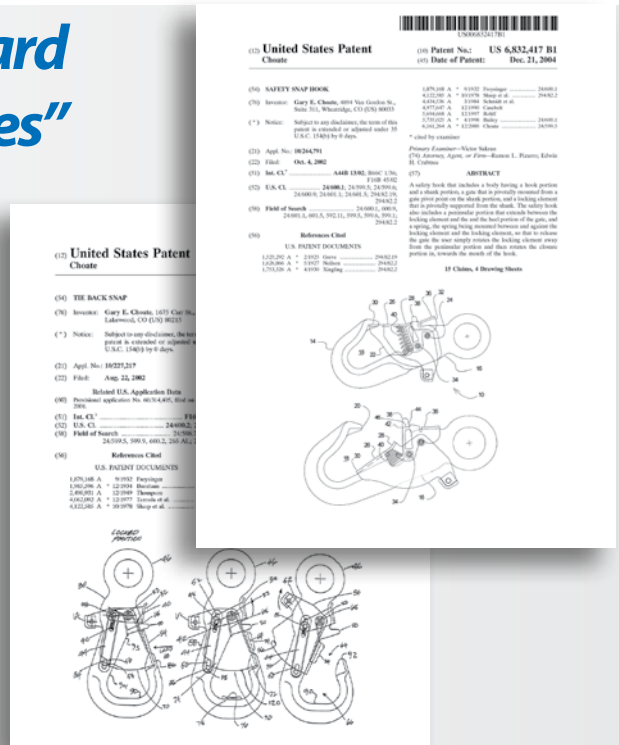

Reliance snaphooks are manufactured with patented design features

### Reliance® Snaphook Features



Alloy Steel Forged Bodies

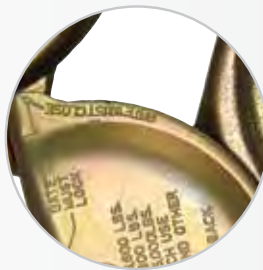

Patented FanGate™



Anti-Rollout Feature



Gate 'Wings' Protect Rivets

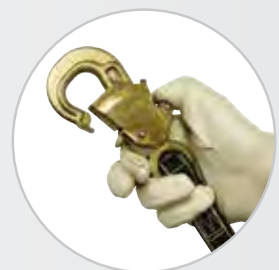

Ergonomically Friendly

### Requirements for ANSI Z359.1-2007 Snaphook Compliance

Under the previous Z359 standard, the gate strength load required 220 lbs. (.97kN) on the gate face, and 350 lbs. (1.5kN) on the gate side. Effective October 15, 2007, ANSI Z359.1-2007 required that all snaphook gates be capable of withstanding a gate side and face load of 3,600 lbs. (16kN) Ultimate strength of a snaphooks must be 5,000 lbs. (22kN) when loaded on the long axis of the hook.

All Reliance snaphooks meet the new standard. Some connection risks remain due to interference with the intended operation of the connector's gate or gate lock. Some known higher risk connections are listed below and should be avoided even when using the new ANSI hooks:

- Attaching more than one hook into a single connecting element is not recommended.
- Connecting combinations of hooks together is not recommended. This includes connecting two hooks together or one hook and one carabiner.
- Making connections where the hook lock can easily come into contact with another piece of equipment or structural member and potentially release the hook lock.



Our positioning devices are ideal for all types of work positioning and fall restraint applications, and effectively limit a worker's exposure to potential fall hazards. Each includes durable, easy-opening hardware and is designed to perform in the toughest of environments.

## A. Rebar Chain Assembly

- 14" (35.5cm) chain assembly
- 2 ea. 3/4" (19mm) Pelican™ snap hooks
- 1 ea. 2-1/4" (5.7cm) 3011 steel snap

SKU	Description	UOM	Price
REL726001	Rebar chain assembly	EA	\$87.58

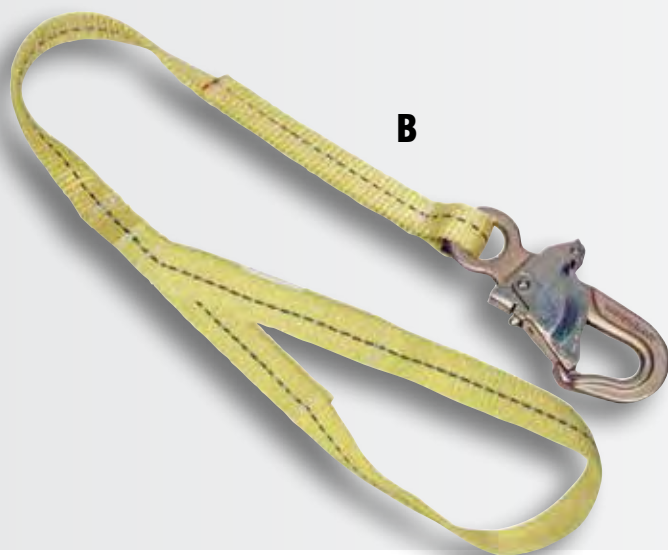

## B. Positioning Lanyard

- Tattletale®, 9,600 lb. (42.6kN) Tested, 1" (25mm) polyester web
- 1 ea. 3/4" (19mm) Pelican™ snap hooks on one end loop on the other

SKU	Description	UOM	Price
REL711954	Positioning lanyard	EA	\$37.56

## C. Adjustable Length Positioning Lanyard

- Tattletale®, 9,600 lb. (42.6kN) Tested, 1" (25mm) polyester web
- 2 ea. 3/4" (19mm) Pelican™ snap hooks
- Adjusts from 3.5' to maximum of 6' (1 - 1.8m)

SKU	Description	UOM	Price
REL717106	Positioning lanyard	EA	\$57.19

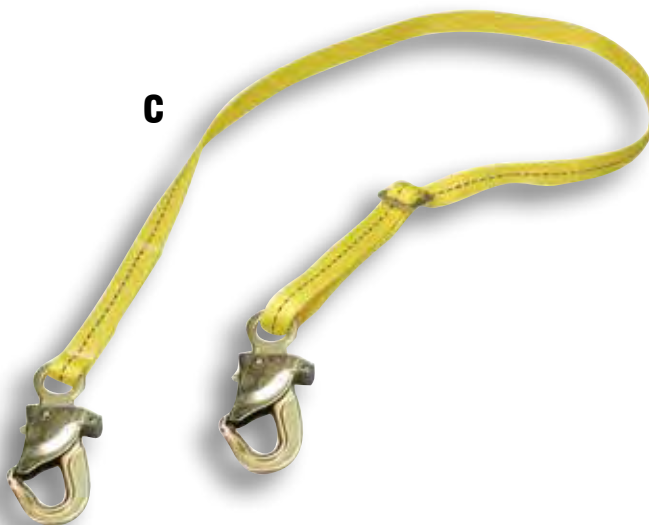





# Shock Absorbing Lanyards

Reliance offers a wide variety of shock absorbing lanyards; each designed to meet your specific fall protection requirements. Below are the five categories of lanyards available.

## Skyline™



The Skyline™ shock absorbing lanyard represents the industry standard in single-leg shock absorbers. They feature Reliance's patented "Tattletale®" webbing, making inspection quick and easy. Skyline™ lanyards are rigorously tested to comply with the most stringent ANSI standards, and are available with a variety of hooks for use in all types of environments.

The FatPack™ gets that name because it has two complete and independent shock absorber assemblies inside the same shock pack, making it fatter than a normal single shock pack. With two independent shock absorbers in the same shock pack the Reliance FatPack™ lanyards are able to absorb this "second" impact, reducing the possibility and severity of injury.

## FatPack™



## BlackMAX™



The BlackMAX™ shock-absorbing lanyard is the first of its kind. It "knows" how far the worker has fallen and can regulate the arresting force depending on the circumstances. It is designed to arrest falls in both "Force Level 1" (6' free-fall) and "Force Level 2" (12' free fall) (1.8 & 3.6m) conditions. This eliminates the need for 2 styles of shock-absorbing lanyards for employees that may be exposed to both potential fall conditions throughout the workday.

The BigBoy™ series of shock absorbing lanyards was designed for use by persons with a total body and tool weight greater than 310 lbs. (140kg) If deployed, the Maximum Arresting Force (MAF) will not exceed 1800 lbs. (8kN), and lanyard elongation will not exceed 42" (1.1m) - in adherence with existing requirements for equipment designed for users with a total body and tool weight of less than 310 lbs.

## BigBoy™



## QuickStop™



The QuickStop™ series of shock absorbing lanyards is "Tuned" to greatly reduce deceleration distance in the event of a fall. These lanyards are designed for use in areas where clearance to the next lower level is less than 14' (4.2m). Maximum Arresting Force (MAF) will not exceed 1800 lbs (8kN).



The Skyline™ shock absorbing lanyard represents the industry standard in single-leg shock absorbers. They feature Reliance's patented "Tattletale®" webbing, making inspection quick and easy. Skyline™ lanyards are rigorously tested to comply with the most stringent ANSI standards, and are available with a variety of hooks for use in all types of environments.

## A. Reliance® Skyline™ Shock Absorbing Lanyard

SKU	Description	UOM	Price
REL732101	Skyline™ shock absorber w/ 1 ea 3/4" snaphook, 1 ea screwlock connector	EA	\$41.85



## B. Reliance® Skyline™ Shock Absorbing Lanyard

SKU	Description	UOM	Price
REL731406	Lanyard, Skyline™ shock absorber w/ 1 ea 3/4" snap, 1 ea tieback 3/4" snap	EA	\$86.53

## C. Reliance® Skyline™ Shock Absorbing Lanyard

SKU	Description	UOM	Price
REL731126	Lanyard, Skyline™ shock absorber w/ 2 ea 3/4" snaps and tieback D-Ring	EA	\$91.52





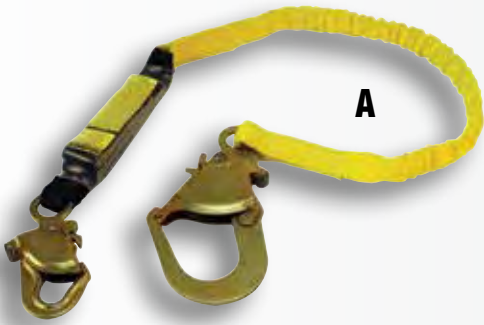

A

## A. Reliance® Elastic Web Skyline™ Shock Absorbing Lanyard

SKU	Description	UOM	Price
REL735206	Lanyard, Skyline™ shock absorber w/ 1 ea 3/4" snap, 1 ea 2-1/4" rebar snap	EA	\$127.16

## B. Reliance® Adjustable Lanyard Skyline™ Shock Absorbing Lanyard

SKU	Description	UOM	Price
REL737106	Lanyard, Skyline™ shock absorber w/ 2 ea 3/4" snaps	EA	\$71.17



B



C

## C. Reliance® Adjustable Lanyard Skyline™ Shock Absorbing Lanyard

SKU	Description	UOM	Price
REL737406	Lanyard, Skyline shock absorber w/ 1 ea 3/4" snaps, 1 ea tieback snap	EA	\$91.81

## D. Reliance® Adjustable Lanyard Skyline™ Shock Absorbing Lanyard

SKU	Description	UOM	Price
REL737206	Lanyard, Skyline™ shock absorber w/ 1 ea 3/4" snap, 1 ea 2-1/4" rebar snap	EA	\$116.96



D

## Skyline™ Shock Absorbing Lanyards

Model	Description	Length	Legs	S/A <sup>a</sup>	Leg Matl <sup>b</sup>	Leg-Ends <sup>c</sup>	Ad-just	Usage <sup>d</sup>
731126	S/A 1" web, 2 ea. 3/4" snaps, Tieback D-Ring	6	1	S1	1" PE	3/4"		F,A
731406	S/A 1" web, 1 ea. 3/4" , 1 ea. Tieback 3/4" snap	6	1	S1	1" PE	3/4"		F,A
732101	S/A only, 1 ea. 3/4" snap, 1 ea. screwlock connector	N/A	1	S1	N/A	3/4"		F
735206	1" elastic web, 1 ea. 3/4" snap, 1 ea. 2-1/4" Rebar snap	6	1	S1	Elastic	3/4", 2-1/4"		F
737106	S/A 1" web, adjust., 2 ea. 3/4" snaps	6	1	S1	1" PE	3/4"	X	F,A
737206	S/A 1" web, adjust., 1 ea. 3/4" snaps, 1 ea. 2-1/4" Rebar snap	6	1	S1	1" PE	3/4", 2-1/4"		F
737406	S/A 1" web, adjust., 1 ea. 3/4" & 1 ea. Tieback 3/4" snap	6	1	S1	1" PE	3/4"	X	F,A

a - S1 = single shock pack

b - 1" (25mm) PE = polyester web; Cable = 1/4" (6mm) vinyl coated galvanized; 1-3/4" = 1-3/4" (45mm) polyester web

c - Leg-End Hooks: 3/4" (19mm) = Pelican™; 2-1/4" (57mm) = 2-1/4" opening rebar hook; O-ring = 2" or 3" (50 or 76mm) forged O-ring; 3/4" (19mm) TB = SteelHead® Tieback Hook

d - Usage: P = Positioning, R = Restraint, A = Anchorage, F= Fall Arrest, 100 = Y-lanyard for 100 percent tie-off



Reliance twin-leg lanyards use a FatPack™ shock absorber. The FatPack™ gets that name because it has two complete and independent shock absorber assemblies inside the same shock pack, making it fatter than a normal single shock pack. Most manufacturers make twin lanyards with both legs attached to just one shock absorber, so isn't that "good enough"? Why do Reliance twin lanyards have two independent shock absorbers?

The answer is that Reliance designs products for worker safety, not just to meet the minimum required by the OSHA or ANSI standards. As an example with three D-ring harnesses and twin-legged lanyards it's common to see workers use one of the harness hip D-rings as a lanyard keeper, while the other lanyard leg is connected to an anchorage. Even though this is common it's not a safe practice. In a fall event the leg of the lanyard that is connected to the anchorage will extend up to 42" (1.1m) as the webbing absorbs the impact.

If both lanyard legs are connected to just one shock pack the leg that is extending will pull the other lanyard leg with it. If that other leg of the lanyard is connected to the worker at the harness hip D-ring, that hip will be jerked instantly upward toward the anchorage point by the extending shock absorber. With two independent shock absorbers in the same shock pack the Reliance FatPack™ lanyards are able to absorb this "second" impact, reducing the possibility and severity of injury. This is not something currently required by OSHA or ANSI standards, it is something done by Reliance because we feel it should be.

While this kind of issue can be addressed through worker training, the Reliance philosophy is that it's best to address equipment issues through product design whenever possible. The less a worker needs to think about how to use his equipment correctly the more likely it is he will actually use it safely.

## A. Reliance® Lanyard with FatPack™ Shock Absorber

SKU	Description	UOM	Price
REL741206	Lanyard, FatPack™ shock absorber w/ 1 ea 3/4" snap, 2 ea 2-1/4" rebar snaps	EA	\$157.85

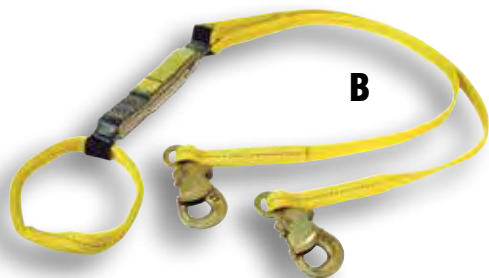

## B. Reliance® Lanyard with FatPack™ Shock Absorber

SKU	Description	UOM	Price
REL741646	Lanyard, FatPack™ shock absorber w/ web loop, 2 ea 3/4" tieback snaps	EA	\$107.42





**A**

### A. Reliance® Skyline™ Lanyard with Twin Tie-back Steelhead™ Hooks

SKU	Description	UOM	Price
REL741406	Lanyard, Skyline™ with FatPack™, Twin Tie-back Steelhead™ Hooks	EA	\$123.99

### B. Reliance® 3/8" Cable Lanyard with FatPack™ Shock Absorber

SKU	Description	UOM	Price
REL744206	Lanyard, FatPack™ shock absorber w/ 1 ea 3/4" snap, 2 ea 2-1/4" rebar snaps	EA	\$184.89



**B**

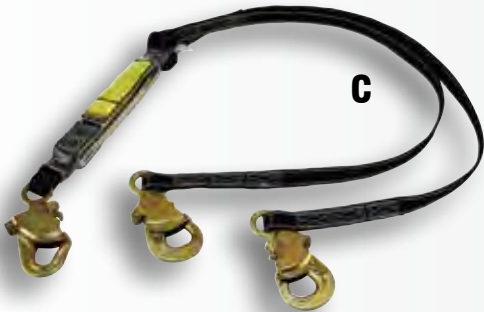

**C**

### C. Reliance® Kevlar Web Lanyard with FatPack™ Shock Absorber

SKU	Description	UOM	Price
REL749406	Lanyard, FatPack™ shock absorber w/ 1 ea 3/4" snap, 2 ea 3/4" tieback snaps	EA	\$206.81

FatPack™ Shock Absorbing Lanyards								
Model	Description	Length	Legs	S/A <sup>a</sup>	Leg Matl <sup>b</sup>	Leg-Ends <sup>c</sup>	Adjust	Usage <sup>d</sup>
741206	S/A twin 1" web, 1 ea. 3/4" & 2 ea. 2-1/4" Rebar snaps	6	2	S2	1" PE	3/4", 2-1/4"		F,100
741646	S/A twin 1" web, web loop, 2 ea. Tieback 3/4" snaps	6	2	S2	1" PE	loop, 3/4"		F,100,A
743406	S/A twin 1/2" kernmantle rope, 1 ea. 3/4", 2 ea. Tieback 3/4" snaps	6	2	S2	1/2" rope	3/4"		F,100,A
744206	S/A twin 3/8" cable, 1 ea. 3/4" & 2 ea. 2-1/4" Rebar snaps	6	2	S2	1/4" cable	3/4", 2-1/4"		F,100
749406	S/A twin 1" Kevlar web, 1 ea. 3/4" & 2 ea. Tieback 3/4" snaps	6	2	S2	11" Kevlar	3/4"		F,100,A

S2 = double FatPack™ shock pack

b - 1" (25mm) PE = polyester web; Cable = 1/4" (6mm) vinyl coated galvanized;

1-3/4" = 1-3/4" (45mm) polyester web

c - Leg-End Hooks: 3/4" (19mm) = Pelican™; 2-1/4" (57mm) = 2-1/4" opening rebar hook; O-ring = 2" or 3" (50 or 76mm) forged O-ring; 3/4" (19mm) TB = SteelHead® Tieback Hook

d - Usage: P = Positioning, R = Restraint, A = Anchorage, F= Fall Arrest, 100 = Y-lanyard for 100 percent tie-off





The BlackMAX™ shock-absorbing lanyard is the first of its kind. It has the capability to determine how far a worker has fallen and can regulate the arresting force depending on the circumstances, a first in the industry. This is a unique feature to the lanyard and what makes it “smart.”

The BlackMAX™ shock-absorbing lanyard is designed to arrest falls in both “Force level 1” and “Force level 2” conditions. This eliminates the need for 2 styles of shock-absorbing lanyards for employees that may be exposed to both potential fall conditions throughout the workday.

If a worker has fallen 6’ (1.8m) or less, the lanyard arrests the energy at 900 lbs. (4kN). However, if a worker has fallen at a height greater than 6’, the lanyard will arrest the energy at 1,800 lbs. (8kN). In both cases, the lanyard does not allow the extension to exceed 42” (1.1m).

Another feature of the BlackMAX™ lanyard is that it comes standard with a 5,000 lb. (22.2kN) Gateload snaphook. With Gateload snaphooks, workers are able to tie back to the lanyard around a structure and still stay within regulation, connect at feet level with the added security of the 5,000 lb. gate to prevent gate loading disconnection.

## A. Reliance® BlackMAX™ Shock-Absorbing Lanyard

SKU	Description	UOM	Price
REL731700	Lanyard, BlackMAX™ shock-absorbing lanyard, 1 ea 3/4” snap, 1 ea 3/4” tieback	EA	\$112.72



## B. Reliance® BlackMAX™ Shock-Absorbing Lanyard

SKU	Description	UOM	Price
REL741700	Lanyard, BlackMAX™ shock-absorbing lanyard, 1 ea 3/4” snap, 2 ea 3/4” tieback	EA	\$174.15





# Shock Absorbing Lanyards - BigBoy™

The BigBoy™ series of shock absorbing lanyards was designed for use by persons with a total body and tool weight greater than 310 lbs. (140kg). If deployed, the Maximum Arresting Force (MAF) will not exceed 1800 lbs. (8kN), and lanyard elongation will not exceed 42" (1.1m) - in adherence with existing requirements for equipment designed for users with a total body and tool weight of less than 310 lbs.



**A**

## A. Reliance® BigBoy™ Series Shock-Absorbing Lanyard

SKU	Description	UOM	Price
REL751106	Lanyard, BigBoy™ series w/ 2 ea 3/4" snaps	EA	\$91.63

## B. Reliance® BigBoy™ Series Shock-Absorbing Lanyard

SKU	Description	UOM	Price
REL751206	Lanyard, BigBoy™ series w/ 1 ea 3/4" snap, 1 ea 2-1/4" snap	EA	\$111.55

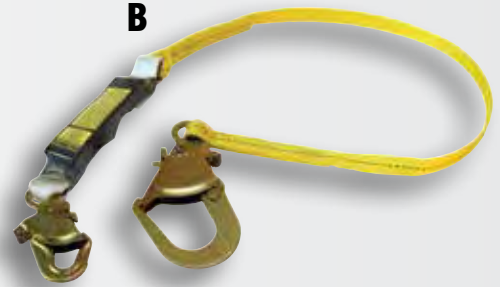

**B**



**C**

## C. Reliance® BigBoy™ Series Shock-Absorbing Lanyard

SKU	Description	UOM	Price
REL767206	Lanyard, BigBoy™ series w/ 1 ea 3/4" snap, 2 ea 2-1/4" snaps	EA	\$199.31

## D. Reliance® BigBoy™ Series Shock-Absorbing Lanyard

SKU	Description	UOM	Price
REL761106	Lanyard, BigBoy™ series w/ 3 ea 3/4" snaps	EA	\$130.15



**D**



## A. Reliance® BigBoy™ Series Shock-Absorbing Lanyard

SKU	Description	UOM	Price
REL761206	Lanyard, BigBoy™ series w/ 1 ea 3/4" snaps, 2 ea 2-1/4" rebar snaps	EA	\$176.13

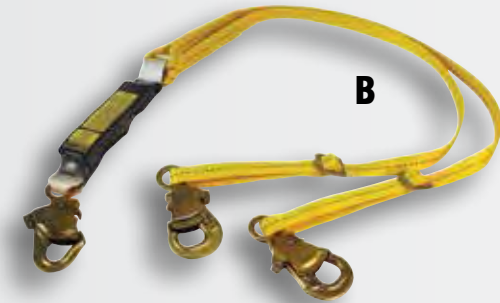

## B. Reliance® BigBoy™ Series Shock-Absorbing Lanyard

SKU	Description	UOM	Price
REL767406	Lanyard, BigBoy™ series w/ 1 ea 3/4" snaps, 2 ea 3/4" tieback snaps	EA	\$171.37

**“Proven Performance  
for Larger Users”**

\*Due to design limitations, BigBoy™ and BlackMax™ products do not utilize FatPack™ technology

BigBoy™ Shock Absorbing Lanyards									
Model #	Description	Size (ft.)	Legs	S/A <sup>a</sup>	Leg Matl <sup>b</sup>	Leg-Ends <sup>c</sup>	Adjust	Usage <sup>d</sup>	
751106	BigBoy™ 440 lb S/A, 1" web, 2 ea. 3/4" snaps	6	1	S1	1" PE	3/4"	No	F	
761106	BigBoy™ twin 440 lb S/A, 1" web, 3 ea. 3/4" snaps	6	2	S1	1" PE	3/4"	No	F	
751206	BigBoy™ single 440 lb S/A, 1" web, 1 ea. 3/4", 1 ea. 2-1/4" snap	6	2	S1	1" PE	3/4"	No	F,100	
761206	BigBoy™ twin 440 lb S/A, 1" web, 1 ea. 3/4", 2 ea. 2-1/4" snaps	6	2	S1	1" PE	3/4"	No	F,100	
767206	BigBoy™ twin 440 lb S/A, 1" web, 1 ea. 3/4", 2 ea. 2-1/4" snaps	6	2	S1	1" PE	3/4"	Yes	F,100	
767406	BigBoy™ twin 440 lb S/A, 1" web, 1 ea. 3/4", 2 ea. 3/4" TB snaps	6	2	S1	1" PE	3/4"	Yes	F,100	

a - S1 = single shock pack, S2 = double FatPack™ shock pack  
 b - 1" (25mm) PE = polyester web; Cable = 1/4" (6mm) vinyl coated galvanized;  
 1-3/4" = 1-3/4" (45mm) polyester web

c - Leg-End Hooks: 3/4" (19mm) = Pelican™; 2-1/4" (57mm) = 2-1/4" opening rebar hook; O-ring = 2" or 3" (50 or 76mm) forged O-ring; 3/4" (19mm) TB = SteelHead® Tieback Hook  
 d - Usage: P = Positioning, R = Restraint, A = Anchorage, F= Fall Arrest, 100 = Y-lanyard for 100 percent tie-off







Under OSHA standards (1926.502(d)(6)) snap hooks shall not be engaged to a D-ring to which another snaphook or other connector is attached unless the snaphook is a locking type and designed for the connection. While the Steelhead® snap has two opposing independent locking & unlocking mechanisms and is rated 5000 lbs. (22,.2kN) based on ANSI format tests, it is deemed compatible to engage two Steelhead® snaphooks to a D-ring with special training considerations. A co-worker should attach the snaphooks to the D-ring to prevent interlocking of the snaps - this decreases the risk of false engagement. The snaphooks should be free to rotate in the D-ring and the right bearing snaphook lanyard should be used on the right and the left bearing snaphook lanyard should be used on the left side.

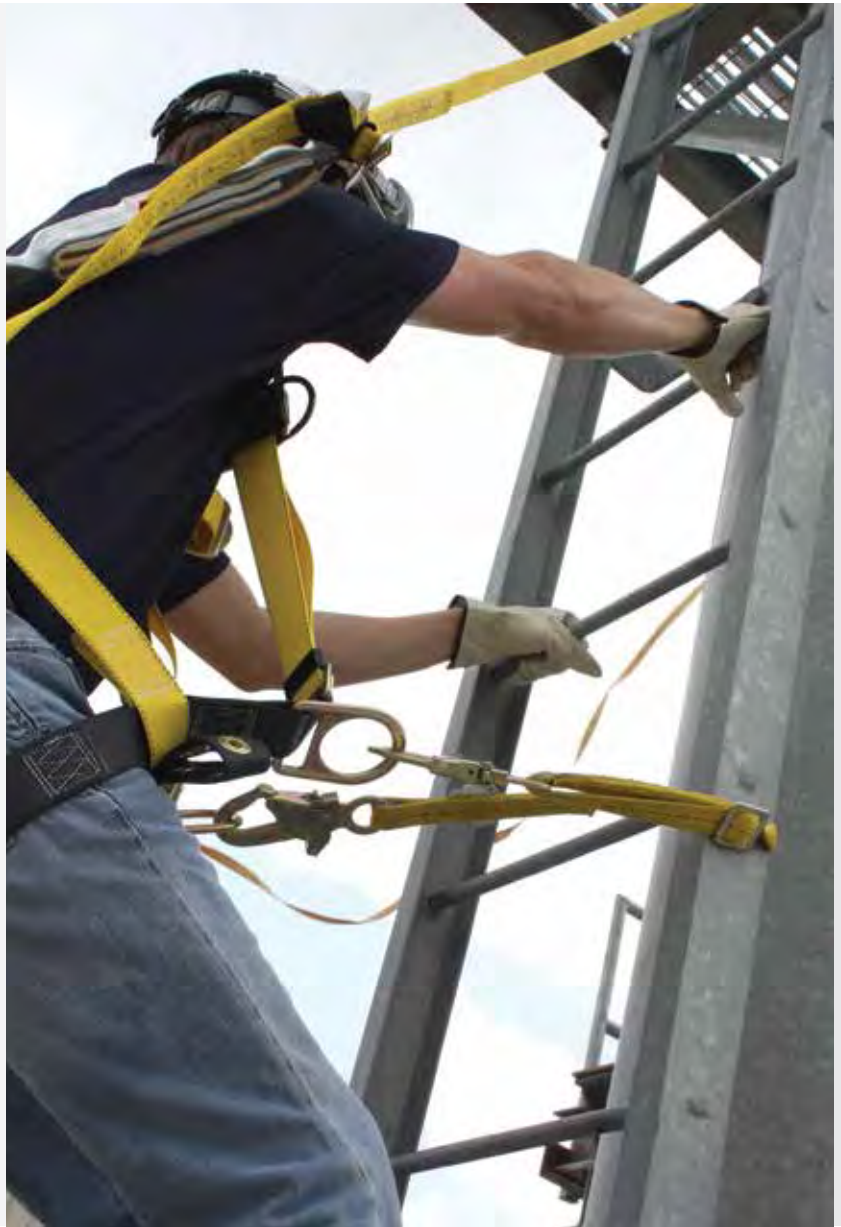

## “Versatile Solutions for Jobsite Challenges”



A

### A. Reliance® QuickStop™ SA Lanyard with Steelhead®

The 731622 QuickStop™ 2.5' (.76Mm) SA Lanyard with Steelhead® for attaching to the back D-ring and Steel Rebar snap assembly for anchorage connection.

SKU	Description	UOM	Price
REL731622	Lanyard QuickStop™ 2.5 ft, w/ 1 ea Steelhead®, 1 ea 2-1/4" rebar snap	EA	\$116.84

### B. Reliance® QuickStop™ SA Lanyard with Steelhead®

The 731623 QuickStop™ 3ft (.9m) SA Lanyard with Steelhead® for attaching to the back D-ring and Steel Rebar snap assembly for anchorage connection.

SKU	Description	UOM	Price
REL731623	Lanyard QuickStop™ 3 ft, w/ 1 ea Steelhead®, 1 ea 2-1/4" rebar snap	EA	\$116.84



B



REL4015

REL4020

Self retracting lanyards are among the best options for both fall arrestor and deceleration devices. Skyloc™ self retracting lanyards are designed to arrest a fall in 2' (.6m) or less and limit the maximum arresting force (MAF) to 900 lbs (4 kN). Deceleration distance will not exceed 42" (1.1m). With short fall arrest distances and lower MAF's the Skyloc™ is the best option where fall clearance is a concern.

- Lightweight thermoplastic case
- Two fast and positive cam-driven locking pawls.
- Available with cable or polyester web
- Forged steel Pelican hook

Available Models						
SKU	Length	Weight	Case	Line	Hook	Price
REL4015	18' (5.4m)	7.5 (3.4 kg)	Thermoplastic	3/16" (4.5mm) Galvanized Cable	3006	\$428.31
REL4020	20' (6.1m)	6.8 (3 kg)	Thermoplastic	1" (25mm) Polyester Web	3006	\$325.46
REL4030	30' (9.1m)	25 lbs (11.3 kg)	Steel	3/16" (4.5mm) Galvanized Cable	3006	\$733.34
REL4050	50' (15.2m)	26.8 lbs (12.1 kg)	Steel	3/16" (4.5mm) Galvanized Cable	3007	\$756.44
REL4100	100' (30.4m)	43.5 lbs (19.7 kg)	Steel	3/16" (4.5mm) Galvanized Cable	3007	\$1211.92



REL4100

REL4030  
REL4050

Loaded Snaphook - If red band is visible, remove from service

- Heavy-duty zinc plated full steel case
- Three fast and positive cam-driven locking pawls.
- Brass and stainless-steel brake for long life and consistent operation
- Available with galvanized or stainless aircraft cable
- Forged steel Pelican hook with load indicating swivel prevents false engagement

**"Skyloc™ SRL's -  
Proven Performance,  
Built to Last"**





## StopLite® Personal Fall Arrest Device

The StopLite® Personal Fall Arrest Device from Reliance Fall Protection offers the safety and reliability of a standard Self-Retracting Lifeline in a compact, durable package. Available in multiple configurations, the StopLite® has been tested to the highest standards and complies with applicable OSHA standards and ANSI Z359.1-2007.

REL4004



REL4005



REL4004T



REL4005T



REL4003T



### Available Models

Part #	Length	Hook Type	Hook No.	Price
REL4004	7' (2.1m)	Pelican	3006	\$217.05
REL4004T	7' (2.1m)	Pelican	3006	\$406.76
REL4005	7' (2.1m)	Rebar	3011	\$232.56
REL4005T	7' (2.1m)	Rebar	3011	\$438.33
REL4003	10' (2.1m)	Tie-Back	3014	\$215.97
REL4003T	10' (2.1m)	Tie-Back	3014	\$519.00

## The SkyLoc II Series SRL from Reliance. Redesigned - inside AND out.



The SkyLoc name has always been synonymous with durable, reliable performance. The new SkyLoc II Series is built on that reputation, but we've added features that make this series safer, and easier to use than ever before.

Reliance's new lightweight, fiberglass reinforced, stackable nylon housings include things like a big carry handle opposite a flat surface, making the units easier to transport and store. A swivel connection on top combined with a swivelling snap hook means no twisting on your anchorage. And a rubberized, form-fitted cable grip makes feeding out cable a snap. That's not all - additional features include :

- *Fiberglass reinforced nylon housing*
- *Load-bearing steel frame*
- *Over-sized steel anchor swivel*
- *Patented, non-centrifugal Fail-Safe locking mechanism*
- *Lightweight and incredibly rugged*
- *Exceeds the Class A requirements of ANSI Z359.14*
- *Exceeds the requirements of OSHA 1910 and 1926.*

### Available Models

Part #	Working Length (Ft)	Cable Type	Housing Material	Connector	Price
REL4000020	20	Galvanized	Fiberglass Reinforced Nylon	3008 Double Locking w/ Swivel	\$357.32
REL4000030	30	Galvanized	Fiberglass Reinforced Nylon	3008 Double Locking w/ Swivel	\$382.76
REL4000050	50	Galvanized	Fiberglass Reinforced Nylon	3008 Double Locking w/ Swivel	\$625.78
REL4000100	100	Galvanized	Fiberglass Reinforced Nylon	3008 Double Locking w/ Swivel	\$1100.00





## “Skyloc™ SRL’s - Proven Performance, Built to Last”

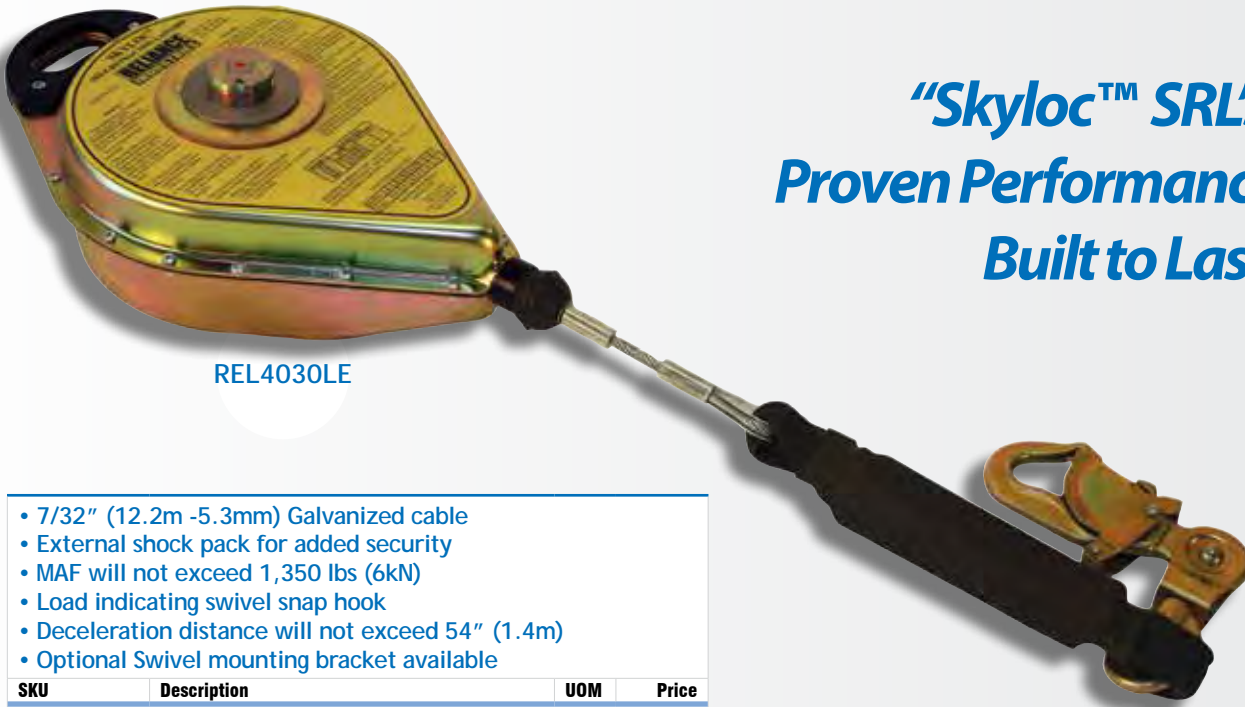

REL4030LE

- 7/32" (12.2m -5.3mm) Galvanized cable
- External shock pack for added security
- MAF will not exceed 1,350 lbs (6kN)
- Load indicating swivel snap hook
- Deceleration distance will not exceed 54" (1.4m)
- Optional Swivel mounting bracket available

SKU	Description	UOM	Price
REL4030LE	Skyloc™ SRL 30' galvanized cable	EA	\$777.66

## “Diverse SRL’s Designed to Perform in the World’s Toughest Environments”



REL4350

The 4350 is designed specifically for leading edge work. It can be used as a standard self retracting lifeline, but features a lock-off control that turns the SRL into an adjustable length restraint device.

- 40' of 7/32" (12.2m - 5.3mm) Galvanized cable
- External shock pack for added security
- MAF will not exceed 1,350 lbs (6kN)
- Load indicating swivel snap hook
- Deceleration distance will not exceed 54" (1.4m)
- Optional Swivel mounting bracket available

SKU	Description	UOM	Price
REL4350	SRL with adjustable length restraint device	EA	\$921.91

### A. Rope Grab

Automatic fall-arrestors locks itself immediately on the vertical lifeline in the event of a fall. "Hands Free" operation on weighted vertical safety line. Moves freely along 5/8" (16mm) rope on brass rollers.

SKU	Description	UOM	Price
REL5000	Rope grab	EA	\$47.19
REL5001	Rope grab	EA	\$136.92



REL5001



Easily accommodates snaphook connection

A

REL5000



5000 & 5001 with attached 732101 shock absorbing lanyards

### B. 5010-XXX Series of Vertical Lifelines

The 5010-XXX Series of Vertical lifelines are made from a combination fiber rope with a firm lay, excellent wear and a high strength to weight ratio. Produced with high strength continuous filament polyester surface yarns wrapped over high tenacity Ultra Blue™ Fiber. Comes with 1 spliced eye with a thimble and 3062-36 carabiner.

SKU	Description	EA	Price
REL5010-25	Vertical lifeline 25' w/ carabiner	EA	\$92.60
REL5010-50	Vertical lifeline 50' w/ carabiner	EA	\$145.63
REL5010-100	Vertical lifeline 100' w/ carabiner	EA	\$201.55
REL5010-150	Vertical lifeline 150' w/ carabiner	EA	\$269.73
REL5010-200	Vertical lifeline 200' w/ carabiner	EA	\$338.92
REL5010-250	Vertical lifeline 250' w/ carabiner	EA	\$403.24
REL5010-300	Vertical lifeline 300' w/ carabiner	EA	\$467.60
REL5010	Vertical lifeline 600' w/ carabiner	EA	\$520.33



REL5010 Series

B

Vertical Lifeline Fall Arrestor's should only be used with shock absorbing lanyards 3' (.9m) in length or less. Lanyards greater than 3' may produce free falls greater than 6' (1.8m) and produce a MAF greater than 1,800 lbs. (8kN) We recommend a Reliance 731103 shock absorbing lanyard.





## A. Vertical Ladder Stanchion

The 6512 Vertical Ladder Stanchion is designed to anchor a Self Retracting Lifeline that a single worker can use to climb or descend a fixed metal ladder. The Ladder Stanchion uses adjustable rung clamps to attach to any OSHA standard ladder. Once installed, an SRL with a Maximum Arrest Force of 900 lbs may be attached to the head assembly of the Stanchion providing fall protection for a single individual (the Stanchion is designed to be used by one individual at a time only).

- Ladder Stanchion Tube, Rung Clamps, Bolts, washers and nuts : Zn plated steel
- Height : 6' (1.8m) - Weight : 40 lbs (18kg)
- Accommodates any size SRL
- Durable Zinc plated steel construction
- Attaches to any OSHA compliant fixed metal ladder

SKU	Description	UOM	Price
REL6512	Vertical Ladder Stanchion	EA	\$342.40

## Adjustable Width Beam Anchors

Adjustable Width Beam Anchors are temporary (movable) anchorages designed for use in steel erection. The steel bar, aluminium jawed HLL anchor clamp can be used to anchor a Horizontal Lifeline System, or as an anchor point for a personal fall arrest system.

## B. Reliance® Adjustable Width Beam Anchor 3093

- Temporary (Movable) Anchorage
- 14,500 lbs. Maximum Breaking Strength
- Attaches to I-Beams with 4" to 16-5/8" flanges and 1/4" to 1-3/4" flange thickness (4 - 41.5cm width, .6 - 4.4cm thick)

SKU	Description	UOM	Price
REL3093	Adjustable width beam anchor	EA	\$384.27

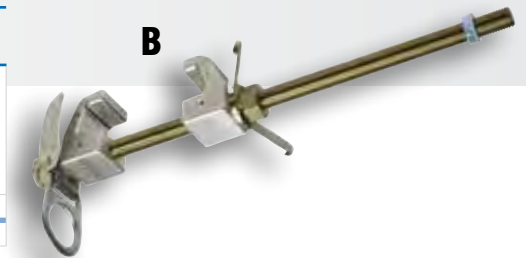

C

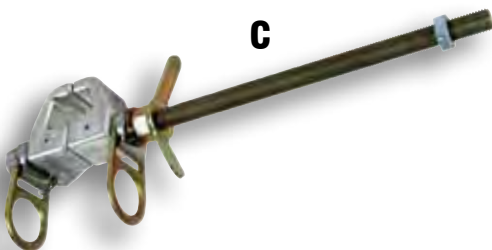

## C. Reliance® Adjustable Width Beam Anchor 3098

- Dual anchor ring for personal fall arrest equipment or engineered Horizontal Lifeline

SKU	Description	UOM	Price
REL3098	Adjustable width beam anchor, dual anchor ring	EA	\$397.42

## Adjustable Width Sliding Beam Anchors

These anchors combine freedom of movement and dependable fall protection. When attached to a beam, the anchor trails behind the user through attachment of a shock absorbing lanyard. Anchors are simple to install, remove, and size, with no pins or chains. Dual beam grip adjustment prevents twisting and turning as it moves along the beam, and synthetic wear pads are replaceable.

*Easy Adjustment*



### A. Reliance® Adjustable Width Sliding Beam Anchor 3096

- Fits flange 3-3/4" to 12-1/2" wide and 1/4" up to 1-1/4" thick (9.5cm to 32cm wide, 6 - 32mm thick)

SKU	Description	UOM	Price
REL3096	Adjustable width sliding beam anchor 3-3/4" to 12-1/2" wide	EA	\$357.16

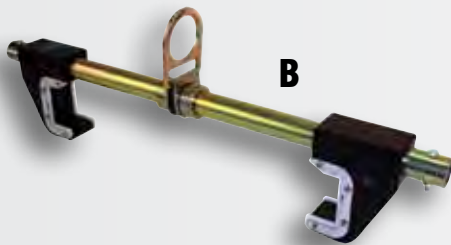

### B. Reliance® Adjustable Width Sliding Beam Anchor 3097

- Fits flange 5-1/2" to 18" wide and 1/4" up to 2-1/2" thick (14 - 46cm wide, 6mm - 60mm thick)

SKU	Description	UOM	Price
REL3097	Adjustable width sliding beam anchor 5-1/2" to 18" wide	EA	\$403.78

### C. Reliance® Adjustable Width Sliding Beam Anchor 3104

- Fits flanges 5-1/2" to 26" wide and 1/2" to 3" thick. (14 - 66cm wide, 13-76mm thick)

SKU	Description	UOM	Price
REL3104	Adjustable width sliding beam anchor 5-1/2" to 26" wide	EA	\$867.16



### D. Reliance® Easy Slider Beam Anchor

- Light-weight, easy to install and remove and allows for safe, dependable tie-off without restricting mobility.
- Easy Slider is ideal for use on smaller I-beam profiles.
- Durable construction and simple operation put this product in a class by itself.

SKU	Description	UOM	Price
REL3105-1	Easy Slider Beam Anchor	EA	\$214.88

*Anchors may be used over head or at foot level when used with the BlackMax™ shock absorber*





## Adjustable Width Beam Anchors

### A. Reliance® Adjustable Width Beam Anchor 3092

- Attaches to I-beams 4" to 16-5/8" wide with a 1/4" to 1-3/4" flange thickness (4 - 41.5cm width, .6 - 4.4cm thick)
- Rated 14,500 lbs. (64.4kN) at ring
- Integrated folding step (may not be used as a point of attachment)

SKU	Description	UOM	Price
REL3092	Adjustable width beam anchor	EA	\$464.21

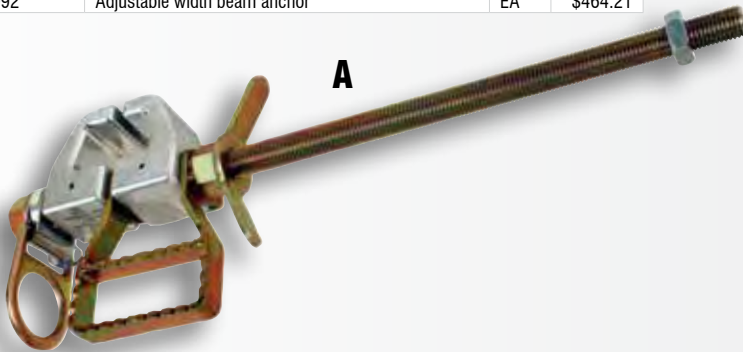

*\*Must be used with the BlackMax™ shock absorber when anchored at foot level*

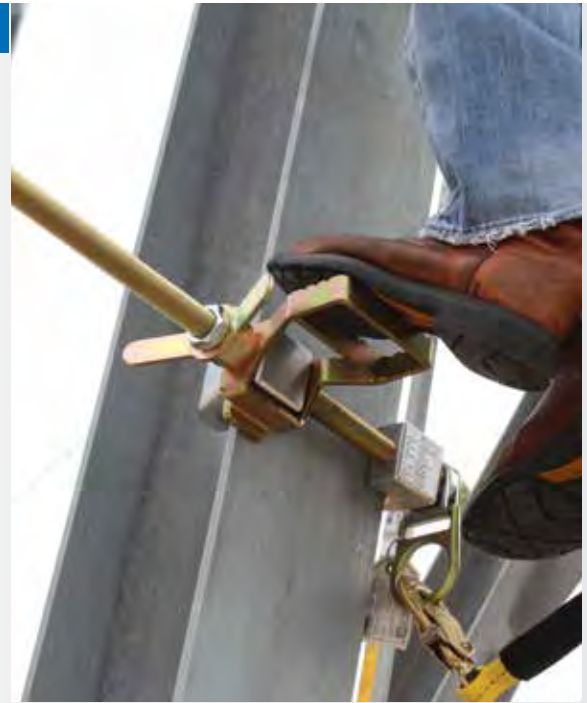

## Screwjack™ Personal Fall Arrest Anchor Clamps

The Screwjack™ Personal Fall Arrest Anchor Clamp is a lightweight adjustable anchor designed to clamp directly to the flanges of various size 'I' and 'W' style beams. A swivelling D-ring allows for a compatible attachment point of a personal fall arrest system (PFAS) for a single user. The sliding jaw can be adjusted to the needed width and placed over the beam and then secured in place with the locking detent pin. With the screw adjustment feature, the clamp can then be securely attached to vertical or inclined beams to prevent movement.

- Machined & Anodized 6161-T6 AL Aluminium & Zinc plated Alloy Steel
- Connector- Drop forged D-Ring proof loaded to 3,600 lbs. (16kN)
- Maximum Load : 5,000 lbs. (22.2kN)
- Rate for a single user
- Flange Thickness- 1/4" minimum / 1-1/8" maximum (6 - 29mm) (except 3102 - see below)

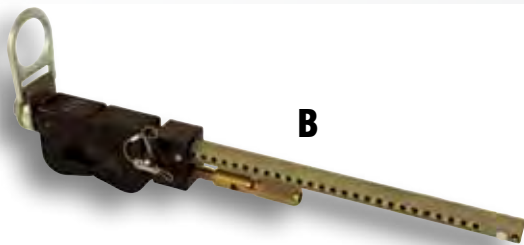

### B. Reliance® Screwjack™ Personal Fall Arrest Anchor Clamp 3100

- Fits flange widths: 3-3/4" minimum / 14" Maximum (95mm - 36cm)

SKU	Description	UOM	Price
REL3100	Screwjack™ Personal Fall Arrest Anchor Clamp 3-3/4" to 14"	EA	\$367.88

### C. Reliance® Screwjack™ Personal Fall Arrest Anchor Clamp 3102

- Fits flange widths: 5-1/4" minimum / 24" Maximum (13.3 - 61cm)
- Fits flanges from 1/4" to 3" thick 6 - 76mm)

SKU	Description	UOM	Price
REL3102	Screwjack™ Personal Fall Arrest Anchor Clamp 5-1/4" to 24" wide	EA	\$642.68

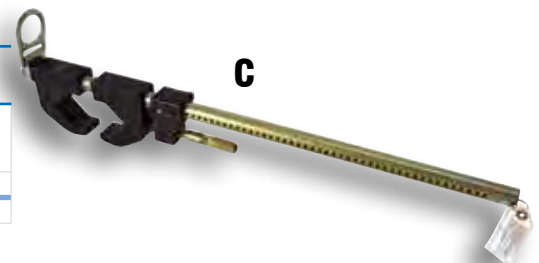



## A. Permanent (Fixed) Anchorage

Attaches to the side of vertical beams or structural steel supports. Zinc plated carbon steel.

SKU	Description	UOM	Price
REL3071	Permanent anchorage	EA	\$60.76

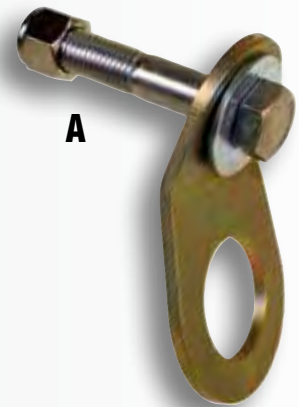

**A**

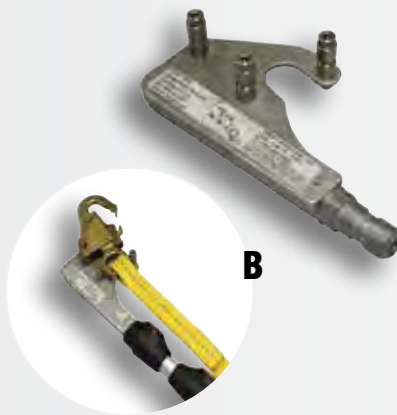

**B**

## B. Remote Snaphook Connector Tool

Attaches to end of 3022-1 pole and allows user to attach 3006 snaphook to overhead anchorage point. May also be used for a remote connection in rescue scenarios.

SKU	Description	UOM	Price
REL3021	Remote snaphook connector tool	EA	\$74.56

## C. Socket

Socket used with 3040 and 3022 pole.

SKU	Description	UOM	Price
REL3022-17	Socket used with remote pole	EA	\$119.56



**C**

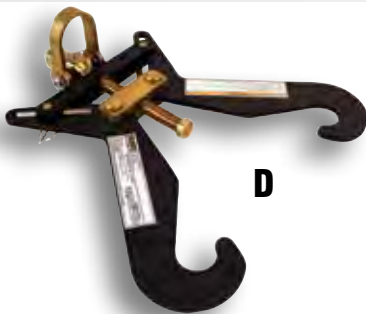

**D**

## D. Lockjaw™ Remote Beam Grip

Attaches easily to I-Beams, 5"-12" (12.7 - 30.5cm) flanges. Mounts using 302X fibreglass pole. 10,000 lb. (44.4kN) (two-man) anchorage point. Aluminium jaws, steel swivel. For overhead anchorage use only.

SKU	Description	UOM	Price
REL3040	Lockjaw™ Remote Beam Grip	EA	\$511.37

## E. Reliance® 3022-X Pole

The 3022-X pole is used with the 2260 concrete embed connector, 3040 lockjaw and the 3021 Remote Connector tool. (shown with the 2260 probe). Extends up to 13' (4m).

SKU	Description	UOM	Price
REL3022	Pole only	EA	\$195.47
REL3022-2	For use with 3040, includes socket	EA	\$282.35
REL3022-3	For use with 2260, includes 2262 probe	EA	\$222.60
REL3026	Optional pole, Extends to 5.25' (1.6m)	EA	\$160.85

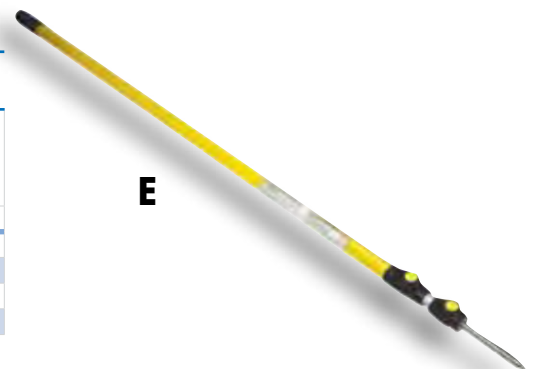

**E**



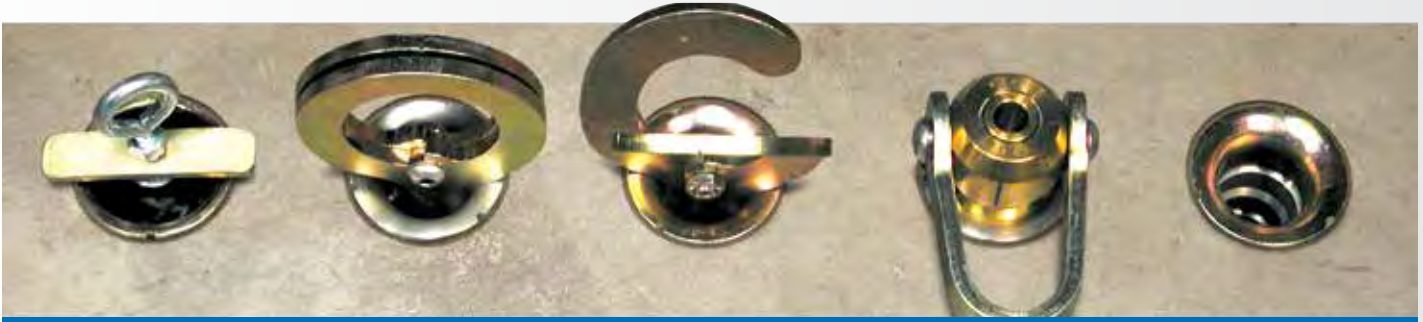

- Receiver is cast into place, to 10,000 lb. (44.4kN) anchor strength
- Ties into rebar to provide increased strength in green concrete
- One ball-lock connector can be used with numerous inexpensive receivers
- Remote connect/disconnect, up to 20' (6.1m) overhead.



### A. Metal Decking Insert

Metal Decking Insert, used to attach receiver to 2" (50mm) holes in metal decking prior to pouring concrete. Eye bolt is to remove the insert after pouring.

SKU	Description	UOM	Price
REL2243	Metal decking insert	EA	\$30.90

### B. Urethane Insert

Urethane insert holds receivers in place and keeps concrete out during pouring. May be attached to wooden or metal forms in any orientation.

SKU	Description	UOM	Price
REL2241	Urethane insert	EA	\$8.76



### C. Concrete Embed Anchor Ring

Concrete Embed Anchor Ring for permanent installation into receivers. 5,000 lb. (22.2kN) rated anchor.

SKU	Description	UOM	Price
REL2280	Concrete embed anchor ring	EA	\$136.68

### D. Concrete Embed Bypass Ring

Concrete Embed Bypass Ring for horizontal lifelines.

SKU	Description	UOM	Price
REL2270	Concrete Embed Bypass Ring	EA	\$136.68



## A. Concrete Embed Receiver and Connector

The Concrete Embed Receiver in carbon (2250) or stainless steel (2252) for outdoor or rooftop applications. Rebar passes through hole to give added strength. The Concrete Embed Connector, provides up to 10,000 lb. (44.4kN) anchor when attached to receiver. May be used for one or two man anchor or to anchor horizontal lifelines.

SKU	Description	UOM	Price
REL2250	Concrete embed receiver in zinc plated carbon steel	EA	\$30.32
REL2252	Concrete embed receiver in stainless steel	EA	\$170.40
REL2260	Concrete embed connector	EA	\$594.00

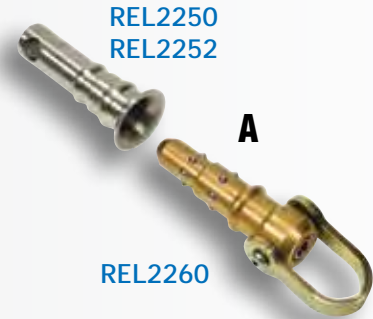

## B. Removable Concrete Anchor

These removable concrete wedge anchors are an industry staple and have been tested to meet ANSI Z359.1 and CE - EN 795. They have a long list of advantages over competitive products. A few include:

- Ease of use - simply drill the proper size hole into your concrete or rock surface, blow the dust out with compressed air, and insert the unit.
- Multi-directional attributes - RB anchors work in horizontal, vertical and overhead surfaces.
- Reusability - when your job is done, simply fill in the drilled hole if necessary and reuse at your new desired location.
- Multi-Industry -Removable Anchors can be used in construction and industrial fields wherever a substantial concrete structure is available to be utilized as an anchorage.

SKU	Description	UOM	Price
REL2267-1	Removable Concrete Anchor - 5,000 lb capacity	EA	\$130.00
REL2268-1	Removable Concrete Anchor - 10,000 lb capacity	EA	\$225.00

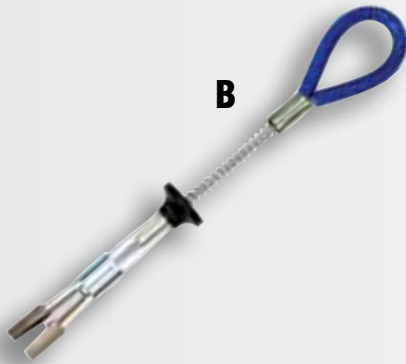

## C. Mega Swivel Anchor, Stainless Steel

The Mega-Swivel Anchor is a bolt-on d-ring anchorage connector that allows 360° of rotation and 180° of deflection to help maintain the alignment of your PFAS and to reduce incompatibility risks.

SKU	Description	UOM	Price
REL3078-1	Mega Swivel Anchor, Stainless Steel, - 5,000 lb. capacity	EA~N~	\$229.45

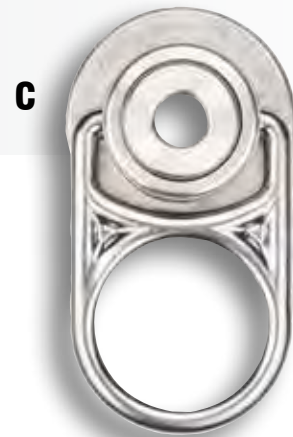

## D. Weld-on Puck Kit for Mega Swivel

The kit includes a 5/8" X 3-3/4" 304 stainless bolt, washer and lock nut and is ideal for harsh environments where corrosion is a concern.

SKU	Description	UOM	Price
REL3079-1	Weld-on Puck Kit for Mega Swivel	EA	\$69.95





## A. Specialty Anchor

Specialty stainless steel bolt-on anchorage connector designed specifically for cooling towers constructed of wood or fiberglass. May also be used effectively on steel or wood structures meeting anchorage strength requirements of 5,000 lbs or better. Anchorage connector mounts with galvanized or stainless 1/2" bolts, grade 5 or better (not included).

SKU	Description	UOM	Price
REL3107	Stainless steel specialty anchor	EA	Call for Pricing

## B. Concrete D-Ring Anchor

The Reliance Concrete D-Ring Anchor Simple, versatile and safe. Use in temporary or permanent applications. Re-usable D-ring assembly (New bolts must be used during reinstallation). Rugged design for harsh environments with no fragile parts. Safe connection indicator notifies user that anchor has been installed properly. Installs into 1 1/16", 3/4", or 18mm holes - only standard drill bits needed.

SKU	Description	UOM	Price
REL3070	Concrete D-Ring anchor	EA	\$99.44

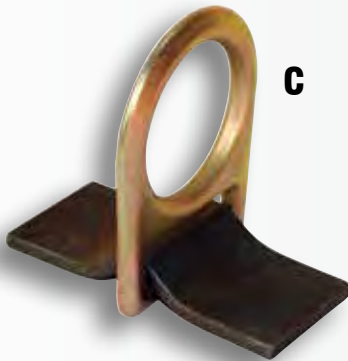
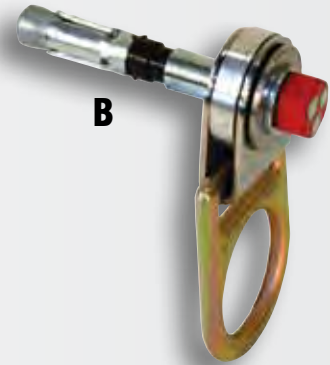

## C. Weld-on D-ring Anchor

Can be welded to structure for a permanent, rated anchor point. Formed flat bar can be painted after welding.

SKU	Description	UOM	Price
REL3068	Weld-on D-ring anchor	EA	\$21.14

## D. Single & Double-Hole High Strength Weld-On Lug

Single & double-hole high strength weld-on lug for HLL or tie-back anchorages. 14,500 lb. (64.4kN) proof load. Available in stainless or alloy steel

SKU	Description	UOM	Price
REL6158	Single-hole weld-on lug, alloy steel	EA	\$14.74
REL6160	Single-hole weld-on lug, stainless steel	EA	\$51.25
REL6161	Double-hole weld-on lug, alloy steel	EA	\$16.94
REL6162	Double-hole weld-on lug, stainless steel	EA	\$93.82

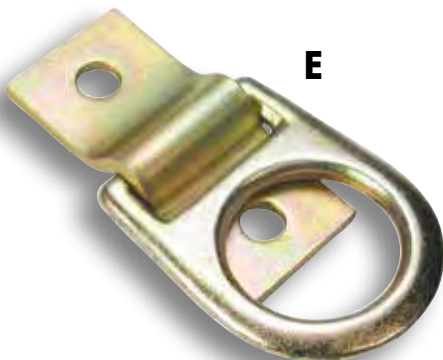

## E. Bolt-On D-Ring Anchorage

Bolts into two 1/2" (13mm) diameter drilled holes in I-beams or other structure. 5,000 lb. (22.2kN) anchorage, zinc plated carbon steel.

SKU	Description	UOM	Price
REL3066	Bolt-on D-ring anchorage	EA	\$38.67

## A. Bow Shackles

Bow shackles available 1/2" or 5/8" and in stainless steel or galvanized.

SKU	Description	UOM	Price
REL6062-1	Bow shackle 1/2" stainless steel	EA	\$23.08
REL6066	Bow shackle 5/8" stainless steel	EA	\$46.94
REL6063	Bow shackle 1/2" galvanized	EA	\$17.72
REL6067-1	Bow shackle 5/8" galvanized	EA	\$32.58

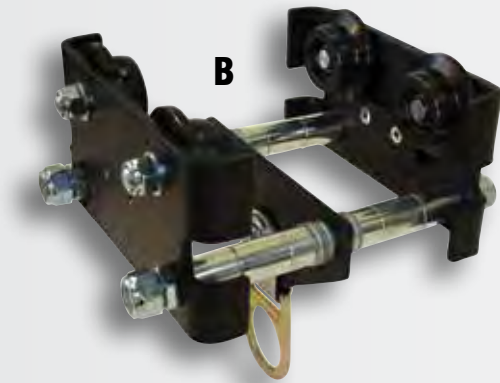

## B. Beam Trolley

Beam Trolley use on beam flanges 3 - 8.7" (76 - 220mm) wide and from 3/16 - 3/4" (4.7 - 19mm) thick. Minimum distance between flanges is 5" (13cm).

Side & Anchor Plates: Plated Alloy Steel  
 Load Bar: Zinc Plated Alloy Steel  
 Wheels: Cast Alloy Steel, Sealed Ball Bearings  
 Bow Shackle: 316 Stainless Steel (When Supplied)  
 D-Ring: Zinc Plated Alloy Steel  
 Capacity: 1 Person (310 lbs - 140kg)  
 Rated: 5,000 lbs (22.2kN)

SKU	Description	UOM	Price
REL4800-1	Beam trolley	EA	\$461.68

## C. Beam Trolley For Permanent Installation

The Beam Trolley for permanent installation on 4" to 16.5" (10.1 - 42cm) beam flanges. Complete corrosion resistant, UHMW wheels, SS bearings, powder coated aluminium body. Use anywhere: Water and steam resistant, FDA approved for contact with food products. 5,000 lb (22.2kN) single person fall arrest.

SKU	Description	UOM	Price
REL4850	Beam trolley for permanent installation	EA	\$574.71

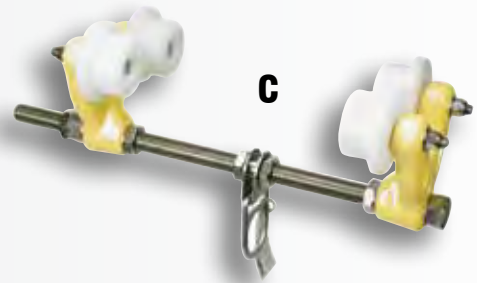

## D. Web Anchor Sling

Web Anchor Sling 9,600 lb. web sling with abrasion protector, 3" and 2" (76 & 50mm) D-rings. Available in various lengths.

SKU	Description	UOM	Price
REL680002	Web anchor sling, 1ea large D-ring, 1 ea small D-ring, 2 ft	EA	\$35.48
REL680003	Web anchor sling, 1ea large D-ring, 1 ea small D-ring, 3 ft	EA	\$35.48
REL680004	Web anchor sling, 1ea large D-ring, 1 ea small D-ring, 4 ft	EA	\$35.48
REL680005	Web anchor sling, 1ea large D-ring, 1 ea small D-ring, 5 ft	EA	\$35.48
REL680006	Web anchor sling, 1ea large D-ring, 1 ea small D-ring, 6 ft	EA	\$35.48
REL680007	Web anchor sling, 1ea large D-ring, 1 ea small D-ring, 7 ft	EA	\$43.58
REL680008	Web anchor sling, 1ea large D-ring, 1 ea small D-ring, 8 ft	EA	\$45.35
REL680009	Web anchor sling, 1ea large D-ring, 1 ea small D-ring, 9 ft	EA	\$48.08

## E. I-Beam And Concrete Beam Anchor Strap With Wear Sleeves

I-Beam Anchor Strap with wear sleeves. 3" - 28,000 lb. polyester web with four movable wear sleeves for corner protection. 6' length (6095)

Concrete Beam Anchor Strap with wear sleeves 3" - 28,000 lb. (76mm, 124.4kN) polyester web with four movable wear sleeves for corner protection. 15' length (4.5m) (6096)

SKU	Description	UOM	Price
REL6095	I-beam anchor strap with wear sleeves	EA	\$121.53
REL6096	Concrete beam anchor strap with wear sleeves	EA	\$166.05

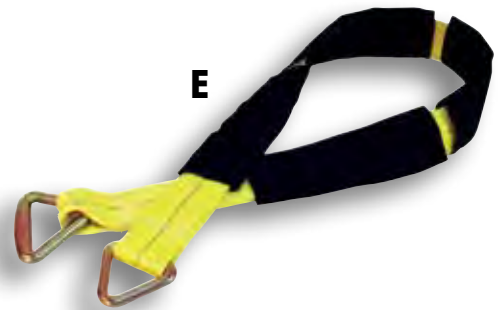





## A. 17" (43cm) Scaffold Anchor Sling with D-Ring

- 9,800 lbs strength (43.5kN)
- 1" (25mm) Tattletale® web construction

SKU	Description	UOM	Price
REL687000	17" (43cm) scaffold anchor sling with D-ring	EA	\$28.26

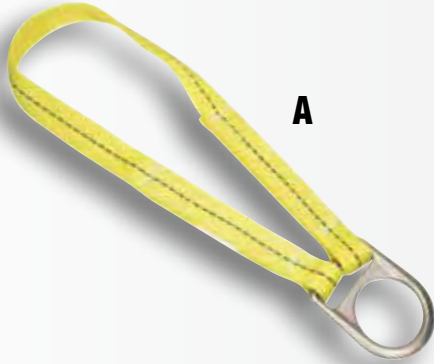

A

## B. Structural Steel Anchor

Easy, one hand operation. Fits holes with a diameter ranging from 13/16" to 7/8" (20.6 - 22mm) and a wall thickness of 3/8" to 1-9/16" (10 - 40mm). 5,000 lb. (22.2kN) rated anchorage point. Drop forged eye bolt.

SKU	Description	UOM	Price
REL3069-11	Structural steel anchor	EA	\$242.16

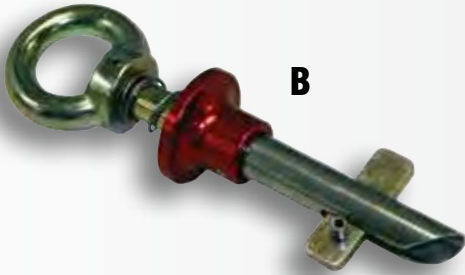

B



## C. Modified Toggle-Lock Anchor

This versatile anchorage connector was developed exclusively for Reliance to provide a secure connection in steel I-beam flanges and in hollow pre-cast concrete applications. It meets all applicable standards requirements and is rated for use by a single user.

SKU	Description	UOM	Price
REL2269-1	Modified Toggle-Lock Anchor - 2-1/8" Locking Bar	EA	\$148.25

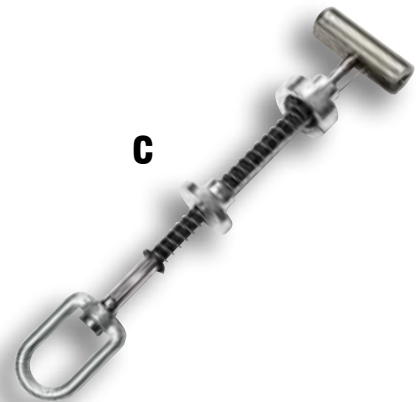

C

## A. Wire Rope Sling Anchors

Cable anchor slings are primarily designed to serve as anchor points for Personal Fall Arrest Systems. Reliance anchor slings are available in a large variety of styles, lengths, and configurations, and are suited for a variety of environments.

- Cable : 1/4" 7X19 GAC with blue vinyl coating
- Snap Hook : 3006 3,600 lb. Gateload
- Pass-Thru Rings : Zinc coated steel

SKU	Description	UOM	Price
REL714002	Cheater Cable, Anchor Extender, Pelican Hook and O-ring, 2ft	EA	\$43.78
REL714003	Cheater Cable, Anchor Extender, Pelican Hook and O-ring, 3ft	EA	\$43.78
REL714004	Cheater Cable, Anchor Extender, Pelican Hook and O-ring, 4ft	EA	\$43.78
REL714005	Cheater Cable, Anchor Extender, Pelican Hook and O-ring, 5ft	EA	\$43.78
REL714006	Cheater Cable, Anchor Extender, Pelican Hook and O-ring, 6ft	EA	\$43.78
REL714007	Cheater Cable, Anchor Extender, Pelican Hook and O-ring, 7ft	EA	\$47.05
REL714008	Cheater Cable, Anchor Extender, Pelican Hook and O-ring, 8ft	EA	\$47.95
REL714009	Cheater Cable, Anchor Extender, Pelican Hook and O-ring, 9ft	EA	\$48.98
REL714010	Cheater Cable, Anchor Extender, Pelican Hook and O-ring, 10ft	EA	\$50.71
REL714012	Cheater Cable, Anchor Extender, Pelican Hook and O-ring, 12ft	EA	\$52.03
REL714015	Cheater Cable, Anchor Extender, Pelican Hook and O-ring, 15ft	EA	\$54.84
REL714603	Cheater Cable, Pass-Thru Anchor Sling, Small and Large O-ring, 3ft	EA	\$46.92
REL714604	Cheater Cable, Pass-Thru Anchor Sling, Small and Large O-ring, 4ft	EA	\$46.92
REL714606	Cheater Cable, Pass-Thru Anchor Sling, Small and Large O-ring, 6ft	EA	\$46.92
REL714608	Cheater Cable, Pass-Thru Anchor Sling, Small and Large O-ring, 8ft	EA	\$48.92
REL714610	Cheater Cable, Pass-Thru Anchor Sling, Small and Large O-ring, 10ft	EA	\$52.92
REL714615	Cheater Cable, Pass-Thru Anchor Sling, Small and Large O-ring, 15ft	EA	\$54.92
REL714704	Cheater Cable, Basket Anchor Sling, Pelican Hook and 2 O-rings, 4ft	EA	\$54.29
REL714706	Cheater Cable, Basket Anchor Sling, Pelican Hook and 2 O-rings, 6ft	EA	\$56.37
REL714708	Cheater Cable, Basket Anchor Sling, Pelican Hook and 2 O-rings, 8ft	EA	\$58.45



REL714006

A



REL714606



REL714706



B

## B. 5-Piece Confined Space Entry System

Designed for manhole and confined space entry/retrieval and fall arrest applications. System breaks down into 5 lightweight aluminium components for easy storage, transport and set-up. No tools required for assembly. Modular design allows the use of various fixed and portable bases and an optional mast with extensions. Multiple winches and/or vertical lifeline systems may be mounted as required.

SKU	Description	UOM	Price
REL4600	5-Piece confined space entry system	EA	\$4135.81

## C. Rescue Wristlets

Designed for confined space extraction. Straps can be fitted over wrists or ankles.

SKU	Description	UOM	Price
REL722001	Rescue wristlets	EA	\$41.80



C





**A**

## A. Retrieval Lanyard

Designed for use with the 804XXX and the 814XXX series harness's from Reliance Industries. The encapsulated steel spreader bar is intended to keep the shoulder D-Rings properly spaced to prevent pinching of the neck during confined space rescue and retrieval operations.

SKU	Description	UOM	Price
REL722000	Retrieval lanyard	EA	\$80.10

## B. Rescue Ladder and Ladder Bracket

Rescue Ladder Bracket (5200) is designed to travel on a horizontal with the 2 supplied cable pulleys. Ladder can be sent to a fallen worker for rescue. Once on the ladder the worker can be hauled back to safety.

Rescue Ladder (5230) 52XX Rescue ladders are made from 1-1/4" (32mm) extruded aluminium rungs and 3/16" (4.7mm) stainless steel wire rope side rails. Comes with 2 3062-36 carabiners. Meets ANSI E1.1 Standard lengths: 10', 20', 30', 40', 50' and 60' (3, 6, 9, 12.2, 15, 18.3m). Custom lengths available.

SKU	Description	UOM	Price
REL5210	Rescue ladder 10'	EA	\$444.05
REL5220	Rescue ladder 20'	EA	\$739.37
REL5230	Rescue ladder 30'	EA	\$1148.11
REL5240	Rescue ladder 40'	EA	\$1475.53
REL5250	Rescue ladder 50'	EA	\$1800.81
REL5260	Rescue ladder 60'	EA	\$2087.98
REL5200	Rescue ladder bracket	EA	\$245.57

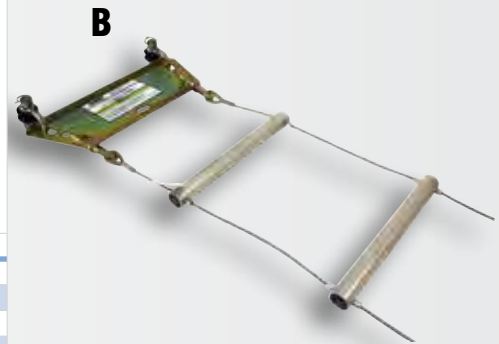

**B**



**C**

## C. Bosun's Chair

Seat board (12"x24"x1" [30.5x61x2.5cm]) Integrated tongue buckle body belt, single forged D-Ring suspension point (Must be used with additional PFAS).

SKU	Description	UOM	Price
REL885051	Bosun's chair	EA	\$123.21

## D. Confined Space Rescue Board

Designed for spine stabilization while performing confined space rescue through round hatches. Fits through 22" (56cm) hatches. Rolled 6160-T6 Aluminium.

SKU	Description	UOM	Price
REL6480	Confined space rescue board	EA	\$1101.97

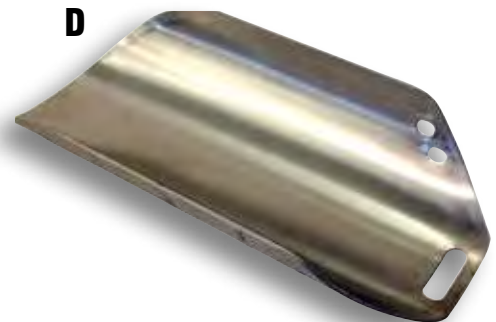

**D**

Select excerpts from applicable OSHA Standards - For Reference Only

#### Fall Protection Requirements for Steel Erection

(OSHA Subpart R1926.760)

(a) General requirements. (1) Except as provided by paragraph (a) (3) of this section, each employee engaged in a steel erection activity who is on a walking/working surface with an unprotected side or edge more than 15 feet (4.6m) above a lower level shall be protected from fall hazards by guardrail systems, safety net systems, personal fall arrest systems, positioning device systems or fall restraint systems.

#### Safety Standards for Fall Protection in the Construction Industry

(OSHA 1926.501 - Duty to have fall protection)

(a) General. (1) This section sets forth requirements for employers to provide fall protection systems. All fall protection required by this section shall conform to the criteria set forth in 1926.502 of this subpart. (b)(1) Unprotected sides and edges. Each employee on a walking/working surface (horizontal and vertical surface) with an unprotected side or edge which is 6 feet (1.8m) or more above a lower level shall be protected from falling by the use of guardrail systems, safety net systems, or personal fall arrest systems.

#### (OSHA 1926.502 - Fall protection system criteria and practices)

(a) General. (1) Fall protection systems required by this part shall comply with the applicable provisions of this section. (2) Employers shall provide and install all fall protection systems required by this support for an employee, and shall comply with all other pertinent requirements of this subpart before that employee begins the work that necessitates the fall protection. (d) Personal fall arrest systems. Personal fall arrest systems and their use shall comply with the provisions set forth below. Effective January 1, 1998, body belts are not acceptable as part of a personal fall arrest system. Note: The use of a body belt in a positioning device system is acceptable and is regulated under paragraph (e) of this section. (5) Snaphooks shall be sized to be compatible with the member to which they are connected to prevent unintentional disengagement of the snaphook by depression of the snaphook keeper by the connected member, or shall be a locking type snaphook designed and used to prevent disengagement of the snaphook by the contact of the snaphook keeper by the connected member. Effective January 1, 1998, only locking type snaphooks shall be used. (15) Anchorages used for attachment of personal fall arrest equipment shall be independent of any anchorage being used to support or suspend platforms and capable of supporting at least 5,000 pounds (22.2 kN) per employee attached, or shall be designed, installed, and used as follows: (i) as part of a complete personal fall arrest system which maintains a safety factor of at least two; and (ii) under the supervision of a qualified person. (16) Personal fall arrest systems, when stopping a fall, shall: (i) limit maximum arresting force on an employee to 900 pounds (4 kN) when used with a body belt; (ii) limit maximum arresting force on an employee to 1,800 pounds (8 kN) when used with a body harness; (iii) be rigged such that an employee can neither free fall more than 6 feet (1.8m), nor contact any lower level; (iv) bring an employee to a complete stop and limit maximum deceleration distance an employee travels to 3.5 feet (1.07m); and, (v) have sufficient strength to withstand twice the potential impact energy of an employee free falling a distance of 6 feet (1.8m), or the free fall distance permitted by the system, whichever is less. (e) Positioning device system. Positioning device systems and their use shall conform to the following provisions: (1) Positioning devices shall be rigged such that an employee cannot free fall more than 2 feet (.9m). (2) Positioning devices shall be secured to an anchorage capable of supporting at least twice the potential impact load of an employee's fall or 3,000 pounds (13.3 kN), whichever is greater.

#### (OSHA 1926.503 - Training requirements)

(a) Training Program. (1) The employer shall provide a training program for each employee who might be exposed to fall hazards. The program shall enable each employee to recognize the hazards of falling and shall train each employee in the procedures to be followed in order to minimize these hazards.

Fixed Ladders (OSHA 1910.27) (d.5) Ladder safety devices may be used on tower, water tank and chimney ladders over 20 feet in unbroken length in place of cage protection. No landing platform is required. All ladder safety devices, such as those that incorporate life belts, friction brakes, and sliding attachments, must meet the design requirements of the ladders they serve.

Powered Platforms For Building Maintenance (OSHA 1910.66) (j) Personal Fall Protection. Employers must provide personal fall arrest systems meeting the requirements outlined. Requirements include the following: Anchorages to which personal fall arrest equipment is attached shall be capable of supporting at least 5,000 pounds (22.2 kN) per employee attached, or shall be designed, installed and used as part of a complete personal fall arrest system which maintains a safety factor of at least two, under the supervision of a qualified person. Personal fall arrest systems shall, when stopping a fall: 1) limit maximum arresting force on an employee to 900 pounds (4 kN) when used with a body belt; and 2) limit maximum arresting force on an employee to 1,800 pounds (8 kN) when used with a body harness. Personal fall arrest systems shall be rigged such that an employee can neither free fall more than 6 feet (1.8m), nor contact any lower level. Personal fall arrest systems or components subjected to impact loading shall be immediately removed from service and shall not be used again for employee protection unless inspected and determined by a competent person to be undamaged and suitable for reuse. Before using a personal fall arrest system, and after any component or system is changed, employees shall be trained in accordance with the requirements of paragraph 1910.66(i)(1), in the safe use of the system. Personal fall arrest systems shall be inspected prior to each use for mildew, wear, damage and other deterioration. Defective components shall be removed from service if their strength or function may be adversely affected.

#### Permit-Required Confined Spaces (OSHA 1910.146)

(a) Scope and application. This section contains requirements for practices and procedures to protect employees in general industry from the hazards of entry into permit-required confined spaces. (k)(3) To facilitate non-entry rescue, retrieval systems or methods shall be used whenever an authorized entrant enters a permit space, unless the retrieval equipment would increase the overall risk of entry or would not contribute to the rescue of the entrant. Retrieval systems shall meet the following requirements: (i) Each authorized entrant shall use a chest or full body harness, with a retrieval line attached at the center of the entrant's back near shoulder level, above the entrant's head, or at another point which the employer can establish presents a profile small enough for the successful removal of the entrant. Wristlets may be used in lieu of the chest or full body harness if the employer can demonstrate that the use of a chest or full body harness is infeasible or creates a greater hazard and that the use of wristlets is the safest and most effective alternative.

Applicable ANSI Standards (ANSI Does not allow for reproduction of standards for reference)

- Definitions and Nomenclature Used for Fall Protection and Fall Arrest (ANSI Z359.0-2007)
- Safety requirements for Personal Fall Arrest Systems, Subsystems and Components (ANSI Z359.1-2007)
- Minimum Requirements for a Comprehensive Managed Fall Protection Program (ANSI Z359.2-2007)
- Safety Requirements for Positioning and Travel Restraint Systems (ANSI Z359.3-2007)
- Safety Requirements for Assisted-Rescue and Self-Rescue Systems, Subsystems and Components (ANSI Z359.4-2007)
- Ladder Safety Devices (ANSI A14.3-2002)
- Standard for Personal Fall Protection Used in Construction and Demolition Operations (ANSI A10.32-2004)
- ASTM F887-04 Standard Specifications for Personal Climbing Equipment
- ANSI E1.1-1999 Wire Rope Ladders







### SafetyRail 2000

Meet the World's Most Versatile and Non-Penetrating Guardrail System! Companies are using SafetyRail 2000 for: Fall Protection, Temporary Fall Protection, Roof Edge Protection, Roof Hatches, Skylights, Hazard Barriers, Warehouse Dock Doors, Warehouse Traffic Lanes, Cell Workstations, Construction Dig Sites, Dock Platforms, New Building Construction, Drive-In Truck Pits, Rail Car Platforms, Mezzanines, Break Areas, Assembly Areas, Conveyors and many more.



### The Grab Bar Roof Hatch Fall Protection

The Grab Bar allows for easy egress and ingress of roof hatches and floor hatches. Install the Grab Bars as an option to the Fall Protection Hatch Kits and make it easier and safer for workers. The Grab Bar mounts to an open receiver on the SafetyRail 2000 base. Adjust the width of the bars to the width of the ladder inside the hatch or a little wider. Lock the Grab Bars into place with the securing pin and tighten the friction collar and your done.



### Versa Clamp Portable Guardrail System

The Versa Clamp is the most versatile guardrail C-Clamp in the market place for Fall Protection. Use it on parapets as well as concrete slabs to provide the Fall Protection the workers deserve. The compression plates are off-set so not to damage copings or flashings on parapets. Its unique compression locking system makes it simple and fast to install.



Fall arrest track is available with two sizes of steel and two sizes of aluminium track in the standard fall arrest track systems. SPANCO fall arrest track equipment is designed for indoor or outdoor use. The low profile design on our fall protection system saves up to 3' (.9m) of headroom versus wire systems and the unique truss track fall arrest design enables greater distance between supported points with minimum loss of headroom. Fall arrest track systems are available in one or two man systems. Two man/two track fall protection systems allow workers to pass by each other for greater versatility.



able in one or two man systems. Two man/two track fall protection systems allow workers to pass by each other for greater versatility.



SPANCO Ceiling Mounted Fall Protection System mounted to a grain dispensing silo. System protects workers as they climb on top of rail cars to fill them with grain.



SPANCO Freestanding Fall Protection system with Long Span design. This particular system has 70' (21m) spans between supports. The system is used by workers who must access hatches on top of the rail cars.



SPANCO Rigid Lifelines Fold-Away Fall Protection System with optional motorization inside of a steel furnace bay. System shown in closed position. System utilizes dual track design, allowing two employees to pass each other without detaching from the system.



SPANCO Portable Gantry Fall Protection system used inside a large generator fabrication plant. Rolling portable gantry's gives the ability to use as needed.



SPANCO Freestanding Fall Protection system used for truck washing and tarping.



SPANCO Wall Traveling Fall Protection system with all steel construction. The system was designed for use inside of a steel mill. System is on wall mounted tracks for mobility and jib swings away when not in use.



Two SPANCO Ceiling Mounted Fall Protection systems are used to protect workers as they climb on top of large yachts.



SPANCO Rigid Lifelines Fold-Away Fall Protection system that was mounted to the outside of an existing building structure.







Today, safety on the job is considered a fundamental human right, but in the recent past, many people worked daily in dangerous conditions with little or nothing to protect them from injury. As a result, workers routinely were seriously hurt or even killed in job-related accidents. It was common practice when bidding a job to factor in fatalities or serious injuries. With the advent of OSHA in the 70's, many of the standards were not performance driven and when a worker fell from elevated heights, post investigation stated, "He was not tied-off". It took safety-minded visionaries and drive to introduce into the workplace the equipment that now allows men and women to work safely at elevated heights. Today, much progress has been made but many questions remain for applications and higher performing soft-goods and mechanicals. Our product line will continue to expand and respond to client driven needs.



Although we design and manufacture the very best in fall arrest equipment, we believe it should be the last resort. From our perspective, the at-risk worker and employer need something different if they wish to increase safety and productivity.

Our first concern, like yours, is worker safety. The lower the injury rate, the higher your profits and employee morale. The traditional safety solution is equipment oriented. But Reliance has a different idea, we believe the best way of delivering safety at heights and in confined spaces, is to find solutions that eliminate the hazards or avoid exposures to them. This reduces training and re-training burdens, provides permanent results, and increases productivity. What better way to provide safety! What other companies would rather not discuss, we put first.

But what good are the best equipment and hazard solutions if your organization and workers aren't prepared to use them and go forward independently? Reliance has developed a professional training group devoted to helping you implement your own corporate program for safety at heights and confined space entry and rescue. We can train workers, engineers, trainers and safety management personnel at your site or ours.

The Reliance perspective is simple: "the person at risk comes first." And we back that up with innovative first-rate equipment, application engineering, professional training, and corporate Fall Hazard Control programs. In short, we provide solutions, not just equipment.

Reliance offers several training options designed to take advantage of our state-of-the-art facilities and experienced training staff. Options are listed on the facing page - please contact Reliance for information regarding class dates, availability, and pricing.



## Fall Protection Competent Person • Duration : 3.5 Days

An intensive program that develops a strong overall knowledge of how to use, select, and install conventional and non-conventional fall protection equipment. Classroom lecture including slides and video, hands on scenarios applying practical workplace situations. Attendees will observe performance testing of selected components and systems. Competent person training is a pass/fail program incorporating both written and practical examinations.

### Topics Discussed:

- Fall protection theory/application per the detailed skills course
- Fundamentals of Fall Protection
  - Hierarchy of Fall Protection
  - Anatomy of a fall, 6-ft and beyond
  - Fit, form, and function of a PFAS
  - Energy Absorbers
  - Anchorage requirements
- Standards and regulations relating to Fall Protection
  - Discussion of proposed new standards
- Recognition and identification of fall hazards
- Development & implementation of Fall Protection plans & programs
- Fall Prevention Systems (e.g. handrails, guardrails, etc.)
- Fall Restraint systems (work positioning / travel restricting)
- Fall Arrest systems
- Detailed Equipment inspection & care
  - Hardware compatibility
- Transitional Fall Protection
  - Vertical and Horizontal Lifelines
  - Rigid Rails
  - Protected Access and egress
- Rescue Basics as a component of a comprehensive fall protection program.

Recommended Attendance: Managers, supervisors, safety professionals or other key personnel that may be required to develop or regulate fall protection programs, procedures and/or make on site assessments of related hazards. Participants will receive a certificate of completion and a copy of Reliance's "Competent Fall Protection Person Reference Manual" and the new ANSI Z359.1(07) standard manual.

## Fall Protection Competent Inspector • Duration : 1/2 Day (4 hours)

This course builds upon a student's practical knowledge of fall protection through the discussions of in-house testing and literature review; UV and chemical exposure to synthetic strapping and is designed to increase personal skill level through a variety of hands-on inspection exercises. This 4-hour course deals with the process of developing an inspection program and applying that to practical equipment inspection. Participants completing the course will be given the tools needed to be able to conduct competent person inspections of fall protection equipment. This course does not provide the knowledge base required for re-certification of complex hardware such as SRL's and mechanicals. Students will be provided with an inspection manual with checklists and a certificate upon completion of the course.

### Topics Discussed:

- The regulations and standards for inspection of fall arrest systems are covered in detail along with the record-keeping requirements.
- Inspection premise for harnesses, lanyards & shock absorbers, carabiners, anchorage connectors, and SRL's
- Skyline Horizontal Lifelines
- Equipment logs and recording the inspection
- Practical equipment inspections of faulty gear
- Review of technical bulletins

Participants receive a wallet-sized certificate and a copy of Reliance's "Fall Protection Equipment Inspector Manual."

## Fall Protection Competent Installer • Duration : 1/2 Day (4 hours)

An alternative to on site training. Requires a minimum of one half day of training at our Deer Park Facility. We will provide you with the necessary training and skills to take back to your facility. No-charge to users of the Skyline portable system and we will provide lunch.

### Topics Covered:

- Erect lifelines in different configurations, so that you can develop a team of installers and supervise them in proper techniques and skills. All team members expect strict maintenance of quality assurance through a continuous audit process. Installers may attend this portion of the class and continue to improve their skills while we continue with designer skills development.
- Examine plant take-off designs required to develop a transitional fall protection plan with respect to Skyline HLL and other appropriate static anchorage tools. After learning how to utilize our on-line lifeline designer, you will learn how to develop a needs assessment for your project related to required equipment components to order.
- Briefly review rescue plans in the event of a fall.
- Brief test, review, and certification.
- Provide you with PowerPoint presentation for training your installers.



### Tool & Equipment Safety Tether System

Falling object hazards from elevated locations is a serious jobsite safety concern. Reliance recognizes this hazard, and developed T.E.S.T.S. to assist in jobsite dropped object protection.

A 15 lb (6.8kg) tool dropped a distance of 6 ft (1.8m) can generate forces greater than 1000 lbs (4.4kN) when arrested with no energy absorption. To combat this issue, Reliance has developed a series of tool lanyards (patent pending) that can limit a fallen tool's arresting forces to 450 lbs (2kN) or less. Tools and equipment weighing up to 50 lbs (22.6kg) can be accommodated with this technology.

Not all tools and equipment have adequate connection points for lanyard connection. T.E.S.T.S. provides several field installable tool/equipment connectors that can withstand the potential forces that heavier dropped tools can generate.



#### Selecting the Proper Tool Connection

The method of lanyard connection to your tool or equipment is essential for safe use and operation. Reliance has tested and developed several methods for connection. The connection must have adequate strength to retain the tool or equipment when dropped. Connections may see forces as high as 450 lbs (2kN). Reliance recommends that connections be capable of withstanding forces of 1,000 lbs (4.4kN) or higher to allow for a factor of safety. Anchor point must also be capable of withstanding 1,000 lbs (4.4kN).

#### T.E.S.T.S.™ Components & Connection Methods



REL799955 Tool Lanyard  
For tools up to 50 lbs (23kg)

REL799953 Tool Lanyard For  
tools up to 15 lbs (7kg).



#### Direct Connect

Tools and equipment with connection points of adequate size and strength can be connected directly to the lanyard with the supplied spring hook. When using Tool Lanyard REL799955, the label end should be connected to an acceptable anchor point.



REL799971 Light / REL799973 Heavy Rings  
For tools up to 20 lbs (9kg) [REL799971]  
& 50 lbs (23kg) [REL799973] that have  
no adequate means for connecting the  
tool lanyard. REL799971 installed using  
the REL799960 3/8" (9.6mm) banding;  
REL799973 installed using the REL799962  
1/2" (13mm) banding. (sold in pks of 10)



#### Anchor Ring Connect

Tools or equipment that do not have a built in method of connection can be retrofitted with an Anchor Ring.



REL799980 Anchor Loop  
For tools or equipment that have an anchor  
hole or slot, but too small or positioned  
where the standard spring hook cannot be  
inserted.



#### Anchor Loop

Tools or equipment with holes or slots that are not sized to allow for the direct connect method may use the REL99980 anchor loop. Simply insert loop through hole or slot and pass aluminum swage button through loop. Pull button tight to choke wire rope around the tool. \*May only be used on tools weighing 30 lbs or less



REL799952 Tool Lanyard  
For tools up to 5 lbs (2.3kg)



#### Multiple Anchor Rings

In some cases more than one anchor ring may be needed and installed on the same tool. For example, cordless tools with removable battery packs need Anchor Rings on both the tool and battery pack. Items weighing 5 lbs (2.3kg) or less may be secured with the REL799952 tool lanyard as shown.



# RELIANCE™

fall protection

## T.E.S.T.S.™ Tool Lanyard Series

### Tool & Equipment Safety Tether System



Anchor rings are installed on an irregular shaped tools (or tools that lack an appropriate connector slot) utilizing the REL799990 tool shown here. Banding is available in both the 3/8" and 1/2" (9.6mm & 13mm) sizes, for connection to tools or equipment weighing up to 20 lbs and 50 lbs (9kg & 23kg) respectively. Scru-Lok Buckles secure the banding, and both banding and buckles are available

#### T.E.S.T.S.™ Fastening Equipment

REL799990 Tension Tool  
For application of banding to irregular shaped tools.



REL799962 1/2" (13mm) Banding  
Used on tools up to 30 lbs (13kg) with a single wrap and up to 50 lbs (23kg) with a double wrap of banding. Banding is tensioned using the REL799990 Tension Tool and locked in place with the REL799963 1/2" (13mm) Scru-Lok Buckle. Available in 100' (30m) rolls.

REL799960 3/8" (9.6mm) Banding  
Used on tools weighing up to 20 lbs (9kg). Banding is tensioned using the REL799990 Tension Tool and locked in place with the REL799961 3/8" (9.6mm) Scru-Lok Buckle. Available in 100' (30m) rolls.

REL799963 - Box of 25 1/2" (12.7mm) Scru-Lok Buckles  
REL799961 - Box of 50 3/8" (9.4mm) Scru-Lok Buckles  
*\*Allen wrench included in box*

REL799971 - Bag of 10 Light Duty Anchor Rings  
REL799973 - Bag of 10 Heavy Duty Anchor Rings



*Banding with anchor ring - shown with Scru-Lok buckle attached*

*Banding with anchor ring installed, ready for sizing, tightening, and trimming. Please see instruction manual for full details.*



#### Quick Selection Guide

Part #	Tool Equipment Weight				
	0-5 lbs	5-15 lbs	15-20 lbs	20-30 lbs	30-50 lbs
REL799950		Do Not Use	Do Not Use	Do Not Use	Do Not Use
REL799952		Do Not Use	Do Not Use	Do Not Use	Do Not Use
REL799953			Do Not Use	Do Not Use	Do Not Use
REL799955					
REL799960				Do Not Use	Do Not Use
REL799962 Single Wrap					Do Not Use
REL799962 Double Wrap					
REL799971				Do Not Use	Do Not Use
REL799973					
REL799980					Do Not Use







### A. Reliance® T.E.S.T.S.™ Elastic Tool Lanyard

The REL799950 Elastic Tool Lanyard is designed to secure tools to a person or object to prevent inadvertent dropping. Initial length is 26" and can elongate to 42". Comes with an 80 mm carabiner and rubberized loop with a ball lock for additional anchoring/attachment options.

SKU	Description	UOM	Price
REL799950	Elastic tool lanyard	EA	\$11.29

### B. Reliance® T.E.S.T.S.™ Coiled Tool Lanyard

The REL799952 Coiled Tool Lanyard is designed to secure tools to a person or object to prevent inadvertent dropping. Comes with an 80 mm carabiner and rubberized loop with a ball lock for additional anchoring/attachment options. 5 lb max tool weight.

SKU	Description	UOM	Price
REL799952	Coiled tool lanyard	EA	\$8.72



### C. Reliance® T.E.S.T.S.™ Tool Lanyard

The REL799953 Tool Lanyard is designed to secure tools to a person or object to prevent inadvertent dropping. Initial length is 38" and can elongate to 63". Comes with 2 spring hooks for anchoring/attachment options. Up to 15 lb max tool weight.

SKU	Description	UOM	Price
REL799953	Tool lanyard up to 15 lb max tool weight	EA	\$20.06

### D. Reliance® T.E.S.T.S.™ Tool Lanyard

The REL799955 Tool Lanyard is designed to secure tools to a structure capable of supporting 1,000 lbs to prevent inadvertent dropping. Initial length is 38" and can elongate to 63". Comes with 2 spring hooks for anchoring/attachment options. Up to 50 lb max tool weight.

SKU	Description	UOM	Price
REL799955	Tool lanyard up to 50 lb max tool weight	EA	\$27.80





### A. Squids® 3100 Single Carabiner Tool Lanyard - 10lb

Tool Lanyard-Single Carabiner: Tethers tools to help worker prevent injury, damage and lost productivity from dropped tools.

SKU	Description	UOM	Price
ERG3100STD	Single Carabiner Tool Lanyard 35" - 42"	EA	\$8.46
ERG3100EXTD	Single Carabiner Tool Lanyard Extended 42" - 54"	EA	\$8.70

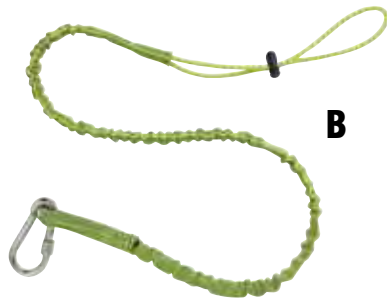

### B. Squids® 3101 Stainless Steel Carabiner Tool Lanyard - 15lb

Stainless Steel Screw Gate Tool Lanyard - Single Carabiner: Stainless steel carabiners with locking screw gates for a sure connection in more corrosive environments.

SKU	Description	UOM	Price
ERG3101	Stainless Steel Carabiner Tool Lanyard 35" - 42"	EA	\$14.97



### C. Squids® 3110 Dual Carabiner Tool Lanyard - 10lb

Tool Lanyard-Dual Carabiners tethers tools to help worker prevent injury, damage and lost productivity from dropped tools.

SKU	Description	UOM	Price
ERG3110STD	Dual Carabiner Tool Lanyard 35" - 42"	EA	\$10.41
ERG3110EXTD	Dual Carabiner Tool Lanyard Extended 42" - 54"	EA	\$10.74



### D. Squids® 3115 Wrist Tool Lanyard - 2lb

Wrist Tool Lanyard: Tethers tools to help worker prevent injury, damage and lost productivity from dropped tools.

SKU	Description	UOM	Price
ERG3115	Wrist Tool Lanyard Tether Length 7.5"	EA	\$2.11



### E. Squids® 3155 Elastic Hard Hat Lanyard With Clamp

Elastic Hard Hat Lanyard with Clamp: Easily and comfortably secures a hard hat to a worker to prevent the item from falling.

SKU	Description	UOM	Price
ERG3155	Elastic Hard Hat Lanyard With Clamp	EA	\$3.82



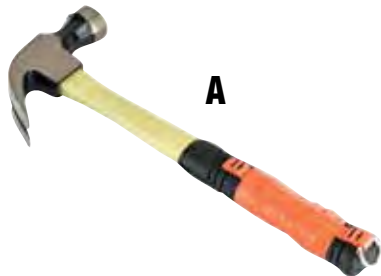

### A. Squids® 3700 Web Tool Tails™ - 2lb

Web Tool Tails™ provide retrofit attachment points to a variety of tools and equipment up to 2lbs (0.90kg) using Squids® Tool Traps™.

SKU	Description	UOM	Price
ERG3700	Web Tool Tails™ - 2lb	EA	\$6.91



### B. Squids® 3703 Elastic Loop Tool Tails™ - 15lbs

Elastic loop Tool Tails™ provide retrofit attachment points to a variety of tools and equipment up to 15lbs (6.8kg) using Squids® Tool Traps™. These Tool Tails can also be used as an anchor point on belt, harness or separate structure.

SKU	Description	UOM	Price
ERG3703	Elastic Loop Tool Tails™ - 15lbs	EA	\$8.86



### C. Squids® 3713 Elastic Loop Tool Tails™ Swivel - 10lbs

Elastic loop Tool Tails™ provide retrofit attachment points to a variety of tools and equipment up to 10lbs (4.6kg) using Squids® Tool Traps™. These Tool Tails can also be used as an anchor point on belt, harness or separate structure.

SKU	Description	UOM	Price
ERG3713	Elastic Loop Tool Tails™ Swivel - 10lbs	EA	\$11.31

### D. Squids® Cold Shrink Trap™

Cold Shrink Traps capture Squids® Elastic Tool Tails™ creating a retrofit connection point for tethering. Maximum capacity depending on tool, tail and lanyard used.

SKU	Description	UOM	Price
ERG3723	Cold Shrink Trap™ Tool Diameter 0.75" - 1.50" Max. Cap. 5lbs	EA	\$8.38
ERG3724	Cold Shrink Trap™ Tool Diameter 1.25" - 1.75" Max. Cap. 10lbs	EA	\$10.00
ERG3726	Cold Shrink Trap™ Tool Diameter 1.75" - 2.50" Max. Cap. 15lbs	EA	\$14.56



### E. Squids® Tape Trap™

Captures Squids® Tool Tails™ securing a safe connection to tools like no other tool attachment tape on the market. Quickly wraps on a variety of hand tools, power tools and other equipment providing security and added grip.

SKU	Description	UOM	Price
ERG3750S	Tape Trap™ 12ft Roll	RL	\$16.19
ERG3750M	Tape Trap™ 30ft Roll	RL	\$37.35



**A. Arsenal® Leather Bottom Buckets**

Leather Bottom Bucket: High wall, heavy duty bucket for strength and durability. Rope handle.

SKU	Description	UOM	Price
ERG5730	Leather bottom bucket	EA	\$85.68
ERG5740	Leather bottom bucket with swivel snap	EA	\$94.47
ERG5738	Canvas safety top 12.5" dia	EA	\$26.52



**B. Arsenal® Small Plastic Bottom Bucket**

Small Plastic Bottom Bucket: Small size for easy toting and lighter loads. Rope handle.

SKU	Description	UOM	Price
ERG5734	Small plastic bottom bucket	EA	\$45.97
ERG5744	Small plastic bucket with swivel snap	EA	\$54.19
ERG5739	Canvas safety top 10" dia.	EA	\$23.27



**C. Arsenal® 5725 Topped Bolt Bag**

Topped Bolt Bag with Loop Design: Wide body and one-handed cinch-up top for keeping gear safe and secure.

SKU	Description	UOM	Price
ERG5725	Topped Bolt Bag	EA	\$32.30



**D. Arsenal® Topped Parts Pouch**

Topped Parts Pouch has a hands-free, self-closing trap door closure that prevents small parts, hardware, and tools from falling when working at heights.

SKU	Description	UOM	Price
ERG5538	Topped Parts Pouch - Orange Tarpaulin	EA	\$35.00
ERG5528	Topped Parts Pouch - Black Canvas	EA	\$35.00

**E. Arsenal® 5516 Topped Tool Pouch - Strap Attachment**

Topped Tool Pouch easily attaches to any fall protection harness while keeping tools and fasteners secure.

SKU	Description	UOM	Price
ERG5516	Topped Tool Pouch - Strap Attachment	EA	\$57.20







### A. Python Trigger2Trigger Tool Lanyards



Used in combination with Python Safety D-Rings and Quick Rings, Trigger2Trigger Tool Lanyards are an economical tethering solutions for most hand tools. Pull down on the trigger to open the dual-hooked connector, then release once latched to a tool. Trigger2Trigger Tool Lanyards come in varying lengths, and are third-party load-rated for 10 lbs.

SKU	Description	UOM	Price
PYTEXT2T12	Double Trigger EXT 0.5 X 12	EA	\$10.72
PYTEXT2T24	Double Trigger EXT 0.5 X 24	EA	\$11.39
PYTEXT2T2410	Double Trigger EXT 0.5 X 12 10/pk	PK	\$113.82
PYTEXT2T36	Double Trigger EXT 0.5 X 36	EA	\$12.73

### B. Python Hook2Loop Bungee Tether

The Hook2Loop Bungee Tether is a very versatile extension that can be used with virtually anything under 10 lbs: spud wrenches, scaffold wrenches, adjustable wrenches, etc.

SKU	Description	UOM	Price
PYTEXTH2LB	Hook2Loop Bungee Tether	EA	\$18.70
PYTEXTH2LB10	Hook2Loop Bungee Tether 10/pk	PK	\$186.16
PYTEXTH2LBUN	Hook2Loop Bungee Tether Medium Duty	EA	\$40.13



PYTDR0510PK PYTDR1X3510

### C. Python D-Rings

D-Ring Attachment Points are used together with Quick Wrap and Heat Shrink to create attachment points for a huge collection of tools. D-Rings come in a wide variety of sizes, and are each third-party load-rated.

SKU	Description	UOM	Price
PYTDR0510PK	D-Rings D-Ring 0.5" X 2.25", Max Load:2 lbs (0.9 kg) 10/pk	PK	\$42.94
PYTDR1X3510	D-Rings D-Ring 1" X 3.5", Max Load:5 lbs (2.7 kg) 10/pk	PK	\$46.62
PYTDR05NC10	D-Rings D-Ring 0.5" X 2.25" Non-Conductive, Max Load:2 lbs (0.9 kg) 10/pk	PK	\$42.94

### D. Python Tool Cinch MD Attachments

Python Safety Tool Cinch MD Attachment Points feature a unique cinch design that allows users to quickly secure even the most difficult to tether tools, and continue their work. Simply cinch the tool, and secure the stabilization wings using Quick Wrap Tape to create an instant attachment for virtually any tool up to 35lbs.

SKU	Description	UOM	Price
PYTVR2ATTM	Tool Cinch MD Attachments	EA	\$26.74
PYTVR2ATTM10	Tool Cinch MD Attachments 10/pk	PK	\$266.55

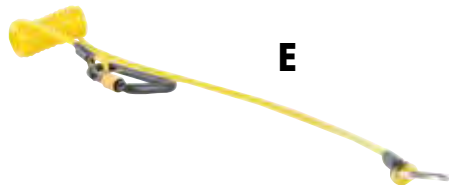
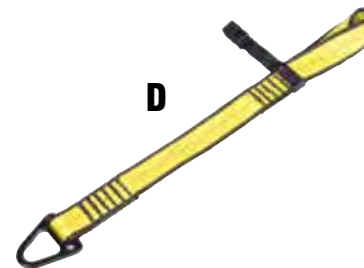

### E. Python Hook2Quick Ring Coil with Tail

Designed to be used with hammers and the Python Safety Hammer Holster, the Hook2Quick Ring Coil with Tail is the ideal tether for hammers. Vinyl-coated braided steel makes the tether durable, easy to clean, and work well around heat.

SKU	Description	UOM	Price
PYTEXTH2QR	Hook2Quick Ring Coil with Tail	EA	\$22.72
PYTEXTH2QR10	Hook2Quick Ring Coil with Tail 10/pk	PK	\$214.30

### F. Python Adjustable Wristband

Wristband adjusts in size with hook and loop. 1" ballistic nylon D-Ring, 2" wide elastic webbing

SKU	Description	UOM	Price
PYTWBADJ10	Adjustable Wristband 10/pk	PK	\$199.56
PYTWBADJRE10	Adjustable Wristband with Retractor 10/pk	PK	\$333.53





### A. Python Hard Hat Tether

Heavy-duty steel industrial clip with simple flip-up snap allows for easy one-handed operation. 5 1/2" tail with loop makes the Hard Hat Tether easy to attach to any hard hat. Compact design keeps the tether out of the way when not in use.

SKU	Description	UOM	Price
PYTEXTHH10	Python Hard Hat Tether 10/pk	PK	\$132.57
PYTEXTHH100	Python Hard Hat Tether 100/pk	PK	\$1065.07



**B**

### B. Python Heat Shrink Link

After using Python Safety Quick Wrap Tape and D-Rings to create an attachment point, Heat Shrink is used to create an even stronger connection that is more resistant to abrasives and harsh environments. Links shrink 300% in size, while an inner adhesive securely fastens itself to whatever is being wrapped.

SKU	Description	UOM	Price
PYTHS075X175	Heat Shrink Link 0.75 X 1.75 25/pk	PK	\$30.14
PYTHS15X2	Heat Shrink Link 1.5 X 2 25/pk	PK	\$36.84
PYTHS15X3	Heat Shrink Link 1.5 X 3 25/pk	PK	\$48.57
PYTHS1X175	Heat Shrink Link 1 X 1.75 25/pk	PK	\$31.83
PYTHS2X4	Heat Shrink Link 2 X 4 10/pk	PK	\$57.61
PYTHS3X4	Heat Shrink Link 3 X 4 10/pk	PK	\$81.72

### C. Python Quick Wrap Tape

Made from a self-fusing silicone rubber, Python Safety Quick Wrap Tape is capable of creating instant attachment points for nearly any tool in a matter of seconds. Quick Wrap Tape conforms to the shape of whatever it is applied to, making it ideal for even the most irregular shaped tools.

SKU	Description	UOM	Price
PYTQWHDBL1	Quick Wrap Tape blue 1" x 108"	EA	\$22.07
PYTQWHGDN1	Quick Wrap Tape green 1" x 108"	EA	\$22.07
PYTQWHDYL1	Quick Wrap Tape yellow 1" x 108"	EA	\$22.07



**D**

### D. Python Safe Buckets

Sewn into the bottom of every Safe Bucket is hard composite plating that protects the bucket from accidental punctures. A protective leather sleeve covers the inserts that is resilient to the elements and harsh work environments.

SKU	Description	UOM	Price
PYTBKT100DRA	Safe Bucket 100lb with Drawstring	EA	\$133.90
PYTBKT100HLC	Safe Bucket 100lb Load Rated	EA	\$133.91
PYTBKT250DRA	Safe Bucket 250lb with Drawstring	EA	\$133.39
PYTBKT250HLV	Safe Bucket 250lb Load RATED	EA	\$133.91

### E. Python Small Parts Pouches

Designed with Drop Prevention in mind, the patented Python Safety Small Parts Pouch stops accidental drops the moment something is put inside. With an innovative self-closure system that traps objects inside, the Small Parts Pouch makes it nearly impossible for objects to fall out once placed in the bag, while making it easy for retrieval by the user since no opening or closing is necessary.

SKU	Description	UOM	Price
PYTPCHPARTCB	Small Parts Pouches Canvas Black	EA	\$80.33
PYTPCHPARTCC	Small Parts Pouches Canvas Camo	EA	\$80.33
PYTPCHPARTCO	Small Parts Pouches Canvas Orange	EA	\$80.33







**A**

### A. Python Tool Pouches

The Python Safety Tool Pouch comes in two sizes, with three variants of each size. Constructed from a heavy duty canvas, with an inner lining to help prevent punctures, this rugged tool pouch is engineered to last. Multiple inner pockets accommodate a number of tools, while built in D-Rings makes tethering tools incredibly easy.

SKU	Description	UOM	Price
PYTPCHTOOLRE	Tool Pouches with D-rings and Retractors	EA	\$100.42
PYTPCHTOOLTR	Tool Pouches with D-rings and Triggers	EA	\$87.02

### B. Python Tool Holster (Belt)

Constructed from a premium heavy duty ballistic denier fabric and high density webbing, the Belt Holster is engineered to withstand punishing environments. Heavy-duty 1" D-Rings are built into both sides of the holster and are load-rated for 5lbs. A neoprene pocket on the front of the holster accommodates an optional retractor. *Note: Tool lanyards not included.*

SKU	Description	UOM	Price
PYTHOL1TBLTR	Single Tool Holster Ret (Belt)	EA	\$68.27
PYTHOL1TOOLB	Single Tool Holster (Belt)	EA	\$60.23
PYTHOL2TBLTR	Dual Tool Holster Ret (Belt)	EA	\$93.72



**B**

PYTHOL1TBLTR

PYTHOL2TBLTR



**C**

### C. Python Adjustable Radio Holster

The Python Safety Adjustable Radio Holster is specially designed to adjust perfectly to the size of virtually any portable radio, as well as other small devices such as cell phones and cameras. A unique mounting system allows the holster to attach easily to harnesses and tool belts.

SKU	Description	UOM	Price
PYTHOLARAD	Adjustable Radio Holster	EA	\$22.07
PYTHOLARADCO	Adjustable Radio Holster Combo with Clip2Loop Tether	EA	\$30.65

### D. Python Scaffold Wrench Holster

The Python Safety Scaffold Wrench Holster offers a rear feed retractor system that allows the worker to safely work off of the belt with the added convenience of a retractable lanyard that is third party tested for 1.5lbs (0.7kg). D-Rings on the holster allow heavier tools to be secured using a tool lanyard. A pull down security strap prevents the scaffold wrench from leaving the holster during transit.

SKU	Description	UOM	Price
PYTHOLSCAFFC	Scaffold Wrench Holster with Hook2Loop Bungee Tether	EA	\$61.35
PYTHOLSCAFFW	Scaffold Wrench Holster with Retractor	EA	\$53.53



**D**



**E**

### E. Python Dual Tool Holster

Constructed from a premium heavy duty ballistic denier fabric and high density webbing, the dual tool holster for the belt is engineered to withstand punishing environments. Two heavy-duty 1" D-Rings are built into both sides of the holster and are load-rated for 5lbs. A pocket on the front of the holster accommodates up to two optional retractors.

SKU	Description	UOM	Price
PYTHOL2TOOLB	Dual Tool Holster (Belt)	EA	\$55.22
PYTHOL2THARR	Dual Tool Holster with Retractor (Harness)	EA	\$93.72

**A. Vertical Debris Netting, FR Treated**

High-density knitted polyethylene mesh with open mesh, approximately 1/4". Built with reinforced selvaged edges. Lightweight and easy to Install. U.V. treated, flame retardant and fluorescent orange.

SKU	Description	Mesh Size	Roll Size	Color	UOM	Price
STRSB	Vertical debris netting	Approx 3/8"	5' 6" x 150'	Flor. Orange	RL	\$260.53
STRSBN22-8	Vertical debris netting	Approx 3/8"	8'6" x 150'	Flor Orange	RL	\$315.70

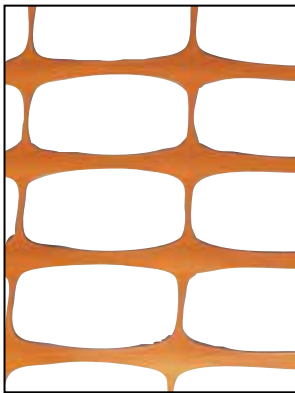
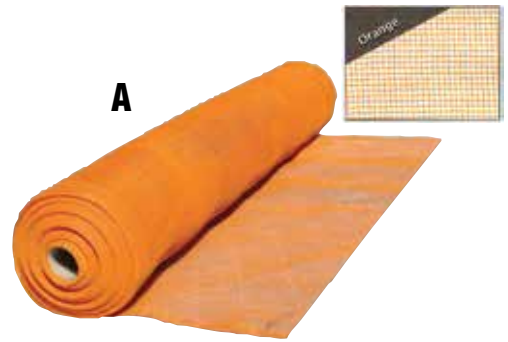

**B**



**B. Perimeter Plus™**

Plastic fencing that combines the best in visibility and versatility. The fencing has been carefully developed to meet your needs for durable, highly visible temporary barriers. temperature service range 0 °F to 200 °F. Ultraviolet stabilized for extended outdoor use. Mesh opening is 1.8 x 3.38".

SKU	Description	Roll WT	Roll Size	Color	UOM	Price
X05650-002	Perimeter Plus	13 lbs	4' x 100'	Orange	RL ~N~	\$27.06

*For a full listing and online ordering visit our website at:*  
**[www.gosafe.com](http://www.gosafe.com)**



Safety begins with us...

Sign In Register Now View Cart Order Status My Account

Home Products - About Medsafe Catalog Contact Us

All Categories Search







**A**

### A. Lynx® Rescuer

Lynx Rescuer is a Self Retracting lanyard with emergency retrieval capabilities. Users are able to reset device from retrieval mode to fall arrest mode making it the easiest, quickest field-reset mechanism on the market. Lock feature with key allows more control over who can reset unit to fall arrest mode. Same unit can be used in the field and for training situations. Meets all applicable ANSI standards and OSHA regulations.

SKU	Description	Length	UOM	Price
ROS10011744	Lynx rescuer	50'	EA	\$2125.81
ROS10011745	Lynx rescuer	95'	EA	\$2524.41

### B. Lynx Confined Space Entry Kits

Confined space entry kits make it easy for you to order the confined space system which best suits your needs. Features include:

- 3 tripod kits and 2 folding davit kits
- Single part number for simplified ordering
- Confined space kits with Lynx Rescuer allows for non-entry rescue of a confined space entrant
- Tripod and davit kits allow for great portability

SKU	Description	Rescuer	Lynx Hoist	UOM	Price
ROS10023969	Lynx davit confined space entry kit #1	-	X	EA	\$3746.81
ROS10024020	Lynx davit confined space entry kit #2	X	X	EA	\$6101.96
ROS10016569	Side mount Lynx hoist w/emergency drive			EA	\$2211.40
ROS506222	Split mount pulley			EA	\$112.95
ROS506232	Bracket for Lynx rescue mount 30' & 50'			EA	\$290.73
ROS506473	Pulley/bracket assembly			EA	\$254.06
ROS507151	Carrying bag for Lynx rescue hoist			EA	\$103.80



**B**



**C**

### C. Suretyman™ Rescue Utility System

4 to 1 rescue pulley system with anti-reversing pulleys for means of rescue in a confined space application or rescue from heights. The Suretyman Rescue Utility System incorporates all the features professionals have come to expect from a first class rescue system. The system is primarily used for raising and lowering people or equipment in rescue and industrial work access and is ideal for confined space applications. Rated capacity of 600 lb for personnel and materials. Standard rope length of 200' with a maximum rope length of 600'.

SKU	Description	UOM	Price
ROSSRS15200	Suretyman rescue utility system	EA	\$1445.17

### D. Dyna-Line® Horizontal Lifeline

The Dyna-Line Horizontal Lifeline system is used as an anchorage connector in a personal fall arrest system. It is designed for quick and easy installation and removal. It's made with a 12-strand rope that will not hockle and that has very low stretch properties. It is available in single worker and two worker systems, and in standard lengths of 30' or 60'. Up to 200' Dyna-Line lengths are available by special order. The Dyna-Line comes in bucket for easy transportation and storage. The Dyna-Line can be mounted to any suitable 5,000 pound rated anchorage point. The lifeline has an integral line tensioner that allows proper tensioning of the lifeline before use. Meets all applicable OSHA and ANSI standards. Kit includes: Lifeline, Line Tensioner, Snaphook Attachments, Connecting Ring, Handy Bucket carrying container.

SKU	Description	UOM	Price
ROS10013152	Dyna-Line horizontal lifeline, 30 ft. 2-man system	EA	\$717.60
ROS10013153	Dyna-Line horizontal lifeline, 60 ft. 2-man system	EA	\$779.63
ROS10019085	Dyna-Line horizontal lifeline, 100 ft. 2-man system	EA	\$862.31



**D**

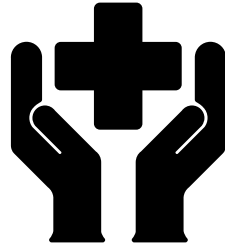

KEEP YOUR  
HANDSAFE



# Hand Protection





# Hand Protection

## Cut Resistant

### Terms and Definitions

**ANSI/ISEA 105** - American National Standard for Hand Protection: Voluntary US standard for gloves.

**ASTM F1790** - Test method specified under ANSI/ISEA 105 to measure cut resistance.

**CPPT** - Cut Protection Performance Test: Test machinery used to perform ASTM F1790. A test sample is cut by a straight edge blade, under load, that moves along a straight path. The sample is cut five times each at three different loads and the data is used to determine the required load to cut through the sample at a reference distance of 20 mm. (0.8 inches). This is referred to as the Rating Force or Cutting Force. The higher the Rating Force, the more cut resistant the material. Cut resistance is measured in grams and converted to levels.

**CE** - Committee de European

**EN 388** - Set of CE Test Standards for Mechanical Hazards: Abrasion Resistance, Blade Cut Resistance, Tear Resistance and Puncture Resistance.

**Couptest Tester** - Machinery used to determine cut resistance under CE/EN 388. A circular blade, under a fixed load, moves back and forth across the sample until cut-through is achieved. A cotton canvas fabric is used as the reference material. The reference material and test sample are cut alternatively until at least five results are obtained. The cut resistance is a ration of the number of cycles needed to cut through the test sample vs. the reference material. This is referred to as the cut index. The higher the cut index, the more cut resistant the material. The cut index is converted to levels.

### HANDSAFE Glove Cut Resistance Information Tables

Glove SKU #	Description	ANSI/ISEA 105	EN 388	Page #
MSGCHVO	HANDSAFE Nitrile Palm Coated, Hi-Vis Orange	Cut Level 4	Cut Level 5	113
MSGC4LAT	HANDSAFE Latex Palm Coated, Hi-Vis Orange	Cut Level 4	Cut Level 5	113
MSGC4DPO	HANDSAFE Dorsal Impact Nitrile Palm, Hi-Vis Orange	Cut Level 4	Cut Level 5	113

### Cordova Glove Cut Resistance Information Tables

Glove SKU #	Description	ASTM F1790 (CPPT)	CE/EN 388	Page #
MSG3757	Monarch™ Split Leather Palm	Cut Level 4	Cut Level 5	115
MSG3752	Monarch™ Black Polyurethane Palm Coating	Cut Level 3	Cut Level 5	115
MSG3755	Monarch™ Black HCT-Nitrile Coating	Cut Level 3	Cut Level 5	115
MSG3758	Monarch™ Black Crinkle Latex Coating	Cut Level 3	Cut Level 5	115
MSG3070	Kevlar® String Knit Gloves	Cut Level 3	N/A	116
MSG3055	Kevlar® Gloves with Nitrile Palms	Cut Level 2	Cut Level 2	116
MSG3710	White Dyneema® Shell/Polyurethane Standard	Cut Level 1	Cut Level 3	116
MSG3710G	Gray Dyneema® Shell/Polyurethane Standard	Cut Level 1	Cut Level 3	116
MSG3700	White Dyneema® Shell/Polyurethane Premium	Cut Level 1	Cut Level 3	116
MSG3700G	Gray Dyneema® Shell/Polyurethane Premium	Cut Level 1	Cut Level 4	116

### Ansell Glove Cut Resistance Information Tables

Glove SKU #	Description	ANSI/ISEA 105	EN 388	Page #
ANS11-501	HyFlex® 11-501 CR+	Cut Level 4	Cut Level 4	114
ANS11-500	HyFlex® 11-500 CR	Cut Level 2	Cut Level 2	114
ANS11-510	HyFlex® 11-510 DuPont™ Kevlar® Stretch Liner	Cut Level 2	Cut Level 3	114
ANS11-624	HyFlex® 11-624 Dyneema	Cut Level 2	Cut Level 3	114

### HexArmor Glove Cut Resistance Information Tables

Glove SKU #	Description	ANSI/ISEA 105	EN 388	Page #
HEX9011	Level Six Nitrile Rubber Coated	Cut Level 5	Cut Level 5	117
HEX9010	Level Six Nitrile Palm Coated	Cut Level 5	Cut Level 5	117



CE-EN 388	
Abrasion Level	Level 4
Cut Level	Level 5
Tear Level	Level 4
Puncture Level	Level 2
ANSI / ISEA-105	
Cut Level	Level 4
Weight	1,840 Grams

### HANSAFE Cut Resistant Gloves

13 gauge, high visibility yellow, cut 4 string knit shell combined with an orange foam nitrile or latex palm coating. The MSGC4DPO features a sewn on TPR that provides cut and back of hand protection. High visibility colors certification markings imprinted on back of glove. ANSI Cut Level 4, CE Cut Level 5

SKU	Description	Size	UOM	Price
MSGC4HVO	HANSAFE Nitrile Palm Coated, Hi-Vis Orange	S-2X	PR	\$8.50
MSGC4LAT	HANSAFE Latex Palm Coated, Hi-Vis Orange	S-2X	PR	\$8.50
MSGC4DPO	HANSAFE Dorsal Impact Nitrile Palm, Hi-Vis Orange	S-2X	PR	\$19.99

#### Washing Instructions

Wash using warm water and commercial laundry detergent. Water temperature not to exceed 50° C/ 122° F. Air-dry or tumble-dry with low heat. Do not disinfect with bleach.





### A. HyFlex® 11-500 CR with Kevlar® Glove

HyFlex® CR has a cut-resistant stretch Kevlar® liner; is coated with unique, foam nitrile; and is an excellent choice when working with sharp-edged materials and tools. The stretch Kevlar® lining provides a comfortable fit with excellent protection from nuisance nicks and abrasion and the extended cuff offers extra cut protection around the wrist. The foam nitrile coating channels away oil from the surface of the gloves, providing a sure grip in light oil applications and features a soil-hiding black palm coating. ANSI/ISEA 105 - Cut Level 2, EN 388 - Cut Level 2

SKU	Description	Size	UOM	Price
ANS11-500	HyFlex CR with Kevlar Glove	6-11	DZ	\$72.60

### B. HyFlex® 11-501 CR+ Intercept Technology Glove

Featuring Intercept Technology, jointly developed by Ansell and DuPont, this yarn incorporates Kevlar® Stretch Armor Technology for an unprecedented combination of superior cut resistance and outstanding dexterity. Superior HyFlex oil grip, tactile sensitivity, dexterity and comfort. Cut prevention improves productivity, profitability and employee morale. ANSI/ISEA 105 - Cut Level 4, EN 388 - Cut Level 4

SKU	Description	Size	UOM	Price
ANS11501-7	HyFlex CR+ intercept technology	7	DZ	\$168.20
ANS11501-8	HyFlex CR+ intercept technology	8	DZ	\$168.20
ANS11501-9	HyFlex CR+ intercept technology	9	DZ	\$168.20
ANS11501-10	HyFlex CR+ intercept technology	10	DZ	\$168.20
ANS11501-11	HyFlex CR+ intercept technology	11	DZ	\$168.20



### C. HyFlex® 11-510 DuPont™ Kevlar® Stretch Liner With Spandex

The Ansell 11-510 DuPont™ Kevlar® stretch liner with spandex glove features a patented Nylon and Kevlar® zonal plaiting on palm and back. To give the wearer a soft feel it also incorporates the ComfortFlex cuff. The black foam nitrile coated palm provides enhanced grip in light oil conditions and is silicone-free and latex-free for worker and product protection. ANSI/ISEA 105 - Cut Level 2, EN 388 - Cut Level 3

SKU	Description	Size	UOM	Price
ANS11-510	HyFlex DuPont Kevlar stretch liner with spandex	6-11	DZ	\$83.58

### D. HyFlex® 11-624 Dyneema Glove

HyFlex® 11-624 gloves feature an exclusive yarn combination of DSM Dyneema®, Spandex and nylon. HyFlex® 11-624 gloves offer the highest degree of cut protection, yet they are lightweight, cool, comfortable and highly flexible. A polyurethane black coating provides a medium high level of abrasion resistance while promoting a sure-grip in dry and wet applications and extending product life by not showing strains from wear. ANSI/ISEA 105 - Cut Level 2, EN 388 - Cut Level 3

SKU	Description	Size	UOM	Price
ANS11-624	HyFlex Dyneema	6-11	DZ	\$107.37





### A. Monarch™ Black Polyurethane Palm Coating

Black, 13-Gauge Shell, Made with Taeki 5 Fiber, Black Polyurethane Palm Coating. ASTM F1790 (CPPT) - Cut Level 3, CE/EN 388 - Cut Level 5

SKU	Description	Size	UOM	Price
MSG3752	Monarch™ black polyurethane palm coating, cut level 5	S-L	PR	\$7.56
MSG3752XL	Monarch™ black polyurethane palm coating, cut level 5	XL	PR	\$8.52
MSG37522X	Monarch™ black polyurethane palm coating, cut level 5	2X	PR	\$7.57



### B. Monarch™ Black HCT-Nitrile Coating

Salt & Pepper, 13-Gauge Shell, Made with Taeki 5 Fiber, Black HCT-Nitrile Coating. ASTM F1790 (CPPT) - Cut Level 3, CE/EN 388 - Cut Level 5

SKU	Description	Size	UOM	Price
MSG3755	Monarch™ HCT-nitrile coating, cut level 5	L	PR	\$8.30

### C. Monarch™ Split Leather Palm

Salt & Pepper, 10-Gauge Shell, Made with Taeki 5 Fiber with Split Leather Palm. Stitched with Kevlar Thread. ASTM F1790 (CPPT) - Cut Level 4, CE/EN 388 - Cut Level 5

SKU	Description	Size	UOM	Price
MSG3757	Monarch™ split leather palm, cut level 5	S-L	PR	\$11.92
MSG3757XL	Monarch™ split leather palm, cut level 5	XL	PR	\$11.92
MSG3757XXL	Monarch™ split leather palm, cut level 5	2X	PR	\$11.92



### D. Monarch™ Black Crinkle Latex Coating

Black, 13-Gauge Shell, Made with Taeki 5 Fiber with Black Crinkle Latex Coating. ASTM F1790 (CPPT) - Cut Level 3, CE/EN 388 - Cut Level 5

SKU	Description	Size	UOM	Price
MSG3758	Monarch™ NRL-black crinkle latex coating, cut level 5	S-L	PR	\$7.89
MSG3758XL	Monarch™ NRL-black crinkle latex coating, cut level 5	XL	PR	\$7.89

### E. ION-A4™

13-Gauge, Mandarin Orange, High Performance Polyethylene (HPPE)/Glass Fiber Shell, Black Sandy Nitrile Palm Coating, CE/EN: 4542, CE Cut Level 4, ANSI Cut Level 2: 1559 grams.

SKU	Description	Size	UOM	Price
MSG3702	ION-A4 orange polyethylene coating, cut level 4	XS-2X	PR	\$9.98





# Hand Protection

## Cut Resistant



### A. White Dyneema® Shell/Polyurethane Palm Coated Gloves

Cut resistant gloves feature high performance Dyneema fiber, and string knit shell construction with polyurethane coated palms. They are more flexible, comfortable and conduct heat and moisture better than others. Because Dyneema is unaffected by water or detergents, and is highly-resistant to abrasion, these gloves can be washed and re-used without any loss of cut resistance. Made with USDA/FDA accepted materials for use in food processing applications.  
 MSG3700: ASTM F1790 (CPPT) - Cut Level 1, CE/EN 388 - Cut Level 3  
 MSG3710: ASTM F1790 (CPPT) - Cut Level 1, CE/EN 388 - Cut Level 3

SKU	Description	Size	UOM	Price
MSG3700	Dyneema shell/polyurethane coated, premium cut resistant	S-L	PR	\$7.89
MSG3700XL	Dyneema shell/polyurethane coated, premium cut resistant	XL	PR	\$8.52
MSG37002X	Dyneema shell/polyurethane coated, premium cut resistant	2X	PR	\$7.89
MSG3710	Dyneema shell/polyurethane coated, standard cut resistant	S-L	PR	\$6.28
MSG3710XL	Dyneema shell/polyurethane coated, standard cut resistant	XL	PR	\$6.28

### B. Gray Dyneema® Shell/Polyurethane Palm Coated Gloves

MSG3700G: ASTM F1790 (CPPT) - Cut Level 1, CE/EN 388 - Cut Level 4  
 MSG3710G: ASTM F1790 (CPPT) - Cut Level 1, CE/EN 388 - Cut Level 3

SKU	Description	Size	UOM	Price
MSG3700G	Dyneema shell/polyurethane coated, premium cut resistant	XS-L	PR	\$8.30
MSG3700GXL	Dyneema shell/polyurethane coated, premium cut resistant	XL	PR	\$8.29
MSG3700G2X	Dyneema shell/polyurethane coated, premium cut resistant	2X	PR	\$8.29
MSG3710G	Dyneema shell/polyurethane coated, standard cut resistant	S-L	PR	\$6.28
MSG3710GM	Dyneema shell/polyurethane coated, standard cut resistant	XL	PR	\$6.28



### C. Kevlar® Gloves with Nitrile Palms

Kevlar/lycra string knit gloves with foam nitrile coated palms. ASTM F1790 (CPPT) - Cut Level 2, CE/EN 388 - Cut Level 2

SKU	Description	Size	UOM	Price
MSG3055	Kevlar/lycra string knit gloves, nitrile palm coated	S-L	DZ	\$57.35
MSG3055XL	Kevlar/lycra string knit gloves, nitrile palm coated	XL	DZ	\$63.40

### D. Kevlar® String Knit Gloves

Dupont Kevlar for high tensile strength relative to its weight - up to five times stronger than steel. Will not melt, ignite or conduct electricity. High durability in cut resistance. High comfort level. Allows manual dexterity. Made with FDA approved materials for use in food processing applications. Use as gloves or glove liners. The 100% Kevlar cut-resistant, string knit gloves are 7 gauge, medium weight.

MSG3070: ASTM F1790 (CPPT) - Cut Level 3  
 MSG3075: ASTM F1790 (CPPT) - Cut Level 3

SKU	Description	Size	UOM	Price
MSG3070	100% Kevlar string knit gloves	S-L	DZ	\$56.96
MSG3070XL	100% Kevlar string knit gloves	XL	DZ	\$60.17
MSG3075	100% Kevlar PVC dotted string knit gloves	S-L	DZ	\$58.16
MSG3075XL	100% Kevlar PVC dotted string knit gloves	XL	DZ	\$61.38



## A. Level Six Nitrile Rubber Coated

Level Six Series gloves set the new standard for hand protection by combining industrial puncture protection with industry leading cut resistance. Made with SuperFabric® brand material for the highest cut-resistance available on the market- Exceeds ISEA/CE Level 5 (in noted enhanced areas). Innovative industrial puncture protection on enhanced areas from wires, metal, wood, and glass. Comfortable cotton blend shell with wrinkle rubber palm coating for exceptional dexterity and feel.

SKU	Description	Size	UOM	Price
HEX9011	Level Six glove nitrile palm coated, cut level 5	S-XL	PR	\$14.95
HEX90112X	Level Six glove nitrile palm coated, cut level 5	2X	PR	\$16.76



HexArmor Protection Zone- ISEA CUT: 5

## B. Level Six Nitrile Palm Coated

Level Six Series gloves set the new standard for hand protection by combining industrial puncture protection with industry leading cut resistance. HexArmor® products are engineered to provide the highest levels of protection in areas where risk is the greatest. Experience the Science of Safety™ that has helped reduce injuries and lower PPE costs in the harshest work environments. Made with SuperFabric® brand material for the highest cut-resistance available on the market- Exceeds ISEA/CE Level 5 (in noted enhanced areas). Cut-resistant HPPE shell with flat nitrile palm coating for great oily or dry grip- ISEA Level 4

SKU	Description	Size	UOM	Price
HEX9010	Level Six glove nitrile palm coated, cut level 5	S-L	PR	\$25.73
HEX9010XL	Level Six glove nitrile palm coated, cut level 5	XL	PR	\$25.72
HEX90102X	Level Six glove nitrile palm coated, cut level 5	2X	PR	\$29.39



HexArmor Protection Zone- ISEA CUT: 5  
HPPE Shell - ISEA CUT: 4

## C. Rig Lizard® Thin Lizzie™ 2090

The Rig Lizard® Thin Lizzie™ 2090 is made from a HPPE and glass fiber blend shell. It's a lightweight, form-fitting, cut-resistant glove with maximum dexterity. Like all Rig Lizard® Series gloves, the 2090 features a newly redesigned high-flex IR-X® Impact Exoskeleton™, which delivers critical back-of-hand impact protection that won't cause hand fatigue or restrict movement. This glove was built to help you perform by keeping your hands safe and comfortable all day long.

SKU	Description	Size	UOM	Price
HEX2090	Rig Lizard® Thin Lizzie™	S-2X	PR	\$26.48



HexArmor Protection Zone  
HPPE Blend Shell - ISEA CUT:4 CE 4543

## D. Chrome Core Oasis™ 4035

Comfort shouldn't be a luxury, and we at HexArmor® know that safety certainly isn't. That's the reasoning behind our Chrome Core Oasis™ 4035 – a sleek, hi-vis mechanic's glove with a SuperFabric® brand material palm and a HexVent® back of hand. Built to beat the heat, the Chrome Core Oasis™ 4035 also beats laceration hazards with the most advanced technology on the market. With features such as our pre-curved design and double-stitched side seams, you won't have to give up dexterity for the highest level of safety. Our patented SlipFit® cuff also means an easy on and off between jobs.

SKU	Description	Size	UOM	Price
HEX4035	Chrome Core Oasis™	S-XL	PR	\$35.96
HEX40352X	Chrome Core Oasis™	2X	PR	\$38.18



HexArmor SuperFabric® Protection Zone- ISEA CUT: 5

# Hand Protection

Cut Resistant \ Impact



A



■ HexArmor Protection Zone - ISEA CUT:5 CE 4513  
■ Impact Protection

## A. Chrome Series® Leather 4080

The Chrome Series® Leather Impact 4080 combines old-school comfort with modern protection, providing your hands with the highest levels of cut and puncture protection, using an interior layer of SuperFabric® brand material, and an abrasion resistant leather shell.

SKU	Description	Size	UOM	Price
HEX4080	Chrome Series® Leather	S-XL	PR	\$44.04
HEX40802X	Chrome Series® Leather	2X	PR	\$47.32

## B. Chrome™ Series: Cut Level 5 Impact Hi-Vis

Over 25 times the cut resistance of the mechanics' gloves you're wearing right now, and over 10 times the cut resistance of Kevlar®! Sound crazy? Not with the Chrome Series™ from HexArmor. We've invested millions of dollars perfecting technology and PPE designs to shatter current ratings for cut and abrasion resistance. It's time to ditch the flashy, non-protective mechanics' gloves, and upgrade to the Chrome Series™.

SKU	Description	Size	UOM	Price
HEX4026	Chrome Series glove hi-viz green cut level 5 impact	S-L	PR	\$37.95
HEX4026XL	Chrome Series glove hi-viz green cut level 5 impact	XL	PR	\$37.95
HEX40262X	Chrome Series glove hi-viz green cut level 5 impact	2X	PR	\$42.91
HEX40263X	Chrome Series glove hi-viz green cut level 5 impact	3X	PR	\$42.91

B



■ HexArmor Protection Zone - ISEA CUT:5 CE 4542  
■ Impact Protection



C



■ HexArmor Protection Zone - ISEA CUT:3 CE 4243  
■ Impact Protection

## C. Rig Lizard® 2021

The Rig Lizard® sets a new precedent for oil, gas, and mining safety gloves. HexArmor's advanced TP-X™ technology combines the unmistakable grip advantages of a synthetic palm with the scientific innovation that made HexArmor® the thought leader in PPE development. After safety supervisors across the industry helped identify common on-site hazards, anything less than our full-hand Impact Exoskeleton™ simply would not suffice. Combine these features with a pre-curve design, double palm stitch, and HexArmor's maximum-comfort fingertip design, and you've unlocked the dexterity and protection needed for optimum performance.

SKU	Description	Size	UOM	Price
HEX2021	Rig Lizard glove cut level 3 impact	XS-XL	PR	\$32.84
HEX20212X	Rig Lizard glove cut level 3 impact	2X	PR	\$35.37

## D. Rig Lizard Arctic® TP-X+® Palm 2026

The Rig Lizard Arctic® 2026 uses a C100 Thinsulate™ liner to provide maximum warmth, while our H2X® liner creates a waterproof barrier for your hands. And to make this the most well-rounded winter work glove available, we added a durable and abrasion resistant TP-X+® palm for maintaining grip in both wet and dry situations.

SKU	Description	Size	UOM	Price
HEX2026	Rig Lizard Arctic® TP-X+® Palm	S-XL	PR	\$49.06
HEX20262X	Rig Lizard Arctic® TP-X+® Palm	2X	PR	\$55.10
HEX20263X	Rig Lizard Arctic® TP-X+® Palm	3X	PR	\$55.10

D



■ HexArmor Protection Zone - ISEA CUT:4 CE 4343  
■ Impact Protection





### A. GGT5® 4020

Introducing the 4020 GGT5®, the most complete glove for the oil and gas industry. Gator Grip Technology® is a design platform that combines high performance materials engineered to provide industry-leading cut and puncture protection, and the strongest grip in any oil situation.

SKU	Description	Size	UOM	Price
HEX4020	GGT5 glove green/yellow palm cut level 5	S-L	PR	\$47.11
HEX4020XL	GGT5 glove green/yellow palm cut level 5	XL	PR	\$47.11
HEX40202X	GGT5 glove green/yellow palm cut level 5	2X	PR	\$50.79
HEX40203X	GGT5 glove green/yellow palm cut level 5	3X	PR	\$50.79

A



■ HexArmor Protection Zone - ISEA CUT:5 CE 4542  
■ Impact Protection



B

### B. GGT5® Mud 4021X

Introducing the 4021 GGT5®, the most complete glove for the oil and gas industry. Mud Grip Technology® is a design platform that combines high performance materials engineered to provide industry-leading cut and puncture protection, and strong grip in light/medium oil situations.

SKU	Description	Size	UOM	Price
HEX4021	GGT5 Mud Grip glove orange palm cut level 5	S-L	PR	\$49.73
HEX4021XL	GGT5 Mud Grip glove orange palm cut level 5	XL	PR	\$49.74
HEX40212X	GGT5 Mud Grip glove orange palm cut level 5	2X	PR	\$54.35
HEX40213X	GGT5 Mud Grip glove orange palm cut level 5	3X	PR	\$54.35



■ HexArmor Protection Zone - ISEA CUT:5 CE 4542  
■ Impact Protection

### C. The Ugly Mudder® 7210

When working with oils, muds, and other liquids in an environment with cut hazards, there's only one glove to reach for. The HexArmor® Ugly Mudder® 7210 adds a layer of protective guardplates to the interior of the palm providing ANSI/ISEA level 4 cut resistance. This is in addition to the integrated continuous back-of-hand impact protection guards, and the abrasion and liquid resistance offered by the premium PVC coating. Additionally, the 7210 features a textured palm for added grip and durability when dealing with fluids.

SKU	Description	Size	UOM	Price
HEX7210	The Ugly Mudder® 7210	M-XL	PR	\$38.18

C



■ HexArmor Protection Zone - ISEA CUT:4 CE PENDING  
■ Impact Protection



D

### D. The Ugly Mudder® 7301

If you're working with oils, muds, and other liquids all day long, you know how uncomfortable it can be to wear saturated gloves. Not only is it unpleasant, but some substances can cause skin irritation or allergic reactions. HexArmor® developed The Mudder® 7301 for tasks that demand impact protection and liquid resistance. PVC coating and gauntlet-style cuff keep liquids out of the glove and away from your hand, while the IR-X® Impact Exoskeleton™ protects against smashes and pinches.

SKU	Description	Size	UOM	Price
HEX7301	The Ugly Mudder® 7301	M-XL	PR	\$24.20



■ Impact Protection





### A. R2 Safety Rigger Glove with Long Neoprene Cuff - Orange

R2 Safety has 4 way stretch spandex in back of hand, Parity™ synthetic leather palm with Clarino™ palm and finger patches, TRP knuckle, finger and back of hand protection, extended Kevlar® reinforced thumb saddle, Parity™ synthetic forchettes, oil resistant palm with hi vis red silicone pattern for better visibility and grip, ID tag on cuff to place name to protect investment, neoprene cuff with spandex for added comfort.

Features:

- TPR finger, hand and knuckle guards to protect against bumps & bruises
- Reinforced thermoplastic fingertips to reduce pinches; extended Kevlar™ reinforced thumb saddle
- Flexible 4-way stretch form fitting spandex back with Hi Visibility fabric and oil resistant palm providing excellent grip in wet applications

SKU	Description	Size	UOM	Price
WCHE86712	R2 safety rigger glove with long neoprene cuff - orange	S-L	PR	\$25.14
WCHE86712XL	R2 safety rigger glove with long neoprene cuff - orange	XL	PR	\$25.14
WCHE867122X	R2 safety rigger glove with long neoprene cuff - orange	2X	PR	\$25.14
WCHE867123X	R2 safety rigger glove with long neoprene cuff - orange	3X	PR	\$25.14

### B. R2 Safety Rigger Glove with Hook & Loop Elastic Wrist – Orange

R2 Safety has 4 way stretch spandex in back of hand, Parity™ synthetic leather palm with Clarino™ palm and finger patches, TRP knuckle, finger and back of hand protection, extended Kevlar® reinforced thumb saddle, Parity™ synthetic forchettes, oil resistant palm with hi vis red silicone pattern for better visibility and grip, ID tag on cuff to place name to protect investment, neoprene cuff with spandex for added comfort.

Features:

- TPR finger, hand and knuckle guards to protect against bumps & bruises
- Reinforced thermoplastic fingertips to reduce pinches; extended Kevlar™ reinforced thumb saddle
- Flexible 4-way stretch form fitting spandex back with Hi Visibility fabric and oil resistant palm providing excellent grip in wet applications

SKU	Description	Size	UOM	Price
WCHE86713	R2 safety rigger glove with hook & loop elastic wrist – orange	S-L	PR	\$25.14
WCHE86713XL	R2 safety rigger glove with hook & loop elastic wrist – orange	XL	PR	\$25.14
WCHE867132X	R2 safety rigger glove with hook & loop elastic wrist – orange	2X	PR	\$25.14



### C. R2 Winter Fleece Orange

R2 Winter Glove has 4 way stretch spandex in back of hand, Parity™ synthetic leather palm with Clarino™ palm and finger patches, TPR knuckle, finger and back of hand protection, Kevlar® reinforced thumb saddle, Parity™ synthetic forchettes, oil resistant palm with silicone pattern that provides excellent grip, fleece lining for warmth, waterproof Enprotex® lining, ID tag on cuff to place name to protect investment, neoprene extended safety cuff with spandex for added comfort

Features:

- TPR finger, hand and knuckle guards to protect against bumps & bruises
- Reinforced thermoplastic fingertips to reduce pinches; Kevlar reinforced thumb saddle
- Flexible 4-way stretch form fitting spandex back with Hi Visibility fabric and oil resistant palm providing excellent grip in wet applications, fleece lining with Enprotex®

SKU	Description	Size	UOM	Price
WCHE86711	R2 winter fleece orange	M-L	PR	\$32.55
WCHE86711XL	R2 winter fleece orange	XL	PR	\$32.55
WCHE867112X	R2 winter fleece orange	2X	PR	\$32.55



### A. OGRE-Impact™

The 7735 OGRE-Impact™ Glove features a hi-vis lime nylon shell, black sandy nitrile palm coating, interior foam palm padding, Kevlar® reinforced thumb crotch and Thermo-Plastic Rubber (TPR) reinforced fingers, and back of hand.

SKU	Description	Size	UOM	Price
MSG7735	OGRE-Impact Glove, Lime Nylon Shell, Nitrile Palm	M-2X	PR	\$13.13



**B**



### B. OGRE-KV™

The OGRE-KV™ Glove features a Kevlar® reinforced fabric palm reinforced thumb crotch, lime four-way stretch spandex back, TPR knuckles, fingers, back of hand, wrist, and pull tab and neoprene cuff with gusset. ANSI Cut Level 3, 1038 Grams

SKU	Description	Size	UOM	Price
MSG7740	OGRE-KV Glove, Kevlar® Reinforced Fabric Palm	M-3X	PR	\$34.95

### C. OGRE™ Corded Canvas Palm

The 7720 OGRE™ Glove features a hi-vis green back, corded canvas palm and Micro-Porous Hipora® Inserts.

SKU	Description	Size	UOM	Price
MSG7720	OGRE Glove, Corded Canvas Palm	M-3X	PR	\$16.68



**D**



### D. OGRE-CR™

Salt & Pepper, 13-Gauge, HPPE (High Performance Polyethylene) Shell, Gray Polyurethane Palm Coating, Thermo-Plastic Rubber (TPR) Finger and Back of Hand Protectors, CE/EN388: 4341, CE Cut Level 3, ANSI Cut Level 2: 581 grams.

SKU	Description	Size	UOM	Price
MSG7736	OGRE-CR™ HPPE Shell, Gray Polyurethane Palm Coating	S-2X	PR	





### A. Latex Dipped Work Gloves

Cor-Grip II is a standard, gray 10-gauge glove with a poly/cotton shell and with a gray crinkle finish latex coating. Made with FDA accepted materials for food processing applications.

SKU	Description	Size	UOM	Price
MSG3895	10 gauge poly/cotton shell, textured latex palm coating	S-L	DZ	\$18.29
MSG3895XL	10 gauge poly/cotton shell, textured latex palm coating	XL	DZ	\$17.22



### B. Premium Blue Latex Dipped Gloves

CorGrip® premium blue latex palm coated string knit gloves with a gray color shell. Made of 10 gauge, gray knit.

SKU	Description	Size	UOM	Price
MSG3896	10 gauge poly/cotton shell, textured latex palm coating	S-L	DZ	\$19.90
MSG3896XL	10 gauge poly/cotton shell, textured latex palm coating	XL	DZ	\$19.70



### C. String Knit Gloves with Blue Latex Palms

Blue latex palm coated gloves are standard weight and have a natural colored string knit shell.

SKU	Description	Size	UOM	Price
MSG3893	String knit gloves with blue latex palms	S-L	DZ	\$8.86
MSG3893XL	String knit gloves with blue latex palms	XL	DZ	\$8.86
MSG3892	String knit gloves with green latex palms	S-L	DZ	\$8.86
MSG3892XL	String knit gloves with green latex palms	XL	DZ	\$8.57

### D. COLD SNAP™ High Dexterity, Thermal, Latex Coated Gloves

This 7-gauge, high dexterity, green loop-in, brushed acrylic terry shell with black foam latex coated palm glove can be used in applications such commercial fishing, cold storage and construction. Safe for food contact.

SKU	Description	Size	UOM	Price
MSG3999	Cold Snap green with black foam latex	S-L	DZ	\$40.60
MSG3999XL	Cold Snap green with black foam latex	XL	DZ	\$40.60





### A. Conquest™

Stretchable Seamless Spandex Shell conforms to hands for exact fit and exceptional comfort. Flexible Foam Nitrile palm coating provide durability while minimizing hand fatigue. Maximum tactile sensitivity for precision assembly and handling of small parts. The Conquest Glove features a gray seamless nylon/spandex shell with a foam nitrile palm coating.

SKU	Description	Size	UOM	Price
MSG6905	Conquest Glove Black Nitrile Palm	S-2X	DZ	\$29.49



### B. Conquest™ XTRA

Stretchable Seamless Spandex Shell conforms to hands for exact fit and exceptional comfort. Flexible Foam Nitrile palm coating provide durability while minimizing hand fatigue. Maximum tactile sensitivity for precision assembly and handling of small parts. The Conquest Glove features a gray nylon/spandex shell with a foam nitrile 3/4 coating.

SKU	Description	Size	UOM	Price
MSG6910	Conquest Glove Black Nitrile 3/4 Coating	XS-2X	DZ	\$31.10



### C. Conquest™ PLUS

Stretchable Seamless Spandex Shell conforms to hands for exact fit and exceptional comfort. Flexible Foam Nitrile palm coating provide durability while minimizing hand fatigue. Maximum tactile sensitivity for precision assembly and handling of small parts. The Conquest Glove features a gray nylon/spandex shell with a foam nitrile palm coating with dots.

SKU	Description	Size	UOM	Price
MSG6915	Conquest Glove Black Nitrile Palm and Dots	S-2X	DZ	\$32.63



### D. Conquest™ MAX

Stretchable Seamless Spandex Shell conforms to hands for exact fit and exceptional comfort. Flexible Foam Nitrile palm coating provide durability while minimizing hand fatigue. Maximum tactile sensitivity for precision assembly and handling of small parts. The Conquest Glove features a gray nylon/spandex shell with a foam nitrile 3/4 coating with dots.

SKU	Description	Size	UOM	Price
MSG6920	Conquest Glove Black Nitrile 3/4 Coating and Dots	XS-2X	DZ	\$35.04



### A. Standard Nylon Shell with Polyurethane Coating

13-gauge, seamless nylon glove with black color shell and gray polyurethane palm coat.

SKU	Description	Size	UOM	Price
MSG6896C	Black nylon gloves with black polyurethane palms	S-L	DZ	\$10.70
MSG6896CXL	Black nylon gloves with black polyurethane palms	XL	DZ	\$10.71

### B. Cor-Touch Foam Plus

The Cor-Touch Foam Plus Glove has a black 13-gauge nylon shell with a black 3/4 micro-foam nitrile coating.

SKU	Description	Size	UOM	Price
MSG6897	Black nylon shell with black 3/4 micro-foam nitrile	S-L	DZ	\$26.26
MSG6897XL	Black nylon shell with black 3/4 micro-foam nitrile	XL	DZ	\$26.26



### C. Cor-Touch Foam™ Nylon Gloves with Nitrile Coating

The Cor-Touch Foam™ gloves are available gray, 13-gauge, nylon shell with black, foam nitrile coating. They are made with FDA accepted materials for food contact applications.

SKU	Description	Size	UOM	Price
MSG6893	Nylon gloves gray color shell with black foam nitrile coating	S-L	DZ	\$23.51
MSG6893XL	Nylon gloves gray color shell with black foam nitrile coating	XL	DZ	\$23.52

### D. Cor-Brite High Visibility String Polyurethane Coated Palms

The Cor-Brite is constructed of a 13-gauge, high visibility lime green polyester shell with a high visibility orange polyurethane palm coating.

SKU	Description	Size	UOM	Price
MSG6901	String knit glove high-vis lime with high vis orange polyurethane palms	XS-L	DZ	\$14.25
MSG6901XL	String knit glove high-vis lime with high vis orange polyurethane palms	XL	DZ	\$14.25
MSG69012X	String knit glove high-vis lime with high vis orange polyurethane palms	2X	DZ	\$14.25



### E. Cor-Brite High Visibility String Polyurethane Coated Palms

The Cor-Brite is constructed of a 13-gauge, high visibility lime green polyester shell with a high visibility yellow polyurethane palm coating.

SKU	Description	Size	UOM	Price
MSG6902	String knit glove high-vis lime with high vis yellow polyurethane palms	S-XL	DZ	\$14.26



### A. HyFlex® 11-801 Glove Black Foam Nitrile Glove

Offering the same outstanding light oil grip as HyFlex Foam 11-800, the new HyFlex Foam 11-801 provides exceptional comfort using Ansell's patented Knitted Variable Stitch Design. Its foam nitrile coating reduces hand fatigue and promotes maximum dexterity, while its gray colored knit liner stays clean longer, making these gloves more industrial friendly. ANSI/ISEA 105 - Cut Level 1, EN 388 - Cut Level 1

SKU	Description	Size	UOM	Price
ANS11-801	HyFlex foamed nitrile	6-11	DZ	\$36.85



### B. HyFlex® 11-800 Gray Foam Nitrile Glove

Knit-lined, dipped, color-coded cuff HyFlex foam glove provides your workers with the highest level of comfort and protection. The foam coating is resistant to snags and abrasions, and it provides excellent grip in light oil applications by channelling the oil away from the glove surface. Ideal for automotive assembly and small parts handling. ANSI/ISEA 105 - Cut Level 1, EN 388 - Cut Level 1

SKU	Description	Size	UOM	Price
ANS11-800	HyFlex glove	6-11	DZ	\$48.40

### C. HyFlex® 11-600 Lite Glove

Where dexterity is the key factor, light duty, coated, multi-purpose, palm coated, white polyurethane, knitwrist, safety without sacrificing performance. ANSI/ISEA 105 - Cut Level 1, EN 388 - Cut Level 1

SKU	Description	Size	UOM	Price
ANS11-600	HyFlex Lite fine	6-11	DZ	\$33.26



### D. HyFlex® 11-920 Glove with Ansell Grip Technology™

In oily, slippery conditions, the HyFlex® 11-920 glove provides optimal control along with durable protection. Our patent-pending Ansell Grip Technology™ coating channels fluid away from the glove's surface, enabling workers to effectively grip wet or moderately oily objects with less force. The blue nitrile coating provides high abrasion resistance and prevents oil penetration, reducing the risk of dermatitis and liquid exposure. Ultimately, hand fatigue is reduced for increased comfort and productivity. ANSI/ISEA 105 - Cut Level 1, EN 388 - Cut Level 1

SKU	Description	Size	UOM	Price
ANS11-920	HyFlex blue nitrile	6-11	DZ	\$49.89



### A. Standard Grain Cowhide Driver/Straight Thumb

Grain cow leather gloves are smooth, attractive, comfortable and durable. Offer better dexterity and sense of touch. Gloves are unlined and feature straight thumb and shirred elastic back.

SKU	Description	Size	UOM	Price
MSG8201	Standard grain cowhide driver, unlined, straight thumb	S-L	DZ	\$60.54
MSG8201XL	Standard grain cowhide driver, unlined, straight thumb	XL	DZ	\$64.47
MSG8201XXL	Standard grain cowhide driver, unlined, straight thumb	2XL	DZ	\$67.11

### B. Standard Grain Cowhide Driver/Keystone Thumb

Grain cow leather gloves are smooth, attractive, comfortable and durable. Offer better dexterity and sense of touch. Gloves are unlined and feature keystone thumb and shirred elastic back.

SKU	Description	Size	UOM	Price
MSG8210	Standard grain cowhide driver, keystone thumb	S - L	DZ	\$68.69
MSG8210XL	Standard grain cowhide driver, keystone thumb	XL	DZ	\$64.88
MSG82102X	Standard grain cowhide driver, keystone thumb	2X	DZ	\$67.55
MSG82103X	Standard grain cowhide driver, keystone thumb	3X	DZ	\$78.30



### C. Select Grain Cowhide Driver/Wing Thumb

Made of select grain cow these gloves are unlined and have a seamless forefinger. They feature a wing thumb.

SKU	Description	Size	UOM	Price
MSG1200	Select grain cowhide driver, unlined, wing thumb	XS - L	DZ	\$79.76
MSG1200XL	Select grain cowhide driver, unlined, wing thumb	XL	DZ	\$82.89

### D. Split Back, Grain Palm Cowhide Driver

Made with grain cowhide leather with a gray split leather back and features a slip on cuff with a shirred elastic back. Keystone thumb. Unlined.

SKU	Description	Size	UOM	Price
MSG8230	Split back, grain palm cowhide, keystone thumb	S-L	DZ	\$61.05
MSG8230XL	Split back, grain palm cowhide, keystone thumb	XL	DZ	\$61.05





### A. Split Cowhide Driver

These select split cow leather gloves are unlined and feature a keystone thumb and shirred elastic back. Available in gray or russet colors.

SKU	Description	Size	UOM	Price
MSG7800L	Russet split cowhide driver, keystone thumb	L	DZ	\$35.84
MSG7800XL	Russet split cowhide driver, keystone thumb	XL	DZ	\$37.46



### B. Grain Pigskin Driver

This driver's glove is made with pigskin, a more porous leather for greater breath ability. Pigskin will retain its softness even after becoming wet. Available in a keystone thumb with shirred elastic back. Available in premium grade and regular grade. Unlined.

SKU	Description	Size	UOM	Price
MSG8800	Economy grain pigskin driver, straight thumb	S-L	DZ	\$62.18
MSG8800XL	Economy grain pigskin driver, straight thumb	XL	DZ	\$62.19
MSG8810	Economy grain pigskin driver, keystone thumb	S-L	DZ	\$63.79
MSG8810XL	Economy grain pigskin driver, keystone thumb	XL	DZ	\$63.80
MSG8820	Premium grain pigskin driver, keystone thumb	M-L	DZ	\$70.16
MSG8820XL	Premium grain pigskin driver, keystone thumb	XL	DZ	\$70.16

### C. Premium Grain Goatskin Driver Gloves

Grain goat leather gloves are unlined and feature keystone thumb and shirred elastic back. Goatskin is preferred where tactile sensitivity is required. Goat provides excellent tensile strength and abrasion resistance. The high lanolin content makes it one of the softest leathers available.

SKU	Description	Size	UOM	Price
MSG8500	Premium grain goatskin driver's gloves, Keystone thumb	S-L	DZ	\$76.54
MSG8500XL	Premium grain goatskin driver's gloves, Keystone thumb	XL	DZ	\$79.75

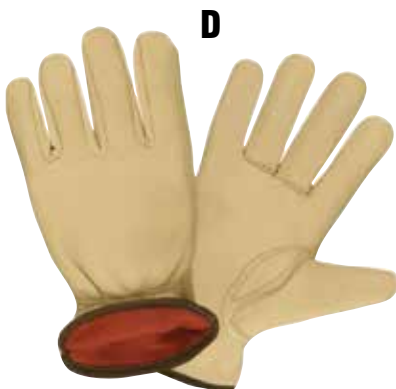

### D. Premium Grain Cowhide Driver/Red Fleece Lined

This full leather driver's glove is made with select leather for abrasion resistance red fleece lined for warmth and comfort. Other features include shirred elastic back and keystone thumb.

SKU	Description	Size	UOM	Price
MSG8240	Premium grain cowhide, red fleece lined, keystone thumb	S-L	DZ	\$100.46
MSG8240XL	Premium grain cowhide, red fleece lined, keystone thumb	XL	DZ	\$105.21
MSG8240XXL	Premium grain cowhide, red fleece lined, keystone thumb	2X	DZ	\$110.04



# Hand Protection

## Leather Hi Vis Driver



### A. Standard Grain Cowhide With Hi-Vis Finger Tips

Standard grain cowhide drivers, unlined, shirred elastic back, keystone thumb and hi-vi orange fingertips.

SKU	Description	Size	UOM	Price
MSG8211HV	Standard Grain Cowhide With Hi-Vis Finger Tips	S-L	DZ	\$74.93
MSG8211HVXL	Standard Grain Cowhide With Hi-Vis Finger Tips	XL	DZ	\$78.14
MSG8211HV2X	Standard Grain Cowhide With Hi-Vis Finger Tips	2X	DZ	\$81.28



### B. Select Grain Hi-Vis Cowhide Driver Gloves With Logo

Select grain cowhide leather driver glove. Extra protection by keeping safety in mind with Hi-Vis orange at the fingertips and a Hi-Vis reminder to "WATCH YOUR HANDS". Keystone thumb is durable and allows for the best flexibility. Shirred elastic wrist and welted seams on middle fingers.

SKU	Description	Size	UOM	Price
WCHE990KOT	Select Grain Cowhide Driver Gloves, Keystone Thumb, Hi-Vis	XS-XL	DZ	\$89.44
WCHE990KOT2X	Select Grain Cowhide Driver Gloves, Keystone Thumb, Hi-Vis	2X	DZ	\$99.21
WCHE990KOT3X	Select Grain Cowhide Driver Gloves, Keystone Thumb, Hi-Vis	3X	DZ	\$99.21



### C. Premium Grain Hi Vis Pigskin Driver

Premium grain pig leather driver that is unlined and has a keystone thumb. Features a hi-vis orange back and lime green 1.5" reflective tape.

SKU	Description	Size	UOM	Price
MSGF8821	Premium Grain Hi Vis Pigskin Driver	M-L	DZ	\$65.32
MSGF8821XL	Premium Grain Hi Vis Pigskin Driver	XL	DZ	\$66.94

### D. Thinsulate® Lined, Hi Vis Grain Pigskin Leather Palm W/ Knit Wrist

Made with a premium grain pig leather palm and Thinsulate lined. Features a hi vis orange back, 1-1/2" lime green reflective tape and a knit wrist.

SKU	Description	Size	UOM	Price
MSGF8760L	Hi Vis Grain Pigskin Leather Palm, Thinsulate lined, Knit Wrist	L	DZ	\$98.84
MSGF8760XL	Hi Vis Grain Pigskin Leather Palm, Thinsulate lined, Knit Wrist	XL	DZ	\$100.45





### A. Split Cowhide Leather Palm

These split cow leather work gloves feature a gunn cut pattern, knuckle strap, and 2-1/2" rubberized safety cuff.

SKU	Description	Size	UOM	Price
MSG7300RM	Premium leather palm gloves, 2 1/2" rubberized safety cuff	M	DZ	\$32.65
MSG7300RL	Premium leather palm gloves, 2 1/2" rubberized safety cuff	L	DZ	\$30.15
MSG7300RXL	Premium leather palm gloves, 2 1/2" rubberized safety cuff	XL	DZ	\$32.47
MSG7250RS	Select shoulder leather palm, 2 1/2" rubberized safety cuff	S	DZ	\$29.48
MSG7250R	Select shoulder leather palm, 2 1/2" rubberized safety cuff	L	DZ	\$29.48
MSG7200RS	Shoulder leather palm gloves, 2-1/2" rubberized Safety Cuff	S	DZ	\$25.45
MSG7200RM	Shoulder leather palm gloves, 2-1/2" rubberized Safety Cuff	M	DZ	\$25.45
MSG7200RL	Shoulder leather palm gloves, 2-1/2" rubberized Safety Cuff	L	DZ	\$27.06
MSG7200RXL	Shoulder leather palm gloves, 2-1/2" rubberized Safety Cuff	XL	DZ	\$27.06
MSG7200R2X	Shoulder leather palm gloves, 2-1/2" rubberized Safety Cuff	2X	DZ	\$30.29
MSG7200SM	Shoulder leather palm gloves, 2 1/2" starched Safety Cuff	M	DZ	\$22.23
MSG7200S	Shoulder leather palm gloves, 2 1/2" starched Safety Cuff	L	DZ	\$22.23



### B. Split Cowhide Leather Palm/Thinsulate® Lined

Thinsulate lined leather palm glove with a gunn cut pattern and a 2-1/2" rubberized safety cuff.

SKU	Description	Size	UOM	Price
MSG7270L	Split leather palms, Thinsulate lined, 2 1/2" safety cuff	L	DZ	\$66.94

### C. Select Split Cowhide Leather Palm/Knit Wrist

Made of shoulder split cow leather. Knit wrist with knuckle strap. General purpose applications requiring abrasion protection and breath ability. Applications include but not limited to: assembly, construction, fabricating, landscaping, maintenance, metal working, mining and sanitation.

SKU	Description	Size	UOM	Price
MSG7140L	Shoulder split cow leather palm gloves, knit wrist	L	DZ	\$24.24





### A. Split Cowhide Double Palm

Leather gloves are best suited for heavy material handling and general work purpose. This glove features a shoulder split cowhide leather double palm, striped canvas back, gunn cut pattern, knuckle strap and 2-1/2" rubberized safety cuff.

SKU	Description	Size	UOM	Price
MSG7261	Select Shoulder Leather Palm, 2-1/2" Rubberized Safety Cuff	M-XL	DZ	\$34.23
MSG7264	Select Shoulder Leather Palm, 4" Rubberized Gauntlet Cuff	L	DZ	\$37.46
MSG7261JP	Select Shoulder Leather Joint Palm, Rubberized Safety Cuff	L	DZ	\$26.94
MSG7261JPXL	Select Shoulder Leather Joint Palm, Rubberized Safety Cuff	XL	DZ	\$29.48
MSG7261JP2X	Select Shoulder Leather Joint Palm, Rubberized Safety Cuff	2X	DZ	\$33.43

### B. Split Cowhide Leather Patch Palm

Leather gloves are best suited for heavy material handling and general work purpose. Shoulder split cow leather patch palm glove with striped canvas back, gunn cut pattern, and 2-1/2" striped or denim safety cuff. Application examples: construction, maintenance, warehousing, assembly, fabricating, and general purpose.

SKU	Description	Size	UOM	Price
MSG7210	Split cow leather patch palm gloves, 2 1/2" Starched Safety Cuff	L	DZ	\$20.43
MSG7220	Split cow leather patch palm gloves, 2 1/2" Denim Safety Cuff	L	DZ	\$20.54



### C. Side Split Cowhide Leather Palm

Kevlar sewn gloves made of side split cow leather. Features include a gunn cut pattern, a knuckle strap and a 2-1/2" rubberized safety cuff.

SKU	Description	Size	UOM	Price
MSG1030	Side split leather palm gloves, 2 1/2" rubberized safety cuff	L	DZ	\$37.05

### D. Premium Grain Cowhide Leather Palm

Glove features fully wrapped premium leather index fingers and thumbs, leather fingertips, leather knuckle straps, wing thumb design and shirred elastic back. Choose 2-1/2" safety cuff or 4" gauntlet cuff.

SKU	Description	Size	UOM	Price
MSG8300	Premium grain cow leather palm glove, 2 1/2" Rubberized Safety Cuff	S-L	DZ	\$71.77
MSG8300XL	Premium grain cow leather palm glove, 2 1/2" Rubberized Safety Cuff	XL	DZ	\$74.92







### A. Shoulder Split Cowhide

Shoulder split cowhide provides excellent protection in high heat welding conditions at an affordable price. 14" length protects hands and arms from sparks and spatter. Weltd fingers to protect seams from sparks, wing thumb for a natural fit and cotton lining keeps hands cool.

SKU	Description	Size	UOM	Price
WCHE9010L	Welding Glove Shoulder Split Cowhide, Gray	L	DZ	\$69.91



**B**

### B. Shoulder Split Cowhide

Shoulder split cowhide provides excellent protection in high heat welding conditions at an affordable price. 14" length protects hands and arms from sparks and spatter. Weltd fingers to protect seams from sparks, wing thumb for a natural fit and cotton lining keeps hands cool.

SKU	Description	Size	UOM	Price
WCHE9011L	Welding Glove Shoulder Split Cowhide, Russet	L	DZ	\$87.68

### C. Premium Side Split Cowhide

Premium side split cowhide provides the most durable protection in high heat welding conditions. 14" length protects hands and arms from sparks and spatter. Weltd fingers and Kevlar® thread protect seams from sparks, wing thumb for a natural fit and cotton lining keeps hands cool.

SKU	Description	Size	UOM	Price
WCHE9030L	Welding Gloves Premium Side Split Cowhide	L	DZ	\$109.75



**C**



**D**

### D. Insulated Premium Side Split Cowhide - Dbl Reinforced Thumb

Premium side split cowhide provides the most durable protection in high heat welding conditions. 14" length protects hands and arms from sparks and spatter. Additional layer of foam on palm and back of hand provides added heat insulation. Double reinforced thumb combines thumb strap with an added patch on thumb saddle to protect high stress area. Double reinforced wing thumb provides a natural fit and reduces abrasion. Weltd fingers and Kevlar® thread protect seams from sparks.

SKU	Description	Size	UOM	Price
WCHE9051	Welding Gloves Insulated Premium Side Split Cowhide, Reinf Thumb	M-XL	DZ	\$128.50



**A**

### A. Heavyweight Top Grain Cowhide - MIG

Heavyweight grain cowhide glove provides a sturdy glove for all-around MIG welding. Unlined for additional dexterity. 4" cuff protects hands and lower arms from burns. Kevlar® thread protects seams from sparks. Wing thumb and seamless forefinger for increased dexterity.

SKU	Description	Size	UOM	Price
WCHE6010	Welding Gloves Heavyweight Top Grain Cowhide, MIG	S-XL	DZ	\$112.29

### B. Insulated Top Grain Pigskin - MIG

Grain pigskin glove provides a pliable and sturdy glove for MIG welding. Additional foam lining on back of hand protects against heat while reinforced straight thumb minimizes abrasion. 4" cuff protects hands and lower arms from burns. Kevlar® thread protects seams from sparks. Pigskin is ideal for wet and oily conditions.

SKU	Description	Size	UOM	Price
WCHE6020	Welding Gloves Insulated Top Grain Pigskin, MIG	M-L	PR	\$13.02



**B**



**C**

### C. Premium Grain Cow MIG/TIG Welder's Gloves

Top of the line welder's gloves feature premium grade cowhide leather sewn with Kevlar® thread for improved durability. 4" split leather gauntlet cuff protects wrist and forearm.

SKU	Description	Size	UOM	Price
MSG8130	Premium grain leather MIG/TIG welding glove	M-L	DZ	\$95.71
MSG8130XL	Premium grain leather MIG/TIG welding glove	XL	DZ	\$98.84
MSG81302XL	Premium grain leather MIG/TIG welding glove	2X	DZ	\$103.68

### D. Premium Goatskin MIG/TIG Welder's Gloves

Premium grain MIG/TIG welding glove goatskin leather Kevlar® sewn with wing thumb and blue split leather gauntlet cuff.

SKU	Description	Size	UOM	Price
MSG8530	Premium goatskin MIG/TIG welding glove	M-L	DZ	\$90.87
MSG8530XL	Premium goatskin MIG/TIG welding glove	XL	DZ	\$94.90



**D**



### A. Hi Vis Cotton Canvas Gloves with PVC Dots

Hi-vis canvas gloves with black PVC dots. Features a knit wrist.

SKU	Description	Color	UOM	Price
MSG2710	Hi vis canvas gloves with black PVC dots	Orange	DZ	\$11.90
MSG2715	Hi vis canvas gloves with black PVC dots	Lime Green	DZ	\$11.03



### B. Hi Vis Corded Cotton Canvas Double Palm Gloves

Made of 100% cotton, corded canvas. Features double palms and knit wrist. Heavy-weight.

SKU	Description	Color	UOM	Price
MSG2840CD	100% cotton, hi-vis corded double palm gloves, knit wrist	Orange	DZ	\$18.28
MSG2850CD	100% cotton, hi-vis corded double palm gloves, knit wrist	Lime green	DZ	\$18.28



### C. Cotton Canvas Gloves with Hi Vis PVC Dots

Cotton canvas gloves with high vis orange PVC dots. Features a clute cut, a straight thumb and knit wrist.

SKU	Description	Size	UOM	Price
MSG2650	12 oz Cotton Canvas Gloves, Knit Wrist, Hi Vis PVC Dots	L	DZ	\$9.42
MSG2670	10 oz Cotton Canvas Gloves, Knit Wrist, Hi Vis PVC Dots	L	DZ	\$9.26



MSG24101

### D. Cotton Canvas Double Palm Gloves

Cotton canvas gloves are primarily used for comfort and breath ability in general purpose applications. Glove features canvas double palm/nap in or nap out and clute cut. Knit wrist promotes warmth, fit, and helps prevent common particles from entering the glove.

SKU	Description	Size	UOM	Price
MSG24101	Cotton canvas gloves w/double palm/nap out/red knit wrist	L	DZ	\$13.69
MSG2430	Cotton canvas gloves w/double palm/nap out/knit wrist	L	DZ	\$13.37



### E. Brown Jersey Gloves

This standard weight glove is clute cut and constructed of a soft, jersey material. It provides optimum dexterity without compromising comfort and protection. The brown jersey glove features knit wrists and is available in men's and ladies sizes.

SKU	Description	Size	UOM	Price
MSG1400P	Standard weight, brown color jersey gloves, clute cut, knit wrist	L	DZ	\$5.96



# Hand Protection

## String Knit



### A. Gray Poly/Cotton String Knit Gloves

Uncoated string knit gloves feature 60% cotton/40% polyester fiber content. Used in general maintenance and other dry jobs. Glove is reversible.

SKU	Description	Size	UOM	Price
MSG3415G	Standard weight, gray color, string knit gloves	S-L	DZ	\$3.25

### B. Multi-Purpose String Knit Gloves

Multi-Purpose string knit gloves, natural color in standard, economy or medium weight. These gloves come in either a cotton/poly blend or you can get them made of 100% cotton. Provides comfort and warmth and allows manual dexterity.

SKU	Description	Size	UOM	Price
MSG3410	Standard weight, natural color, poly/cotton string knit gloves	S-L	DZ	\$3.18
MSG3411L	Economy weight, natural color, poly/cotton string knit gloves	L	DZ	\$3.25



### C. String Knit Gloves with PVC Dots

7 Gauge, string knit gloves feature 60% cotton/40% polyester fiber content and are PVC dotted. Ideal for general maintenance and other dry jobs.

SKU	Description	Size	UOM	Price
MSG3805S	Standard weight, string knit gloves, PVC Dots, 1 side	S	DZ	\$7.49
MSG3805L	Standard weight, string knit gloves, PVC Dots, 1 side	L	DZ	\$7.49
MSG3855S	Medium weight string knit gloves, PVC Dots on 2 sides	S	DZ	\$6.52
MSG3855L	Medium weight string knit gloves, PVC Dots on 2 sides	L	DZ	\$6.52
MSG3855XL	Medium weight string knit gloves, PVC Dots on 2 sides	XL	DZ	\$6.92

### D. Grey String Knit Gloves with PVC Dots

7 Gauge, grey string knit gloves feature cotton/polyester fiber content and are PVC dotted. Ideal for general maintenance and other dry jobs.

SKU	Description	Size	UOM	Price
MSG3855GS	Grey String Knit Gloves with PVC Dots	S	DZ	\$6.12
MSG3855GL	Grey String Knit Gloves with PVC Dots	L	DZ	\$6.12



### E. Thermal Liner Gloves

Insulating Liner Glove. Unique glove is manufactured with special fibers to trap warm air near the skin while wicking moisture away. It can be used as a liner or on it's own. Machine washable and shrink-resistant.

SKU	Description	UOM	Price
MSGFBC3730	White Thermostat® Liner	DZ	\$26.58
MSGFBC3830	Blue Thermostat® Liner	DZ	\$31.53
MSGH3677	Black Thermal Liner, Acrylic/Spandex	DZ	\$13.37



**A. PVC Dipped Gloves**

Made of 100% Poly Vinyl Chloride (PVC). Features an interlock lined construction.

SKU	Description	Finish	Length	Size	UOM	Price
MSG5012	PVC dipped gloves	Smooth	12"	XL	DZ	\$17.48
MSG5012R	PVC dipped gloves	Rough	12"	XL	DZ	\$18.69
MSG5014	PVC dipped gloves	Smooth	14"	XL	DZ	\$19.49
MSG5014R	PVC dipped gloves	Rough	14"	XL	DZ	\$20.70



**B. Premium Nitrile Fully Coated Gloves**

Premium nitrile fully coated glove with smooth finish. This glove has a jersey shell, 2-1/2" safety cuff and is ActiFresh® treated.

SKU	Description	Size	UOM	Price
MSG6961L	Premium nitrile fully coated gloves, smooth finish, jersey lined, safety cuff	L	DZ	\$32.62
MSG6961RL	Premium nitrile fully coated gloves, rough finish, jersey lined, safety cuff	L	DZ	\$38.26



**C. Sol-Vex®**

Sol-Vex gloves are made of a high-performance nitrile compound which provides an outstanding combination of strength and chemical resistance. When exposed to aromatic and petroleum solvents, as well as caustics and animal fats, Sol-Vex gloves have proven to be a superior choice over rubber or neoprene. Sol-Vex gloves won't swell, weaken or degrade, and they offer better protection against snags, punctures, abrasions and cuts. And, as added benefits, Sol-Vex gloves do not promote contact dermatitis, and their component materials comply with FDA regulations for food contact.

SKU	Description	Thickness	Length	Size	UOM	Price
ANS37175-6	Sol-Vex embossed, flock-lined gloves	15 mil	13"	6	DZ	\$19.80
ANS37175-7	Sol-Vex embossed, flock-lined gloves	15 mil	13"	7	DZ	\$19.80
ANS37175-8	Sol-Vex embossed, flock-lined gloves	15 mil	13"	8	DZ	\$19.80
ANS37175-9	Sol-Vex embossed, flock-lined gloves	15 mil	13"	9	DZ	\$19.80
ANS37175-10	Sol-Vex embossed, flock-lined gloves	15 mil	13"	10	DZ	\$19.80
ANS37175-11	Sol-Vex embossed, flock-lined gloves	15 mil	13"	11	DZ	\$19.80
ANS37185-7	Sol-Vex embossed gloves	22 mil	18"	7	DZ	\$109.00
ANS37185-8	Sol-Vex embossed gloves	22 mil	18"	8	DZ	\$109.00
ANS37185-9	Sol-Vex embossed gloves	22 mil	18"	9	DZ	\$109.00
ANS37185-10	Sol-Vex embossed gloves	22 mil	18"	10	DZ	\$109.00
ANS37185-11	Sol-Vex embossed gloves	22 mil	18"	11	DZ	\$109.00

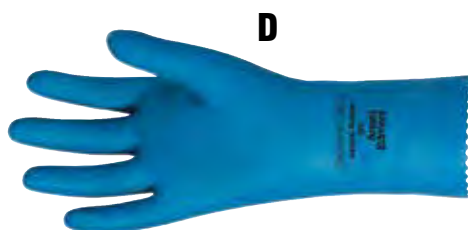

**D. Natural Blue™**

Natural Blue gloves are 17 mil thick for superior tactile sensitivity and dexterity, as well as good chemical, snag, puncture, abrasion- and cut-resistance. Made with component materials that comply with FDA regulations for food contact, the gloves feature a patterned grip and a conspicuous blue color which is preferred by the poultry and food processing industries. 12" long.

SKU	Description	Size	UOM	Price
ANS356-	Natural Blue gloves	7-10	DZ	\$10.53

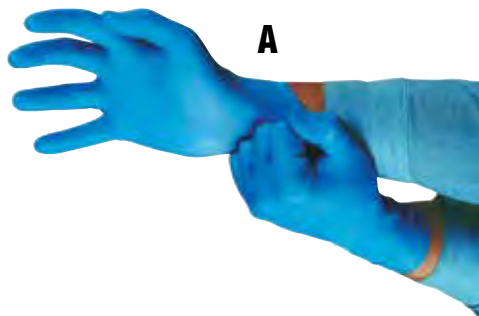

### A. TNT® Blue Thin Nitrile Gloves

Disposable nitrile gloves set a whole new standard in durability and chemical splash protection. Features textured finger tips for exceptional grip. Recommended for manufacturing, light-duty maintenance, automotive, intricate parts handling, laboratory analysis and technical work. Lightly powdered in a clean polybag. Superior flexibility, puncture resistance, made of 100% nitrile. The glove contains absolutely no fillers, additives, silicones or plasticizers. Rolled cuff gives additional cuff strength and protects the skin from chemicals running off the glove. Complies with FDA regulations for food contact.

SKU	Description	Thickness	Size	UOM	Price
ANS92575	TNT nitrile gloves lightly powdered	4 mil	S-L	100/BX	\$9.60
ANS92575XL	TNT nitrile gloves lightly powdered	4 mil	XL	100/BX	\$9.81

### B. Touch N Tuff®

Touch N Tuff disposable gloves set a whole new standard in comfort, durability, dexterity and cleanliness. Made of 100% nitrile, the gloves contain absolutely no fillers, silicones or plasticizers. Although they are only 4 mils thick, Touch N Tuff gloves provide three times the puncture resistance of competitive latex or vinyl gloves. 9.5 inches in length, they are available powdered or powder-free.

SKU	Description	Size	UOM	Price
ANS92600S	Touch-N-Tuff, powder free	S	100/BX	\$12.72
ANS92600M	Touch-N-Tuff, powder free	M	100/BX	\$12.72
ANS92600L	Touch-N-Tuff, powder free	L	100/BX	\$12.72
ANS92600XL	Touch-N-Tuff, powder free	XL	100/BX	\$12.72

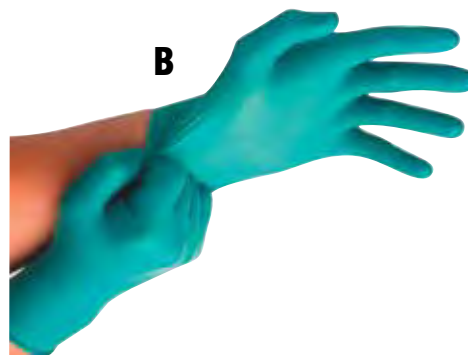

### C. Touch N Tuff®

Touch N Tuff 92-616 disposable gloves are made of 100% nitrile and offers three times the puncture resistance of standard latex or vinyl gloves. They give a high level of protection against hydrocarbons, fats, grease and alcohols and combines excellent fingertip sensitivity with exceptional durability. Lightweight and comfortable to wear, Touch N Tuff® gloves comply with FDA food handling requirements (21 CFR 177.2600)

SKU	Description	Size	UOM	Price
ANS92616	Touch-N-Tuff, powder free, textured finish, blue	S-XL	150/BX	\$11.79

### D. Barrier™

A major breakthrough in flat-film glove technology, Barrier gloves feature a unique non-woven liner that absorbs perspiration and makes the gloves comfortable to wear, especially for extended periods. In addition, the winged-thumb, hand-specific design provides greater dexterity. Proprietary seam-fusion technology provides a secure seal against chemicals and also assures a flexible, comfortable fit for greater dexterity and reduced hand fatigue.

SKU	Description	Thickness	Size	UOM	Price
ANS2-100-	Barrier flat film chemical resistant gloves	2.5 mil	6-11	PR	\$7.82







### A. Glove Guard® Clip

Glove Guard with a proven record of over ten years keeps gloves close at hand while keeping the worker safe with the patented break-away center. Made of engineered grade material that holds its memory and resists flex fatigue as well as being non-conductive and non-corrosive, its sleek design lies close to the body so as not to interfere with job activities.

SKU	Description	UOM	Price
GOFIN1939	Glove Guard Clip Granite with Medsafe logo	EA	\$4.85
GOFIN1939YL	Glove Guard Clip Yellow	EA	\$4.85



A

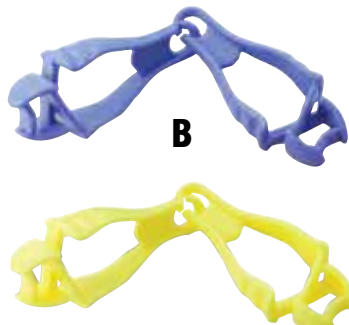

B

### B. Squids® Glove Grabber™

The Glove Grabber is a handy and cost effective device for improving worker safety by making it easier than ever to keep gloves within reach at all times. Using a patent-pending design that opens smoother and wider, the Glove Grabber holds gloves of every style and thickness and for virtually any application.

SKU	Description	UOM	Price
ERG3400Y	Squids Glove Grabber yellow	EA	\$2.60
ERG3400B	Squids Glove Grabber blue	EA	\$2.60

## SALISBURY

by Honeywell

### C. Canvas Glove Bags

Salisbury by Honeywell bags are constructed of heavy duty canvas duck and are double stitched at stress points for extra durability. Canvas bags feature a D-ring for hanging in trucks or on work belts. Bags feature tapered gussets with wide opening tops for easy insertion.

SKU	Description	Size	UOM	Price
SALGB114	Canvas glove bag, holds 14" glove	9" x 16"	EA	\$43.89
SALGB116	Canvas glove bag, holds 16" glove	9" X 18"	EA	\$48.21
SALGB118	Canvas glove bag, holds 18" glove	9" X 20"	EA	\$50.72

C



# Clothing



# Clothing

## Garment Selection

Applications	MicroMAX NS	Pyrolon CRFR	ChemMAX 1	ChemMAX 2
<b>Petro-Chemical</b>				
Turn Arouds	✓	✓	✓	✓
Solvent Manufacturing		✓	✓	✓
Aromatic Manufacturing	✓	✓	✓	✓
Equipment Maintenance	✓		✓	✓
Chemical Handling	✓	✓	✓	✓
<b>Automotive/Aviation/ Trains/Road/Ship-building</b>				
Paint Prep	✓			
Paint	✓			
Assembly	✓			
Fuel system maintenance		✓	✓	✓
Tank cleaning/service		✓	✓	✓
Material handling	✓	✓	✓	✓
<b>Agriculture</b>				
Spray ground	✓			
Overhead Spray	✓		✓	✓
<b>Power/Energy Plants</b>				
Ash Removal	✓	✓	✓	✓
Maintenance (Mech.)	✓	✓		
Maintenance (Elec.)		✓		
<b>Civil/Construction Engineering</b>				
Welding		✓		
Demolition	✓			
Ground Remediation	✓	✓		
<b>Food Processing</b>				
Packaging	✓			
Equipment Cleaning	✓		✓	✓
<b>Bio-logical Hazard Handling</b>				
Avian Flu Flock Remediation	✓			
Hazardous Material spill resp.		✓	✓	✓
Fiber glass handling	✓			
Industrial Demolition/Elimi- nation and ground Remediation		✓	✓	✓





**MicroMAX NS**

### A. MicroMax® NS

This line of general purpose protective clothing can be used in work environments where hazardous or non-hazardous contaminants may be present. Very economical and lightweight, MicroMAX® NS features high MVTR and is breathable for worker comfort. MicroMAX® NS is strong, wet or dry, perfect for work environments where dirt, grime, splashes and spills are present. Packaged 25 per case.

SKU	Description	Size	UOM	Price
MSCCTL412	MicroMAX NS coverall zip front	S-2X	25/CS	\$70.34
MSCCTL414	MicroMAX NS coverall zip front, attached hood and boots, elastic wrist	S-2X	25/CS	\$89.02
MSCCTL428	MicroMAX NS coverall zip front, attached hood, elastic wrist & ankles	S-2X	25/CS	\$93.68

### B. MicroMax®

MicroMAX® from Lakeland Industries brings the most advanced microporous technology to the protective clothing market yet. This line of general purpose protective clothing can be used in any non-hazardous environment where dirt, grime, splashes and spills are present. The MicroMAX® fabric is comprised of a microporous film with a nylon scrim between the film and substrate that gives the material additional strength. Tough can-do protection at a price that is sure to agree with your budget. Packaged 25 per case.

**B**



**MicroMAX**

SKU	Description	Size	UOM	Price
MSCTG412	MicroMAX coverall zip front	S-2X	25/CS	\$81.74
MSCTG4123X	MicroMAX coverall zip front	3X	25/CS	\$85.83
MSCTG4124X	MicroMAX coverall zip front	4X	25/CS	\$90.97
MSCTG414	MicroMAX coverall zip front, attached hood and boots, elastic wrist	S-2X	25/CS	\$109.14
MSCTG4143X	MicroMAX coverall zip front, attached hood and boots, elastic wrist	3X	25/CS	\$114.59
MSCTG4144X	MicroMAX coverall zip front, attached hood and boots, elastic wrist	4X	25/CS	\$121.47
MSCTG417	MicroMAX coverall zip front, elastic wrist & ankles	S-2X	25/CS	\$95.04
MSCTG4173X	MicroMAX coverall zip front, elastic wrist & ankles	3X	25/CS	\$99.78
MSCTG4174X	MicroMAX coverall zip front, elastic wrist & ankles	4X	25/CS	\$105.77
MSCTG428	MicroMAX coverall zip front, attached hood, elastic wrist & ankles	S-2X	25/CS	\$100.04
MSCTG4283X	MicroMAX coverall zip front, attached hood, elastic wrist & ankles	3X	25/CS	\$105.05
MSCTG4284X	MicroMAX coverall zip front, attached hood, elastic wrist & ankles	4X	25/CS	\$111.35

**C**



**MicroMAX NS**  
**COOL SUIT**

### C. MicroMax® NS Cool Suit

Like the MicroMAX® NS coverall, the MicroMAX NS Cool Suit™ protects against dirt, grease and spills but features increased breathability with an added spunbond polypropylene back panel. A superb pattern design and an elastic back waist offer improved comfort and fit. Front and sides made of microporous film on a polypropylene substrate provide barrier protection and a flap cover over the zipper protects against splashes. The breathable back panel offers only a light particulate barrier. Stay cool while protecting yourself with the MicroMAX NS Cool Suit™.

SKU	Description	Size	UOM	Price
MSCCOL412	MicroMAX NS Cool Suit coverall zip front	S-2X	25/CS	\$89.41
MSCCOL4123X	MicroMAX NS Cool Suit coverall zip front	3X	25/CS	\$99.92
MSCCOL4124X	MicroMAX NS Cool Suit coverall zip front	4X	25/CS	\$105.88
MSCCOL4125X	MicroMAX NS Cool Suit coverall zip front	5X	25/CS	\$113.88
MSCCOL428	MicroMAX NS Cool Suit coverall zip front w/hood & elastic wrist/ankles	S-2X	25/CS	\$107.14
MSCCOL4283X	MicroMAX NS Cool Suit coverall zip front w/hood & elastic wrist/ankles	3X	25/CS	\$143.46
MSCCOL4284X	MicroMAX NS Cool Suit coverall zip front w/hood & elastic wrist/ankles	4X	25/CS	\$152.03
MSCCOL4285X	MicroMAX NS Cool Suit coverall zip front w/hood & elastic wrist/ankles	5X	25/CS	\$163.47



A



### A. Pyrolon® Plus 2 Flame Resistant Coverall

Pyrolon® Plus 2 has been thermal mannequin tested according to ASTM F1930. When worn over thermally protective coveralls, garments made of Pyrolon® Plus 2 can reduce predicted body burn injury. Meets the requirements of NFPA 2113, Standard on Selection, Care, Use, and Maintenance of Flame-Resistant Garments for Protection of Industrial Personnel Against Flash Fire. It offers strength, wet or dry, over other traditional FR disposable garments. It is breathable, making this a cool and comfortable garment to wear.

SKU	Description	Seams	Color	Size	UOM	Price
MSC7412B	Tempro secondary FR coverall	Serged	Light blue	S-XL	25/CS	\$136.77
MSC7412B2X	Tempro secondary FR coverall	Serged	Light blue	2XL	25/CS	\$143.61
MSC7412B3X	Tempro secondary FR coverall	Serged	Light blue	3XL	25/CS	\$152.22
MSC7412B4X	Tempro secondary FR coverall	Serged	Light blue	4XL	25/CS	\$163.64

B



MSC51150

### B. Pyrolon® CRFR

Pyrolon® CRFR protective wear is unique. It's disposable, chemical resistant, and flame-resistant, meeting NFPA 2113 requirements. Imagine all these qualities in one protective garment. Pyrolon® CRFR garments bar contaminating flammables like paint, oil, and grease, hazardous liquids, dry particulates, and other harmful contaminants from penetrating to inner clothing.

SKU	Description	Size	UOM	Price
MSC51150	Pyrolon CRFR 2ml grey, attached hood, elastic wrist, and booties	S-XL	6/CS	\$234.57
MSC511502X	Pyrolon CRFR 2ml grey, attached hood, elastic wrist, and booties	2X	6/CS	\$246.27
MSC511503X	Pyrolon CRFR 2ml grey, attached hood, elastic wrist, and booties	3X	6/CS	\$258.10
MSC51250	Pyrolon CRFR 2ml grey jacket, collar, elastic wrist, and storm flap	S-XL	6/CS	\$201.07
MSC512502XL	Pyrolon CRFR 2ml grey jacket, collar, elastic wrist, and storm flap	2X	6/CS	\$211.15
MSC512503XL	Pyrolon CRFR 2ml grey jacket, collar, elastic wrist, and storm flap	3X	6/CS	\$221.69
MSC512504XL	Pyrolon CRFR 2ml grey jacket, collar, elastic wrist, and storm flap	4X	6/CS	\$232.78
MSC512505XL	Pyrolon CRFR 2ml grey jacket, collar, elastic wrist, and storm flap	5X	6/CS	\$244.41
MSC51300	Pyrolon CRFR 2ml grey pant, elastic waist and ankles	S-XL	6/CS	\$207.55
MSC513002XL	Pyrolon CRFR 2ml grey pant, elastic waist and ankles	2X	6/CS	\$217.92
MSC513003XL	Pyrolon CRFR 2ml grey pant, elastic waist and ankles	3X	6/CS	\$228.84
MSC513004XL	Pyrolon CRFR 2ml grey pant, elastic waist and ankles	4X	6/CS	\$240.25
MSC513005XL	Pyrolon CRFR 2ml grey pant, elastic waist and ankles	5X	6/CS	\$252.26

### C. ChemMax® 1

ChemMax® is constructed with a unique polyethylene barrier film and a continuous filament polypropylene nonwoven. ChemMax®1 garments bar many harmful contaminants from penetrating to inner clothing. ChemMax® fits the Lakeland standard at a price you can afford.

SKU	Description	Size	UOM	Price
MSCC5412	ChemMax®1 zipper front	S-XL	25/CS	\$117.31
MSCC54122X	ChemMax®1 zipper front	2X	25/CS	\$123.18
MSCC5414	ChemMax®1 zipper front, attached hood, boots, elastic wrists	S-XL	25/CS	\$148.86
MSCC54142X	ChemMax®1 zipper front, attached hood, boots, elastic wrists	2X	25/CS	\$156.30
MSCC5428	ChemMax®1 zipper front w/hood, elastic wrist and ankles	S-XL	25/CS	\$127.05
MSCC54282X	ChemMax®1 zipper front w/hood, elastic wrist and ankles	2X	25/CS	\$133.40

C





### A. ChemMax® 2

ChemMAX® 2 is the second level of barrier protection in the new ChemMAX® line of products from Lakeland Industries. ChemMax® 2 is a superior and economical chemical protective suit developed using the knowledge and expertise that you have come to expect from Lakeland. The unparalleled strength and softness of ChemMAX® 2' features Dow Saranex® 23P film on two layers of a unique bi-component spunbond nonwoven substrate and provides protection for chemical mixing and handling, environmental cleanup, hazardous materials remediation and response, pharmaceutical manufacturing, spray painting and general industry. ChemMAX® 2 is useful in protecting against hazardous chemicals and contaminants found in the work place.

SKU	Description	Size	UOM	Price
MSCC44412	ChemMax@2 zipper front	S-XL	12/CS	\$156.51
MSCC444122X	ChemMax@2 zipper front	2X	12/CS	\$164.34
MSCC44414	ChemMax@2 zipper front, attached hood, boots, elastic wrists	S-XL	12/CS	\$185.84
MSCC444142X	ChemMax@2 zipper front, attached hood, boots, elastic wrists	2X	12/CS	\$195.13
MSCC44428	ChemMax@2 zipper front w/hood, elastic wrist and ankles	S-XL	12/CS	\$171.18
MSCC444282X	ChemMax@2 zipper front w/hood, elastic wrist and ankles	2X	12/CS	\$179.74

### B. ChemMax® 3

ChemMax® 3 Ideal for the industrial environment as well as emergency responders and law enforcement, ChemMax® 3 uses the latest technology to produce a superior product. Durable and lightweight, ChemMax® 3 provides a barrier against a broad spectrum of toxic industrial chemicals, dual use chemicals, chemical warfare agents and other harmful contaminants. The multi-layer film is applied to a heavy polypropylene nonwoven for increased strength and durability. The barrier film is significantly softer than other products on the market, resulting in a quiet, more comfortable garment. Put your trust in a ChemMax® 3 garment and you will feel confident that you are doing your best to protect your team from the dangers lurking around them.

SKU	Description	Size	UOM	Price
MSCC3T130	ChemMax@3 Hood, elastic face, wrists and ankles	S-XL	6/CS	\$229.90
MSCC3T1302X	ChemMax@3 Hood, elastic face, wrists and ankles	2X	6/CS	\$241.42
MSCC3T150	ChemMax@3 Hood, elastic face, elastic wrists, attached boots	S-XL	6/CS	\$271.87
MSCC3T1502X	ChemMax@3 Hood, elastic face, elastic wrists, attached boots	2X	6/CS	\$285.47



### C. ChemMAX® 4

Heavy duty splash protection that is high in performance and comfort! This line of high performance chemical protection can be used in work environments where hazardous contaminants may be present. ChemMax® 4 is at the top of the ChemMax line of clothing. ChemMax® 4 features a 6 Layer protective barrier that will stand up to the toughest of hazardous chemical environments

SKU	Description	Color	Size	UOM	Price
MSC41130	ChemMax@4 with hood, elastic face, elastic wrists	Yellow	S-XL	6/CS	\$305.12
MSC411302X	ChemMax@4 with hood, elastic face, elastic wrists	Yellow	2XL	6/CS	\$320.37
MSC411303X	ChemMax@4 with hood, elastic face, elastic wrists	Yellow	3XL	6/CS	\$336.40
MSC411304X	ChemMax@4 with hood, elastic face, elastic wrists	Yellow	4XL	6/CS	\$353.21
MSC411305X	ChemMax@4 with hood, elastic face, elastic wrists	Yellow	5XL	6/CS	\$370.88





### A. DuPont™ Tyvek® Coveralls

Tyvek® Coveralls set the industry standard with the best balance of protection, durability and comfort. Ideal for applications when dry particulates and light liquid splashes are hazardous, including spray-painting, agriculture and lead remediation. Provides durable protection while remaining comfortable to workers. Packaged 25 per case.

SKU	Description	Size	UOM	Price
MSC1412	Basic coverall, zipper front	M-XL	25/CS	\$126.61
MSC14122X	Basic coverall, zipper front	2XL	25/CS	\$134.20
MSC14123X	Basic coverall, zipper front	3XL	25/CS	\$142.25
MSC14124X	Basic coverall, zipper front	4XL	25/CS	\$153.63
MSC1417	Elastic wrists/ankles, zipper front	M-XL	25/CS	\$143.07
MSC14172X	Elastic wrists/ankles, zipper front	2XL	25/CS	\$151.66
MSC14173X	Elastic wrists/ankles, zipper front	3XL	25/CS	\$160.76
MSC14174X	Elastic wrists/ankles, zipper front	4XL	25/CS	\$173.62
MSC1428	Elastic wrists/ankles with attached hood, zipper front	M-XL	25/CS	\$153.27
MSC14282X	Elastic wrists/ankles with attached hood, zipper front	2XL	25/CS	\$162.48
MSC14283X	Elastic wrists/ankles with attached hood, zipper front	3XL	25/CS	\$172.23
MSC14284X	Elastic wrists/ankles with attached hood, zipper front	4XL	25/CS	\$186.00
MSC1414	Elastic wrists with attached hood and boots, zipper front	M-XL	25/CS	\$155.54
MSC14142X	Elastic wrists with attached hood and boots, zipper front	2XL	25/CS	\$164.91
MSC14143X	Elastic wrists with attached hood and boots, zipper front	3XL	25/CS	\$174.79
MSC14144X	Elastic wrists with attached hood and boots, zipper front	4XL	25/CS	\$188.79



A



B

### B. DuPont™ Tyvek® Lab Coat

Tyvek® garments are composed of flash spun high density polyethylene which creates a unique, nonwoven material available only from DuPont. Tyvek® provides an ideal balance of protection, durability and comfort of any limited use fabric technology. Tyvek® fabric offers an inherent barrier to small size particles. Protection is built into the fabric itself; there are no films or laminates to abrade or wear away. Tyvek® fabric's durability advantage over microporous film fabrics delivers consistently better barrier, even after wear and abrasion. Applications include: lead and asbestos abatement/remediation, general maintenance/operations, spray painting, general clean-up.

SKU	Description	Color	Size	UOM	Price
MSC1140	Tyvek lab coat w/front snap closure, collar, serged seams	White	S-XL	30/CS	\$120.36
MSC11402X	Tyvek lab coat w/front snap closure, collar, serged seams	White	2XL	30/CS	\$127.59
MSC11403X	Tyvek lab coat w/front snap closure, collar, serged seams	White	3XL	30/CS	\$135.24

### C. DuPont™ Tyvek® Hood

Tyvek® garments are composed of flash spun high density polyethylene which creates a unique, nonwoven material available only from DuPont. Tyvek® provides an ideal balance of protection, durability and comfort of any limited use fabric technology. Tyvek® fabric offers an inherent barrier to small size particles. Protection is built into the fabric itself; there are no films or laminates to abrade or wear away. Tyvek® fabric's durability advantage over microporous film fabrics delivers consistently better barrier, even after wear and abrasion. Applications include: lead and asbestos abatement/remediation, general maintenance/operations, spray painting, general clean-up.

SKU	Description	Color	Length	UOM	Price
DPTY657S	Tyvek® Hood pullover 100/CS	White	Shoulder	CS	\$94.26



C



D

### D. DuPont™ Tyvek® Apron

Tyvek® garments are composed of flash spun high density polyethylene which creates a unique, nonwoven material available only from DuPont. Tyvek® provides an ideal balance of protection, durability and comfort of any limited use fabric technology. Tyvek® fabric offers an inherent barrier to small size particles. Protection is built into the fabric itself; there are no films or laminates to abrade or wear away. Tyvek® fabric's durability advantage over microporous film fabrics delivers consistently better barrier, even after wear and abrasion. Applications include: lead and asbestos abatement/remediation, general maintenance/operations, spray painting, general clean-up.

SKU	Description	Seams	Color	Length	UOM	Price
MSC601	Tyvek bib style apron	Serged	White	36"	100/CS	\$121.50





**A**

### A. 1.25 mm Polyethylene Apron

Apron provides economical protection, wear once and throw away. Made of 1.25 mm 100% white polyethylene construction with attached ties. Excellent flexibility and resistance to chemicals, oils, fats and grease.

SKU	Description	Material	Length	Color	UOM	Price
SZDAP1252442	1.25 mm disposable apron	Polyethylene	24" x 42"	White	100/PK	\$7.07



### B. HexArmor® Heavy Duty Cut Resistant Apron 24" X 30"

Made with SuperFabric® brand material for the highest cut-resistance available on the market- Exceeds ISEA/CE Level 5. Innovative industrial puncture protection on enhanced areas from wires, metal, wood, and glass. Double layer, lightweight compared to alternatives, launderable.

SKU	Description	UOM	Price
HEXAP322	Apron heavy duty 24" x 30" cut level 5	EA	\$208.79



**B**



**C**

### C. HexArmor® Heavy Duty Split Leg Cut Resistant Apron

Made with SuperFabric® brand material for the highest cut-resistance available on the market - Exceeds ISEA/CE Level 5. Innovative industrial puncture protection on enhanced areas from wires, metal, wood, and glass. Heavy Duty (double layer belly patch), lightweight compared to alternatives, launderable.

SKU	Description	UOM	Price
HEXAP361	Apron heavy duty split leg 36" cut level 5	EA	\$233.67



### D. CPP™ Heavy-Duty Aprons

These heavy-duty aprons offer a broad spectrum of protection. Neoprene styles are resistant to a wide range of chemicals. Hycar® (a tough nitrile blend) styles are ideal for cold conditions, and protects against grease and animal fats. Urethane styles offer lightweight comfort and long wear. Available in a variety of weights and colors. Ideal applications include, meat packing, chemical processing, industrial maintenance and food processing

SKU	Description	Color	Size	UOM	Price
ANS56402	Lightweight neoprene	Black	35" x 45"	EA	\$13.07



**D**

## A. CPP™ Shop Apron, Denim

All-cotton shop apron features coolness, comfort, versatility and launderability. Made from high-quality, heavy-duty, 14-ounce pre-shrunk denim. Applications include industrial maintenance, construction and manufacturing operations.

SKU	Description	Style Pockets	Size	UOM	Price
ANS57003	CPP shop apron, denim	Two-compartment bib pocket	28" x 36"	EA	\$5.21
ANS57004	CPP shop apron, denim	Bib pocket, side pocket	28" x 36"	EA	\$5.47



B

## B. CPP™ Vinyl Apron

Priced for disposal. Apron shields front of body and clothing. Made of the highest-quality virgin vinyl. The die cut incorporates neck straps and tie straps as a one-piece vinyl design.

SKU	Description	Color	Size	UOM	Price
ANS56009-45	CPP Vinyl apron, 6 mil	Blue	35" x 45"	DZ	\$17.68

## C. CPP™ Heavy-Duty Apron, Medium Weight, Hycar

Durable thick coating of Hycar® (a tough nitrile blend) on the outside makes this apron ideal for use in both cold and warm environments.

SKU	Description	Material	Color	Size	UOM	Price
ANS56512-45	CPP Heavy-duty apron, Heavyweight, 18 oz.	Hycar	Black	35" x 45"	EA	\$16.09



C



D

## D. CPP™ PVC Apron, Heavy Duty

Wearing barrier protection in food handling and food service establishments is important in minimizing the spread of bacteria and protecting consumers. This heavy-duty apron shields the front of both body and clothing. Premium sewn-edge style provides superior flexibility and resistance to chemicals, fats, oils, grease, punctures and abrasions. Heat-sealed vinyl grommets for greater strength and longer life. Component materials comply with FDA regulations for food contact use. Applications include sanitation/maintenance; light-duty food safety/protection.

SKU	Description	Material	Thickness	Color	Size	UOM	Price
ANS56100-45	PVC apron, heavyduty	PVC	20 mil	Green	35" x 45"	EA	\$5.12
ANS56100-50	PVC apron, heavyduty	PVC	20 mil	Green	35" x 50"	EA	\$5.51





**A**



**A. Cane Mesh Protective Sleeves**

The 59-801 black cane mesh sleeve has superior flexibility and excellent resistance to punctures, snags and abrasions. This cane mesh sleeve, the 59-801, are 1,200 grams (+/- 200) using ASTM F 1790. This makes the sleeve **ANSI Cut Level 3** rated.

SKU	Description	UOM	Price
ANS59801-9	Cane mesh sleeves	PR	\$8.25

**B. Protective Sleeves, Vinyl, 8 mil**

Low-cost arm protection against chemicals and liquid splash. Vinyl style is completely heat-sealed with no exposed elastic. Sleeves provide added arm and garment protection above the reach of gloves. Applications include beef, pork and chicken processing; meat packing; light duty food sanitation/protection; and sanitation/maintenance. Component materials comply with FDA regulations for food contact.

SKU	Description	Material	Color	Size	UOM	Price
ANSVSB8HS	Protective vinyl sleeves, 8 mil	Vinyl	Blue/White/Clear	18"	DZ	\$16.00

**B**



**C**



**C. Cut Resistant Sleeves Made With DuPont™ Kevlar®**

100% Kevlar® brand fiber, 2-ply, string knit sleeve is cut- and heat-resistant. Fabric provides high strength with light weight comfort and protection.

SKU	Description	Style	Length	UOM	Price
MSG3014T	100% Kevlar, cut-resistant sleeves	Thumb slot	14"	EA	\$3.06
MSG3014E	100% Kevlar, cut-resistant sleeves	No thumb slot	14"	EA	\$2.11
MSG3018TE	100% Kevlar, cut-resistant sleeves	Thumb slot	18"	EA	\$3.04
MSG3018E	100% Kevlar, cut-resistant sleeves	No thumb slot	18"	EA	\$2.84

**D**



**D. Terry Sleeve**

Standard weight, loop-out terry sleeve, 18-inch length

SKU	Description	UOM	Price
MSG3258	Terry sleeve 18" standard weight	EA	\$.84



**E**



**E. Flame Resistant Cotton Duck Sleeve**

These flame resistant sleeves are made from 9.5 oz cotton duck fabric. Excellent for warm weather or indoor use, it is 18" in length and has a 2½" elastic closure at the top and wrist. Color is visual green.

SKU	Description	Material	Color	Size	UOM	Price
STGWC871-18A	Sleeve 9.5 oz FR	Cotton Duck	Green	18"	PR	\$10.26



**A. Tyvek® Sleeve**

Sleeve has serged seams, elastic top and elastic wrist. Made out of Tyvek®, providing the best balance of protection, durability and comfort; an inherent barrier protection against dry particulate hazards. Even after abrasion, stops micro porous particles better than other reusable garments. Wide application range including, general maintenance/operations, agriculture, spray painting, food processing, lead abatement, mold remediation, environmental cleanup, silica and asbestos abatement. Warning: Tyvek® should not be used around heat, flames, sparks or in potentially flammable or explosive environments.

SKU	Description	Seams	Color	Length	UOM	Price
MSC850	Tyvek sleeve	Serged	White	18"	100 PR/CS	\$80.61



**B. Hot Not Sleeves**

Hot Not heat-resistant sleeves allow you to work around and handle hot engines, machinery, ovens and most any hot industrial process without burning your hands or arms. The sleeves protect against temperatures up to 1300 degrees F. Made of machine washable Nomex with a comfortable, breathable cotton/terry lining.

SKU	Description	UOM	Price
ESP100	Hot Not sleeve	EA	\$24.12



**C. Nylon Hairnets**

These disposable, 21" white hairnets are made of nylon.

SKU	Description	UOM	Price
MSCHN21W/10	Nylon Hairnets	100/BG	\$7.07



**D. Disposable Bouffant Cap**

Polypropylene bouffant cap is convenient and disposable.

SKU	Description	Color	Size	UOM	Price
MSCBC24W-10	Disposable bouffant cap	White	24"	1000/CS	\$31.10



**A**

### A. DuPont™ Tyvek® Boot Cover

Tyvek® garments are composed of flash spun high density polyethylene which creates a unique, nonwoven material available only from DuPont. Tyvek® provides an ideal balance of protection, durability and comfort of any limited use fabric technology. Tyvek® fabric offers an inherent barrier to small size particles. 18" high boot cover with elastic top provides coverage up to calf, one size fits most.

SKU	Description	Size	Color	UOM	Price
MSC903L/XL	Tyvek boot cover	L/XL	White	50 PR/CS	\$63.99



### B. Polypropylene Shoe Covers

Disposable shoe covers are polypropylene fabric construction w/latex non-skid coated soles.

SKU	Description	Color	Size	UOM	Price
MSCSC40LG	Non-skid polypropylene shoe covers	White/Blue	L	300/CS	\$28.67



**B**



**C**

### C. Arborchaps- Chainsaw Chaps

Users have long asked for a lower cost chap, and the trade has frequently requested a universal size chap to help control their inventory. The ArborChap might just be the answer to these requests, since it addresses both of these concerns. Elvex famous Prolar protective pads, no compromise on safety. Universal size, three sets of belt loops allow length adjustment from 33 to 36 inches. Easy on, easy off apron style design, with two sets of leg straps and buckles. Hunter green 420 denier Nylon cover fabric, with attractive black Nylon edging. Used only for chainsaw protection. Available in one universal size only JE-8000, Elvex ArborChaps.

SKU	Description	UOM	Price
ELVEJE-8000	ArborChaps	PR	\$88.06

### D. 94 Series ProChaps™

Elvex 94 Series ProChaps, are designed for the professional chain saw user. In addition to meeting the requirements of the ASTM Standard, Elvex 94 Series chap maintains the quality and features, which have made the Elvex brand name famous. Features include lightweight Prolar protective pads add comfort and prevent heat buildup. Patented asymmetric design with 1,000 denier Cordura Nylon cover fabric, which is more abrasive resistant. Three sets of leg straps and buckles help the stiffer cover fabric conform comfortably to the legs and a zippered front pocket is standard.

SKU	Description	UOM	Price
ELVEJE-9433	ProChaps	PR	\$123.01



**D**





**A. Rattlers Brand Snake Proof Gaiters**

Snake proof gaiters designed for improved fit plus greater comfort and convenience. Velcro closures make it easier to get gaiters on and off. A sturdy snap and adjustable web strap ensure a comfortable and secure fit. Beyond absolute snake bite protection, the 1000 denier Cordura® nylon gaiter is also waterproof and durable enough to withstand years of hard use.

SKU	Description	Calf	Color	Size	UOM	Price
RAT9000BRR	Snake proof gaiters	Up to 18"	Solid Brown	Husky	PR	\$68.00
RAT9000BRH	Snake proof gaiters	Up to 21"	Solid Brown	Husky	PR	\$68.00

A



B

**B. Snake Guardz™**

Snake Guardz™ are the original ultra light weight snake gaiter, with metatarsal protection, featuring a unique design which allows air circulation between the leg of the wearer and the Snake Guardz™. They are manufactured in 1000 Denier Nylons, Cotton and the new Whisper Quiet Amerisuede™, all with DWR water repellent coatings. 100% USA MADE

SKU	Description	Size	UOM	Price
SNAK-R-1942	Snake Guardz™ whisper quiet olive green	L	PR	\$72.37
SNAK-R-1942X	Snake Guardz™ whisper quiet olive green	XL	PR	\$72.37



**C. Stormfront™ 3 Piece Rainsuit**

The Stormfront™ 3-Piece Rain Suit is constructed of yellow .35 mm. PVC/Polyester fabric and includes a detachable hood with drawstring. Other features of this suit include a ventilated cape back and underarms, two flapped pockets, storm fly front with zipper & snap buttons, bib-style pants with suspenders and snap fly.

SKU	Colors	Sizes										UOM
MSR353Y	Yellow	M	L	XL	2X	3X	4X	5X	6X	7X	EA	
<b>Price</b>		\$8.13	\$8.13	\$8.13	\$8.13	\$8.13	\$8.62	\$8.62	\$9.01	\$9.72		

C



**D. Classic PVC/Poly Rainwear**

This 3-piece suit consists of bibbed pants, jacket and detachable hood in a bright safety yellow color. The suit is comfortable and durable and constructed of .35mm PVC layered to a polyester fabric. It is versatile enough for indoor and outdoor applications.

SKU	Colors	Sizes										UOM
MSR2003	Yellow		M	L	XL	2X	3X	4X	5X	6X	EA	
<b>Price: Three-piece suit</b>			\$7.89	\$7.89	\$7.89	\$8.20	\$8.51	\$8.73	\$8.96	\$10.75		
MSR200C	Yellow	S	M	L	XL	2X	3X	4X	5X	6X	EA	
<b>Price: 49" coat &amp; hood</b>		\$7.37	\$6.65	\$6.65	\$6.65	\$6.99	\$7.37	\$7.73	\$8.65	\$9.01		

D



MSR200C



MSR2003

MSR200C





### A. Commodore Heavy Duty PVC 3 Piece Rainsuit

This series is unique in that it has a ribbed texture on the outside and a soft and comfortable feel on the inside. This PVC/non-woven polyester and nylon construction allows the material to stay soft and pliable in all temperatures. Wicks away perspiration in warmer temps and adds just a touch of comfort in cool temps. Excellent all around weather suit.

SKU	Colors	Sizes					UOM
MSR6003	Yellow	M	L	XL	2X	3X	EA
<b>Price</b>		\$29.37	\$29.37	\$29.37	\$30.59	\$31.73	

### B. Zodiac Disposable 3 Piece Rainsuit

The Zodiac is a lightweight complete rain suit that comes in a handy tote pouch. Put one in your pocket in case it rains while your at the game - or in your glove compartment for those sudden emergencies. This disposable suit is good for light splash protection as well. Features: single ply .10mm PVC material, provides light splash protection and packaged in a handy tote pouch.

SKU	Colors	Sizes						UOM
MSR0503	Yellow	S	M	L	XL	2X	3X	CS
<b>Price</b>		\$225.44	\$223.78	\$223.78	\$223.78	\$235.98	\$244.45	50/case



MSR3882

### C. Chemical Rainsuit

Complete 2 piece rain suit consists of jacket w/attached hood, double enclosed zipper front and inner sleeves w/elastic wrist closure, and bib pants. Constructed from high tensile polyester material double coated with two thick layers of PVC for a combined thickness of .42 mm. Flame-retardant. Roomy construction. Great for chemical plants, refineries and environmental cleanups. Offers best protection against many chemicals and acids.

SKU	Colors	Sizes							UOM
MSR3881	Green	M	L	XL	2X	3X	4X	5X	EA
<b>Price: One-piece coverall</b>		\$33.68	\$33.68	\$33.68	\$35.15	\$36.70	\$38.24	\$39.71	
MSR3882	Green	M	L	XL	2X	3X	4X	5X	EA
<b>Price: Two-piece Suit</b>		\$35.56	\$35.56	\$35.56	\$37.26	\$38.89	\$40.52	\$42.23	

### D. Classic Plus Black Raincoat

This 49" raincoat with detachable hood is constructed from .35mm PVC layered to a polyester fabric. It features a corduroy lined collar and vented back for comfort. Two reach through pockets provide convenience for the wearer and the coat also includes a badge tab. This versatile raincoat can be used for indoor or outdoor applications.

SKU	Colors	Sizes								UOM
MSR247C	Black	S	M	L	XL	2X	3X	4X	5X	EA
<b>Price</b>		\$8.89	\$9.27	\$9.27	\$9.27	\$9.89	\$10.51	\$11.13	\$11.75	



MSR260C

MSR267C

### E. Classic Plus Rider Coats

This 2-piece rain coat features a detachable hood, 2 flap pockets, ventilated cape back and underarms, and a corduroy collar for comfort and versatility. Constructed of .35mm PVC and polyester this coat is 60" long and offers full body protection.

SKU	Colors	Sizes								UOM
MSR267C	Black	S	M	L	XL	2X	3X	4X	5X	EA
<b>Price</b>		\$16.43	\$16.43	\$16.43	\$16.43	\$17.00	\$17.73	\$18.39	\$19.20	
MSR260C	Yellow	S	M	L	XL	2X	3X	4X	5X	EA
<b>Price</b>		\$15.85	\$15.85	\$15.85	\$15.85	\$16.51	\$17.08	\$17.73	\$18.39	

### A. Seahorse™ Type IV Ring Buoy

The shell of this ring buoy is made of durable high density polyethylene that is U.V. stabilized. With 100% foam filling, the buoy will not absorb water if torn or punctured. The floating polypropylene grab line can be easily replaced in the field. For ferry-boats, cruise ships, wharf and dock work, offshore oil platforms, excursion boats, work boats and all other commercial applications. USCG Approval 160.050/131/0.

SKU	Description	Color	Size	UOM	Price
TAYRB3090BG	Type IV ring buoy with rope and bag	Orange	30" w/90" Rope	EA	\$107.12



A



B



### B. Seahorse™ Type V Fall Vest

Type V fall vest w/slot in the back facilitates wearing a fall restraint harness. Arrangement allows the snap hook and lanyard to be worn comfortably outside of the life jacket. Durable components are used to insure a long life of service. Flexible Ensolite® foam flotation pads cover a minimum body area to increase ventilation and promote freedom of movement. Closed-cell flotation foam will not absorb water if cut or punctured. Tough, flexible vinyl coating resists caustics, acids, UV light, hydrocarbons, mildew, fading, drilling mud, tears and abrasions and is easy to clean with soap and water. Webbing system is designed to take strains and loads. Innovative chest strap helps to hold the vest on the wearer during falls into the water and prevents the vest from riding up too high. Plastic buckles designed to not accidentally come undone or become a snag hazard. Buoyancy of the vest is greater than the USCG minimum. The bright international orange coating passes UL flame test UL1123. The life jacket can be adjusted to fit most adults (up to 56" chest). USCG Approval 160/053/88/0.

SKU	Description	Buoyancy Min	Size	UOM	Price
TAYSFV-10	Fall vest floatation device with slotted back	17.5 lbs	Up to 58" chest	EA	\$50.44
TAYSFV-10XL	Fall vest floatation device with slotted back	17.5 lbs	XL	EA	\$52.19
TAYSFV-10XXL	Fall vest floatation device with slotted back	17.5 lbs	2XL	EA	\$53.95
TAYSFV-103XL	Fall vest floatation device with slotted back	17.5 lbs	3XL	EA	\$55.70
TAYSFV-105XL	Fall vest floatation device with slotted back	17.5 lbs	5XL	EA	\$59.21



### C. General Purpose Adult Vest

This vest is made of durable Crosstech® flotation foam and features a 200 Denier nylon oxford shell. The three adjustable belts assure a correct fit for any adult. The side panels have SOLAS-grade 6755 3M™ Scotchlite™ Reflective Material ensuring visibility. USCG Approved Type III.

SKU	Description	Color	Size	UOM	Price
STE2001ORG	General Purpose Adult Vest	Orange	Universal	EA	\$39.12

C



D



Back

Front

### D. The Force II™ Vest

Rugged work vest for all-around industrial use. Aquafoam™ flotation foam retains buoyancy even when punctured. Coated with strong, durable, easy to clean PVC that is self-extinguishing under ASTM1692-74. Opening on back to accommodate most brands of fall protection harnesses, heavy-duty construction, and two body-encircling belts with snag resistant buckles. SOLAS-grade reflective panels. USCG Approved Type V.

SKU	Description	Color	Size	UOM	Price
STEI223ORG	The Force II Adult Vest	Orange	Universal	EA	\$46.95
STEI223ORGXX	The Force II Adult Vest	Orange	Oversized	EA	\$52.19



# FR Clothing





## **Custom Patches**

- Company Logo
- Specialty Logo

## **Flag Patches**

- USA Flag
- State Flag

## **Name Patch**

- Font Optional
- Color Optional

## **Embroidery**

- Nomex® Thread Embroidery
- Employee Name
- Division Name

See page 7 for more details.



***Garment Customization Services***





2112 Flash Fire & Arc Flash Protection

Built to withstand the toughest environments, the 2112 line of Flash Fire & Arc Flash Protective Clothing from Medsafe offers comprehensive protection in some of the world's most dangerous work environments. At Medsafe, Safety Begins With Us.

## Construction

- UL certified as a garment that meets or exceeds NFPA 2112
- CAT2, ATPV 9.6 cal/cm<sup>2</sup>

## Features & Benefits

- 2-way collar
- 2 Hidden Snaps at Front Placket (1-5/8" wide)
- 2 Patch Chest Pockets with flaps and pen opening on right wearing pocket
- One Piece Sleeve Construction, 2-1/2" Cuff, Snap at Cuff
- 2 Back Patch pockets with Hidden FR Snaps
- Banded Waist
- Hidden Snap at Waist
- Available Colors: Grey, Khaki and Navy Blue
- Packaging - Individual Poly Bag, UPC Size Sticker



### Medsafe 2112 Coveralls Measurement Tables

Size	36-S	38-S	40-M	42-M	44-L	46-L	48-XL	50-XL	52-XXL	54-XXL	56-3XL	58-3XL	60-4XL	62-4XL	64-5XL	66-5XL	68-6XL	70-6XL	72-7XL
Waist-Stretch	39	41	43	45	47	49	51	53	55	57	59	61	63	65	67	69	71	73	75
Chest	45-5/8	47-5/8	49-5/8	51-5/8	53-5/8	55-5/8	57-5/8	59-5/8	61-5/8	63-5/8	65-5/8	67-5/8	69-5/8	71-5/8	73-5/8	75-5/8	77-5/8	79-5/8	81-5/8
Seat	42-1/2	44-1/2	46-1/2	48-1/2	50	52	54	55-3/4	57-1/2	59-1/2	61-1/4	63	65	66-3/4	68-1/2	70-1/2	72-1/4	74	75-3/4
Thigh	25-3/4	26-7/8	27-7/8	29	30-1/8	31-1/8	32-1/8	33-1/4	34-1/4	35-3/8	36-3/8	37-3/8	38-1/2	39-5/8	40-5/8	41-3/4	42-3/4	43-3/4	44-3/4
Inseam	29-1/2	29-1/2	29-1/2	29-1/2	29-1/2	29-1/2	29-1/2	29-1/2	29-1/2	29-1/2	29-1/2	29-1/2	29-1/2	29-1/2	29-1/2	29-1/2	29-1/2	29-1/2	29-1/2
Shoulder Width	18	18-3/4	19-1/2	20-1/4	21	21-3/4	22-1/2	23-1/4	24	24-3/4	25-1/2	26-1/4	27	27-3/4	28-1/2	29-1/4	30	30-3/4	31-1/2
Sleeve Length	32-3/4	33-1/4	33-3/4	34-1/4	34-3/4	35-1/4	35-3/4	36-1/4	36-3/4	37-1/4	37-3/4	38-1/4	38-3/4	39-1/4	39-3/4	40-1/4	40-3/4	41-1/4	41-3/4
Trunk	70-3/4	71-1/2	72-1/4	73	73-3/4	74-1/2	75-1/4	76	76-3/4	77-1/2	78-1/4	79	79-3/4	80-1/2	81-1/4	82	82-3/4	83-1/2	84-1/4
Knee	21	21-1/2	22-1/4	23	23-1/2	24-1/4	24-3/4	25-1/2	26-1/4	27	27-3/4	28-1/4	28-3/4	29-1/2	30-1/4	31	31-3/4	32-1/2	33-1/4
Hem Bottom	19-1/4	19-1/2	19-3/4	20	20-1/4	20-1/2	20-3/4	21	21-1/4	21-1/2	21-3/4	22	22-1/4	22-1/2	22-3/4	23	23-1/4	23-1/2	23-3/4
Cuff	9-1/2	9-3/4	10	10-1/4	10-1/2	10-3/4	11	11-1/4	11-1/2	11-3/4	12	12-1/4	12-1/2	12-3/4	13	13-1/4	13-1/2	14-3/4	15
Zipper Length - RG	22-1/2	22-1/2	23	23	23-1/2	23-1/2	24	24	24-1/2	24-1/2	25	25	25-1/2	25-1/2	26	26	26-1/2	26-1/2	27
Zipper Length - LN	24	24	24-1/2	24-1/2	25	25	25-1/2	25-1/2	26	26	26-1/2	26-1/2	27	27	27-1/2	27-1/2	28	28	28-1/2





### A. 2112® FR 6 oz TrueComfort® 88/12 Coverall

These lightweight 6 oz. coveralls are made of FR TrueComfort® 88/12 fabric. They feature a 2-way collar, 2 hidden snaps at front placket, 2 patch chest pockets with flaps one piece sleeve construction, 2-1/2" cuff, snap at cuff. 2 back patch pockets, banded waist and hidden snap at waist. **All of our garments are UL certified and constructed with flame resistant fabric that is made in the USA. Our line of clothing is both 2112 and 70E certified.**

SKU	Colors	Sizes*								UOM
FRC6NV	Navy	S	M	L	XL	2X	3X	4X	5X	EA
<b>Price</b>		\$60.81	\$62.99	\$64.77	\$67.09	\$69.41	\$74.14	\$78.26	\$82.53	
FRC6GY	Grey	S	M	L	XL	2X	3X	4X	5X	EA
<b>Price</b>		\$60.81	\$62.99	\$64.77	\$67.09	\$69.41	\$74.14	\$78.26	\$82.53	
FRC6KH	Khaki	S	M	L	XL	2X	3X	4X	5X	EA
<b>Price</b>		\$60.81	\$62.99	\$64.77	\$67.09	\$69.41	\$74.14	\$78.26	\$82.53	
FRC6RB	Royal	S	M	L	XL	2X	3X	4X	5X	EA
<b>Price</b>		\$60.81	\$62.99	\$64.77	\$67.09	\$69.41	\$74.14	\$78.26	\$82.53	

\*Contact customer service for pricing and availability on tall sizes.

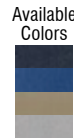

CAT 2 NFPA 2112



### B. 2112® FR 7 oz UltraSoft® 88/12 Coverall

These midweight 7 oz. coveralls are made of UltraSoft® 88/12 fabric. They feature a 2-way collar, 2 hidden snaps at front placket, 2 patch chest pockets with flaps one piece sleeve construction, 2-1/2" cuff, snap at cuff. 2 back patch pockets, banded waist and hidden snap at waist. **All of our garments are UL certified and constructed with flame resistant fabric that is made in the USA. Our line of clothing is both 2112 and 70E certified.**

SKU	Colors	Sizes*										UOM
FRC7NV	Navy	S	M	L	XL	2X	3X	4X	5X	6X	7X	EA
<b>Price</b>		\$57.64	\$59.62	\$61.23	\$63.34	\$65.45	\$69.98	\$73.83	\$77.83	\$79.35	\$80.62	
FRC7GY	Grey	S	M	L	XL	2X	3X	4X	5X	6X	7X	EA
<b>Price</b>		\$57.64	\$59.62	\$61.23	\$63.34	\$65.45	\$69.98	\$73.83	\$77.83	\$79.35	\$80.62	
FRC7KH	Khaki	S	M	L	XL	2X	3X	4X	5X	6X	7X	EA
<b>Price</b>		\$57.64	\$59.62	\$61.23	\$63.34	\$65.45	\$69.98	\$73.83	\$77.83	\$79.35	\$80.62	
FRC7RB	Royal	S	M	L	XL	2X	3X	4X	5X	6X	7X	EA
<b>Price</b>		\$57.64	\$59.62	\$61.23	\$63.34	\$65.45	\$69.98	\$73.83	\$77.83	\$79.35	\$80.62	

\*Contact customer service for pricing and availability on tall sizes.

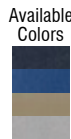

CAT 2 NFPA 2112



### C. 2112® FR 7 oz UltraSoft® Zip Pocket 88/12 Coverall

These midweight 7 oz. coveralls are made of UltraSoft® 88/12 fabric. They feature a 2-way collar, 2 hidden snaps at front placket, 2 zip chest pockets with flaps one piece sleeve construction, 2-1/2" cuff, snap at cuff. 2 back patch pockets, banded waist and hidden snap at waist. **All of our garments are UL certified and constructed with flame resistant fabric that is made in the USA. Our line of clothing is both 2112 and 70E certified.**

SKU	Colors	Sizes*					UOM
FRC7ZPNV	Navy	S	M	L	XL	2X	EA
<b>Price</b>		\$64.64	\$66.62	\$68.23	\$70.34	\$72.45	
FRC7ZPGY	Grey	S	M	L	XL	2X	EA
<b>Price</b>		\$64.64	\$66.62	\$68.23	\$70.34	\$72.45	
FRC7ZPKH	Khaki	S	M	L	XL	2X	EA
<b>Price</b>		\$64.64	\$66.62	\$68.23	\$70.34	\$72.45	
FRC7ZPRB	Royal	S	M	L	XL	2X	EA
<b>Price</b>		\$64.64	\$66.62	\$68.23	\$70.34	\$72.45	

\*Contact customer service for pricing and availability on tall sizes.

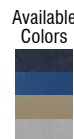

CAT 2 NFPA 2112



### D. 2112® FR 9 oz Indura® 100% Cotton Coverall

These heavyweight 9 oz. coveralls are made of Indura® 100% cotton fabric. They feature a 2-way collar, 2 hidden snaps at front placket, 2 patch chest pockets with flaps one piece sleeve construction, 2-1/2" cuff, snap at cuff. 2 back patch pockets, banded waist and hidden snap at waist. **All of our garments are UL certified and constructed with flame resistant fabric that is made in the USA. Our line of clothing is both 2112 and 70E certified.**

SKU	Colors	Sizes*								UOM	
FRC9NV	Navy	S	M	L	XL	2X	3X	4X	5X	6X	EA
<b>Price</b>		\$56.07	\$56.60	\$58.43	\$60.47	\$62.30	\$64.75	\$68.53	\$71.95	\$74.95	
FRC9GY	Grey	S	M	L	XL	2X	3X	4X	5X	6X	EA
<b>Price</b>		\$56.07	\$56.60	\$58.43	\$60.47	\$62.30	\$64.75	\$68.53	\$71.95	\$74.95	
FRC9KH	Khaki	S	M	L	XL	2X	3X	4X	5X	6X	EA
<b>Price</b>		\$56.07	\$56.60	\$58.43	\$60.47	\$62.30	\$64.75	\$68.53	\$71.95	\$74.95	
FRC9RB	Royal	S	M	L	XL	2X	3X	4X	5X	6X	EA
<b>Price</b>		\$56.07	\$56.60	\$58.43	\$60.47	\$62.30	\$64.75	\$68.53	\$71.95	\$74.95	

\*Contact customer service for pricing and availability on tall sizes.

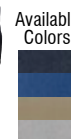

CAT 2 NFPA 2112





**A**

**CAT 2** NFPA 2112



### A. TEGGEN® Select 6.25 oz Coverall

TEGGEN® Select protects you from radiant heat, electric arc fires and flash fires, just like bulkier clothing. Only it isn't bulky. In fact, it's downright comfortable - and stays that way - even as the heat rises, because the patented fiber actually sucks moisture from your skin, where it quickly evaporates keeping you cool. Hey, firefighters wear this kind of stuff. Why shouldn't you? Lightweight 6.25 oz, inherently FR - will never wash or wear away. High air permeability means greater comfort with inherent moisture transport. Available in tan and navy blue. Specify size S - 7X.

**Meets NFPA 2112 requirements. NFPA 70E, CAT 2**

SKU	Colors	Sizes										UOM
TGN021208	Tan	S	M	L	XL	2X	3X	4X	5X	6X	7X	EA
<b>Price</b>		\$131.00	\$131.00	\$131.00	\$131.00	\$157.20	\$157.20	\$157.20	\$157.20	\$176.85	\$176.85	
TGN021608	Navy	S	M	L	XL	2X	3X	4X	5X	6X	7X	EA
<b>Price</b>		\$131.00	\$131.00	\$131.00	\$131.00	\$157.20	\$157.20	\$157.20	\$157.20	\$176.85	\$176.85	

### B. DuPont™ Nomex® IIIA 4.5 oz Coverall

Nomex IIIA Aramid is inherently flame resistant for the life of the garment. The flame resistant properties will not wash or wear out. The 4.5 oz. Contractor's Style Coverall is constructed with a two-way brass zipper front closure, by-swing back, two front, rear and breast pockets and concealed snap closures. This coverall also features an elastic waistband and a five-thread safety stitch. Made in USA. Available in royal blue, spruce green, gray, tan, black, orange and navy blue. Specify size S - 5XL. **UL® certified as a garment that meets NFPA 2112 requirements. NFPA 70E, CAT 1**



**B**

**CAT 1** NFPA 2112

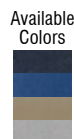

SKU	Colors	Sizes*										UOM
NOM45TAN	Tan	S	M	L	XL	2X	3X	4X	5X	EA		
<b>Price</b>		\$111.89	\$111.89	\$111.89	\$111.89	\$117.49	\$129.53	\$129.53	\$136.01			
NOM45GREY	Grey	S	M	L	XL	2X	3X	4X	5X	EA		
<b>Price</b>		\$111.89	\$111.89	\$111.89	\$111.89	\$117.49	\$123.36	\$129.53	\$136.01			
NOM45NVY	Navy Blue	S	M	L	XL	2X	3X	4X	5X	EA		
<b>Price</b>		\$111.89	\$111.89	\$111.89	\$160.82	\$117.49	\$123.36	\$129.53	\$136.01			
NOM45ROY	Royal Blue	S	M	L	XL	2X	3X	4X	5X	EA		
<b>Price</b>		\$111.89	\$110.53	\$111.89	\$111.89	\$117.49	\$123.36	\$129.53	\$136.01			

### C. Flame-Resistant 9 oz Cotton Insulated Coverall

Insulated coverall is made out of 9 oz flame-resistant, 100% cotton fabric. Sewn throughout with Nomex® thread. All stress points are bar-tacked for reinforcement. Lay-down collar, six pockets, pencil slot on left chest pocket and red FR tag on chest pocket. Snaps on pass-through pockets, double-layer rear pockets, and two-ply rear pocket bottom. Heavy duty (two-way) Nomex, brass zipper, and zipper flap with snap. Sewn bi-swing back, elastic waist-in back, reinforced waistband in front, and finished dress cuff with adjustable snap closure. Insulated for added warmth. Permanent label lists washing instructions, size, fiber content and RN#. Made in USA. Available in navy blue, royal blue and tan. **Meets NFPA 2112 requirements. NFPA 70E, CAT 2**



**C**

**CAT 2** NFPA 2112

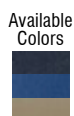

SKU	Colors	Sizes*										UOM
INDIJS16	Tan	S	M	L	XL	2X	3X	4X	5X	EA		
<b>Price</b>		\$201.75	\$201.75	\$201.75	\$201.75	\$211.84	\$222.42	\$233.53	\$245.19			
INDIJSNB	Navy	S	M	L	XL	2X	3X	4X	5X	EA		
<b>Price</b>		\$201.75	\$201.75	\$201.75	\$201.75	\$211.84	\$222.42	\$233.53	\$245.19			
INDIJSRB	Royal	S	M	L	XL	2X	3X	4X	5X	EA		
<b>Price</b>		\$201.75	\$201.75	\$201.75	\$201.75	\$211.84	\$222.42	\$233.53	\$245.19			

\*Contact customer service for pricing and availability on short and tall sizes.

**A. 2112® FR 6 oz TrueComfort® 88/12 Shirt**



Built to withstand the toughest environments, the 2112 line of Flash Fire & Arc Flash Protective Clothing from Medsafe offers comprehensive protection in some of the world's most dangerous work environments. These lightweight 6 oz. shirts are made of FR TrueComfort® 88/12 fabric. **All of our garments are UL certified and constructed with flame resistant fabric that is made in the USA. Our line of clothing is both 2112 and 70E certified.**

SKU	Colors	Sizes								UOM
\$45.80	Navy	M	L	XL	2X	3X	4X	5X	6X	EA
<b>Price</b>		\$41.42	\$42.21	\$44.47	\$45.80	\$48.53	\$51.43	\$53.12	\$61.03	
FRS6KH	Khaki	M	L	XL	2X	3X	4X	5X	6X	EA
<b>Price</b>		\$41.42	\$42.21	\$44.47	\$45.80	\$48.53	\$51.43	\$53.12	\$56.55	
FRS6GY	Grey	M	L	XL	2X	3X	4X	5X	6X	EA
<b>Price</b>		\$41.42	\$42.21	\$44.47	\$45.80	\$48.53	\$51.43	\$53.12	\$56.55	
FRS6RB	Royal	M	L	XL	2X	3X	4X	5X	6X	EA
<b>Price</b>		\$41.42	\$42.21	\$44.47	\$45.80	\$48.53	\$51.43	\$53.12	\$56.55	



CAT 2 NFPA 2112

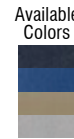

**B. 2112® FR 7 oz UltraSoft® 88/12 Shirt**

Built to withstand the toughest environments, the 2112 line of Flash Fire & Arc Flash Protective Clothing from Medsafe offers comprehensive protection in some of the world's most dangerous work environments. These midweight 7 oz. shirts are made of UltraSoft® 88/12 fabric. **All of our garments are UL certified and constructed with flame resistant fabric that is made in the USA. Our line of clothing is both 2112 and 70E certified.**

SKU	Colors	Sizes								UOM
FRS7NV	Navy	M	L	XL	2X	3X	4X	5X	6X	EA
<b>Price</b>		\$39.37	\$40.09	\$42.14	\$43.34	\$45.99	\$48.71	\$50.33	\$53.53	
FRS7KH	Khaki	M	L	XL	2X	3X	4X	5X	6X	EA
<b>Price</b>		\$39.37	\$40.09	\$42.14	\$43.34	\$45.99	\$48.71	\$50.33	\$53.53	
FRS7GY	Grey	M	L	XL	2X	3X	4X	5X	6X	EA
<b>Price</b>		\$39.37	\$40.09	\$42.14	\$43.34	\$45.99	\$48.71	\$50.33	\$53.53	
FRS7RB	Royal	M	L	XL	2X	3X	4X	5X	6X	EA
<b>Price</b>		\$39.37	\$40.09	\$42.14	\$43.34	\$45.99	\$48.71	\$50.33	\$53.53	



CAT 2 NFPA 2112

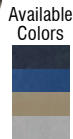

**Medsafe 2112 Shirts Measurement Tables**

Size	XS	S	M	L	XL	2X	3X	4X	5X	6X	Long
Neck Button Top BH	13-3/4	14-1/2	15-1/4	16	17-1/4	18-1/2	19-3/4	20-1/2	21-1/4	22	
Across Shoulder	16-1/2	18	19-1/2	21	22-1/2	24	25-1/2	27	28-1/2	30	
Sleeve Length CBN	33-3/4	34-1/4	34-3/4	35-1/4	35-3/4	36-1/4	36-3/4	37-1/4	37-3/4	38-1/4	.+1"
Cuff Closed	8	8-1/2	8-1/2	9-1/2	9-1/2	10-1/2	10-1/2	11-1/2	11-1/2	12	
Upperarm @ Armhole	18-3/4	19-3/4	20-3/4	21-3/4	22-3/4	23-3/4	24-3/4	25-3/4	26-3/4	27-3/4	
Chest @ Armhole	38	42	46	50	54	58	62	66	70	74	
Waist @ Narrowest Point	39	43	47	51	55	59	63	67	71	75	
Sweep	41-1/2	45-1/2	49-1/2	53-1/2	57-1/2	61-1/2	65-1/2	69-1/2	73-1/2	77-1/2	
Center Back Length	32-3/4	33-1/4	33-3/4	34-1/4	34-3/4	35-1/4	35-3/4	35-3/4	36-1/4	36-1/4	.+2"





CAT 2 NFPA 2112



A

Available Colors

### A. Wrangler® FR Long Sleeve Western Shirt

Flame Resistant Collection. Long sleeves. Spread collar. Authentic western front and back yokes. Two authentic western snap flap pockets with pencil slot at left pocket flap. W stitching on pocket. Wrangler® logo ribbon label on left pocket. Flame resistant ribbon label at inside cuff. Authentic western three snap cuffs. Authentic western quarter-turn tail. 100% cotton 7.5 oz. flame resistant yarn dyed indigo denim. **Meets NFPA 2112 requirements. NFPA 70E, CAT 2**

SKU	Colors	Sizes								UOM
VFFR70127	Denim	S	M	L	XL	2X	3X	4X	EA	
<b>Price</b>		\$70.18	\$70.18	\$70.18	\$70.18	\$70.18	\$70.18	\$72.81		
VFFR70140	Khaki	S	M	L	XL	2X	3X	4X	EA	
<b>Price</b>		\$70.18	\$70.18	\$70.18	\$70.18	\$70.18	\$70.18	\$72.81		

### B. Riggs Workwear® By Wrangler® FR Denim Work Shirt

Wrangler FR® garments are designed to self-extinguish preventing or greatly reducing the severity of burn injuries. Wrangler® FR products were created to meet the rigorous requirements of the major protection agencies. Long Sleeves. 100% Cotton FR 7.5 oz. Comfortable Relaxed Fit. Button-Thru Rounded Patch Pocket with Pencil Slot. Safety Orange Outside ID for High Visibility. **Meets NFPA 2112 requirements. NFPA 70E, CAT 2**

SKU	Colors	Sizes						UOM
VFFR3W5D2	Denim	M	L	XL	2X	3X	4X	EA
<b>Price</b>		\$63.16	\$63.16	\$63.16	\$63.16	\$63.16	\$63.16	

B



CAT 2 NFPA 2112

Available Colors

CAT 2 NFPA 2112



C

Available Colors

### C. Riggs Workwear® By Wrangler® FR Long Sleeve Henley

Wrangler FR® garments are designed to self-extinguish preventing or greatly reducing the severity of burn injuries. Wrangler® FR products were created to meet the rigorous requirements of the major protection agencies. 100% Cotton FR Jersey. Comfortable Relaxed Fit. Front Chest Pocket. Safety Orange Outside ID for High Visibility. **CAT 2, NFPA 70E and NFPA 2112 compliant.**

SKU	Colors	Sizes					UOM
VFFR3W8NV	Navy	M	L	XL	2X	3X	EA
<b>Price</b>		\$63.16	\$63.16	\$63.16	\$63.16	\$63.16	



Protection. Done right.

### D. TEGGEN Select® 5.5 oz Long Sleeve Shirts

TEGGEN SELECT® protects you from radiant heat, electric arc fires and flash fires, just like bulkier clothing. Only it isn't bulky. In fact, it's downright comfortable - and stays that way - even as the heat rises, because the patented fiber actually sucks moisture from your skin, where it quickly evaporates keeping you cool. Hey, firefighters wear this kind of stuff. Why shouldn't you? Lightweight 5.5 oz, inherently FR - will never wash or wear away. High air permeability means greater comfort with inherent moisture transport. **Meets NFPA 2112 requirements. NFPA 70E, CAT 2**

SKU	Colors	Sizes										UOM
TGN011202	Tan	S	M	L	XL	2X	3X	4X	5X	6X	7X	EA
<b>Price</b>		\$70.04	\$70.04	\$70.04	\$70.04	\$84.04	\$84.04	\$84.04	\$84.04	\$94.55	\$94.55	
TGN011602	Navy	S	M	L	XL	2X	3X	4X	5X	6X	7X	EA
<b>Price</b>		\$70.04	\$70.04	\$70.04	\$70.04	\$84.04	\$84.04	\$84.04	\$84.04	\$94.55	\$94.55	

D



CAT 2 NFPA 2112

Available Colors

### A. Carhartt® 6 oz FR Work-Dry 88/12 Lightweight Twill Shirt

Carhartt's flame-resistant Work-Dry® lightweight twill shirt is a comfortable choice on warmer days. Constructed of lightweight, 6-ounce FR twill in a blend of 88% cotton and 12% high-tenacity nylon, its Work-Dry® material wicks away moisture for comfort and features an anti-odor fabric treatment. Two chest pockets with flaps and button closures add utility, and two-button adjustable cuffs enhance fit. **Meets NFPA 2112 requirements. NFPA 70E, CAT 2**

SKU	Colors	Sizes							UOM
CTS003NV	Navy	S	M	L	XL	2X	3X	4X	EA
<b>Price</b>		\$62.65	\$62.65	\$62.65	\$62.65	\$62.65	\$69.16	\$69.16	
CTS003KH	Khaki	S	M	L	XL	2X	3X	4X	EA
<b>Price</b>		\$62.65	\$62.65	\$62.65	\$62.65	\$62.65	\$69.16	\$69.16	
CTS003MBL	Med Blue	S	M	L	XL	2X	3X	4X	EA
<b>Price</b>		\$62.65	\$62.65	\$62.65	\$62.65	\$62.65	\$69.16	\$69.16	
CTS003RB	Royal	S	M	L	XL	2X	3X	4X	EA
<b>Price</b>		\$62.65	\$62.65	\$62.65	\$62.65	\$62.65	\$69.16	\$69.16	
CTS003GRY	Grey	S	M	L	XL	2X	3X	4X	EA
<b>Price</b>		\$62.65	\$62.65	\$62.65	\$62.65	\$62.65	\$69.16	\$69.16	

\*Contact customer service for pricing and availability on tall sizes.

A

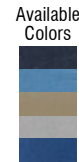

CAT 2 NFPA 2112

### B. Carhartt® 7 oz FR Twill Shirt

Carhartt's flame-resistant twill shirt with pocket flaps works as hard as you do. Made of 7-ounce, flame-resistant twill, it features two chest pockets with flaps and button closures, flame-resistant melamine buttons and a button-down collar. It also has triple-stitched main seams and a shaped shirt tail. NFPA 70E and NFPA 2112 compliant. **UL® certified as a garment that meets NFPA 2112 requirements. NFPA 70E, CAT 2**

SKU	Colors	Sizes							UOM
CTS160NV	Navy	S	M	L	XL	2X	3X	4X	EA
<b>Price</b>		\$62.65	\$62.65	\$62.65	\$62.65	\$62.65	\$69.16	\$69.16	
CTS160K	Khaki	S	M	L	XL	2X	3X	4X	EA
<b>Price</b>		\$62.65	\$62.65	\$62.65	\$62.65	\$62.65	\$69.16	\$69.16	
CTS160GY	Grey	S	M	L	XL	2X	3X	4X	EA
<b>Price</b>		\$62.65	\$62.65	\$62.65	\$62.65	\$62.65	\$69.16	\$69.16	

\*Contact customer service for pricing and availability on tall sizes.

B

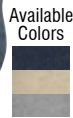

CAT 2 NFPA 2112



### C. Carhartt® 6.75 oz FR Force® Cotton Long-Sleeve T-Shirt

Carhartt's easiest-wearing, hardest-working 6.75-ounce, 100% cotton FR jersey knit T-Shirt wicks away sweat for comfort and fights odors. It features a rib-knit crewneck collar and cuffs, a convenient left-chest pocket, and side-seamed construction that minimizes twisting. Carhartt FR and CAT 2 labels are sewn on the pocket. **UL® certified as a garment that meets NFPA 2112 requirements. NFPA 70E, CAT 2**

SKU	Colors	Sizes							UOM
CT100235DN	Navy	S	M	L	XL	2X	3X	4X	EA
<b>Price</b>		\$59.40	\$59.40	\$59.40	\$59.40	\$59.40	\$68.35	\$68.35	
CT100235LG	Light Grey	S	M	L	XL	2X	3X	4X	EA
<b>Price</b>		\$59.40	\$59.40	\$59.40	\$59.40	\$59.40	\$68.35	\$68.35	
CT100235SS	Sandstone	S	M	L	XL	2X	3X	4X	EA
<b>Price</b>		\$59.40	\$59.40	\$59.40	\$59.40	\$59.40	\$68.35	\$68.35	
CT100235MB	Med Blue	S	M	L	XL	2X	3X	4X	EA
<b>Price</b>		\$59.40	\$59.40	\$59.40	\$59.40	\$59.40	\$68.35	\$68.35	

\*Contact customer service for pricing and availability on tall sizes.

C

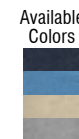

CAT 2 NFPA 2112



### D. Carhartt® 6.75 oz FR Cotton Long-Sleeve Henley

Carhartt's easiest-wearing, hardest-working 6.75-ounce, 100% cotton FR jersey knit Henley wicks away sweat for comfort and fights odors. It features a rib-knit Henley collar and rib-knit cuffs, a 3-button front, a convenient left-chest pocket, and side-seamed construction that minimizes twisting. Carhartt FR and CAT 2 labels are sewn on the pocket. **UL® certified as a garment that meets NFPA 2112 requirements. NFPA 70E, CAT 2**

SKU	Colors	Sizes							UOM
CT0237DN	Navy	S	M	L	XL	2X	3X	4X	EA
<b>Price</b>		\$62.65	\$62.65	\$62.65	\$62.65	\$62.65	\$69.16	\$69.16	
CT0237LG	Light Grey	S	M	L	XL	2X	3X	4X	EA
<b>Price</b>		\$62.65	\$62.65	\$62.65	\$62.65	\$62.65	\$69.16	\$69.16	
CT0237SS	Sandstone	S	M	L	XL	2X	3X	4X	EA
<b>Price</b>		\$62.65	\$62.65	\$62.65	\$62.65	\$62.65	\$69.16	\$69.16	
CT0237MB	Med Blue	S	M	L	XL	2X	3X	4X	EA
<b>Price</b>		\$62.65	\$62.65	\$62.65	\$62.65	\$62.65	\$69.16	\$69.16	

\*Contact customer service for pricing and availability on tall sizes.

D

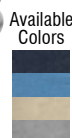

CAT 2 NFPA 2112





A

CAT 2 NFPA 2112

Available Colors



### A. Wrangler® Original Fit FR Jean

Wrangler® Original Fit Jean. Authentic five pocket styling. 100% cotton heavyweight broken twill denim. **Meets NFPA 2112 requirements. NFPA 70E, CAT 2**

SKU	Colors	Size: Waist	UOM
VFFR13	Denim	30-42	EA
<b>Price</b>		\$64.91	

B



CAT 2 NFPA 2112

Available Colors

### B. Wrangler® Relaxed Fit FR Jean

Wrangler® Relaxed Fit Jean. Authentic five pocket styling. Utility pocket. Gusset. 100% cotton heavyweight broken twill denim. **Meets NFPA 2112 requirements. NFPA 70E, CAT 2**

SKU	Colors	Size: Waist	UOM
VFFR31	Denim	30-42	EA
<b>Price</b>		\$64.91	



C

CAT 2 NFPA 2112

Available Colors

### C. Riggs Workwear® By Wrangler® FR Carpenter Jean Pant

Wrangler FR® garments are designed to self-extinguish preventing or greatly reducing the severity of burn injuries. Wrangler® FR products were created to meet the rigorous requirements of the major protection agencies. Carpenter pant with exclusive room2move™ Fit: Improved fit in the seat, thigh, knee and bottom leg opening. Action gusset for ease of movement. Features: 14.5 oz. 100% Cotton FR Denim; Triple Needle Stitching; Extra Deep 13" FR Treated Front Pockets; Reinforced Back Pockets; Oversized Watch Pocket; Right Side Hammer Loop; Tool Pocket Detail; Safety Orange Outside ID for High Visibility. **Meets NFPA 2112 requirements. NFPA 70E, CAT 2**

SKU	Colors	Size: Waist	UOM
VFFR33	Denim	30-40	EA
<b>Price</b>		\$62.28	



### D. TECGEN® Select 8.5 oz FR Work Pants

TECGEN SELECT® protects you from radiant heat, electric arc fires and flash fires, just like bulkier clothing. Only it isn't bulky. In fact, it's downright comfortable - and stays that way - even as the heat rises, because the patented fiber actually sucks moisture from your skin, where it quickly evaporates keeping you cool. Hey, firefighters wear this kind of stuff. Why shouldn't you? Lightweight 8.5 oz, inherently FR - will never wash or wear away. High air permeability means greater comfort with inherent moisture transport. **Meets NFPA 2112 requirements. NFPA 70E, CAT 2**

SKU	Colors	Size: Waist	UOM
TGN5016	Navy	30-42 44-50	EA
<b>Price</b>		\$72.28 \$86.74	

D



CAT 2 NFPA 2112

Available Colors





### A. Carhartt® 11.75 oz FR Cotton Denim Dungaree

For flame-resistant protection in a high-quality jean that's built to last, Carhartt's flame-resistant denim dungaree is a great workwear choice. It's NFPA 70E and NFPA 2112 compliant and made of 11.75-ounce, midweight, flame-resistant denim, 100% cotton, sits below the waist and has a full seat and thigh. The pant features an arc-resistant high-tension snap closure at the waist, a brass zipper fly with Nomex® zipper tape and 19" leg openings to fit over work boots. **Meets NFPA 2112 requirements. NFPA 70E, CAT 2**

SKU	Colors	Size: Waist		UOM
CTP13DM	Denim	30-50	52-54	EA
<b>Price</b>		\$71.61	\$78.12	

A

Available Colors



CAT 2 NFPA 2112

B

### B. Carhartt® 11.75 oz FR Cotton Relaxed Fit Jean

Carhartt's flame-resistant relaxed fit jean is garment washed for softness. Made of 11.75-ounce, 100% cotton flame-resistant denim, it sits slightly below the waist, is relaxed-fitting seat and thigh, arc-resistant button closure at waist, brass zipper fly with Nomex® zipper tape. It also has reinforced back pockets, double-stitched main seams and leg openings that fit over boots. **Meets NFPA 2112 requirements. NFPA 70E, CAT 2**

SKU	Colors	Size: Waist		UOM
CTP100	Denim	30-50	52-54	EA
<b>Price</b>		\$63.47	\$69.98	

CAT 2 NFPA 2112

Available Colors



C

### C. Carhartt® 14.5 oz FR Cotton Relaxed Fit Utility Jean

Carhartt's flame-resistant relaxed fit utility jean is made of 14.5-ounce, flame-resistant denim, 100% cotton. It sits slightly below the waist and has a relaxed seat and thigh. The pant features an arc-resistant button closure at waist, straight leg opening and a brass zipper fly with Nomex® zipper tape. **Meets NFPA 2112 requirements. NFPA 70E, CAT 2**

SKU	Colors	Size: Waist		UOM
CTP004MS	Denim	30-50	52-54	EA
<b>Price</b>		\$68.35	\$74.86	

Available Colors



CAT 2 NFPA 2112

D

### D. Carhartt® 8.5 oz FR 88/12 Canvas Cargo Pant

Discover the Carhartt Difference in Carhartt's flame-resistant canvas cargo pant. Made of 8.5-ounce FR, a blend of 88% cotton/12% high-tenacity cotton, it sits slightly below the natural waist, has a full seat and thigh, triple-stitched main seams, arc-resistant button closure at waist, brass zipper fly with Nomex® FR zipper tape, two large side cargo pockets with pen slots and two reinforced back pockets. Leg openings fit over work boots. **Meets NFPA 2112 requirements. NFPA 70E, CAT 2.**

SKU	Colors	Size: Waist		UOM
CTP240K	Khaki	30-50	52-54	EA
<b>Price</b>		\$86.25	\$92.76	
CTP240N	Dark Navy	30-50	52-54	EA
<b>Price</b>		\$86.25	\$92.76	

CAT 2 NFPA 2112

Available Colors





**A**

**CAT 2** NFPA 2112

Available Colors



### A. Carhartt® 8.5 oz FR 88/12 Loose Fit Midweight Canvas Jean

Carhartt's flame-resistant loose fit midweight canvas jean is great for warmer weather. Made of 8.5-ounce flame-resistant canvas, an 88% cotton / 12% high-tenacity nylon blend, it has a loose seat and thigh and sits slightly below the natural waist for a comfortable fit. The brass zipper fly has Nomex® zipper tape and the high-tension waist snap closure is arc resistant. It also has a cell phone pocket, utility pocket, triple-stitched main seams, and a 19-inch leg opening that fits over work boots. **Meets NFPA 2112 requirements. NFPA 70E, CAT 2**

SKU	Colors	Size: Waist		UOM
CTP159KH	Khaki	30-50	52-54	EA
<b>Price</b>		\$78.12	\$86.25	
CTP159DN	Dark Navy	30-50	52-54	EA
<b>Price</b>		\$78.12	\$86.25	
CTP159DB	Dark Brown	30-50	52-54	EA
<b>Price</b>		\$78.12	\$86.25	
CTP159MS	Moss	30-50	52-54	EA
<b>Price</b>		\$78.12	\$86.25	

### B. Carhartt® 13 oz FR Cotton Duck Unlined Bib Overall

Carhartt's flame-resistant duck bib overall is unlined for comfort in warmer weather. Made of 13-ounce, flame-resistant 100% cotton duck, it features high back with flame-resistant elastic suspenders and high temperature nylon center-release buckles. It also has a chap-style double front for durability, multiple tool and utility pockets, ankle-to-mid-thigh brass leg zippers with Nomex® zipper tape, flame-resistant melamine button at waist and protective flaps and arc-resistant snap closures. **NFPA 70E compliant, CAT 2.**

SKU	Colors	Size: Waist		UOM
CTFRR45B	Brown	30-50	52-54	EA
<b>Price</b>		\$131.82	\$144.84	
CTFRR45D	Navy	30-48	50-54	EA
<b>Price</b>		\$131.82	\$144.84	

**B**



**CAT 2** NFPA 70E

Available Colors



**C**

**CAT 4** NFPA 70E

Available Colors



### C. Carhartt® 13 oz FR Cotton Duck Quilt Lined Bib Overall

Add warmth to your workwear with our flame-resistant duck bib overalls. Made of 13-ounce, flame-resistant 100% cotton duck, it features a quilt lining, a high back with flame-resistant elastic suspenders and high temperature nylon center-release buckles. They also have a chap-style double front for durability, flame-resistant melamine button at waist, multiple tool and utility pockets, ankle-to-mid-thigh brass leg zippers with Nomex® zipper tape and protective flaps and arc-resistant snap closures. **NFPA 70E compliant, CAT 4.**

SKU	Colors	Size: Waist		UOM
CTFRR44D	Navy	30-50	52-54	EA
<b>Price</b>		\$242.49	\$265.28	
CTFRR44B	Brown	30-48	50-54	EA
<b>Price</b>		\$242.49	\$265.28	



CAT 4 NFPA 2112



### A. 2112® FR 9 oz Indura® Bomber Jacket

The 2112 Bomber Jacket features an outer shell made of 9 oz. Indura® fabric, 100% cotton liner, heavy duty brass zipper fully covered with storm flap and concealed Velcro closure, stand-up collar with optional Velcro hood attachment, Velcro sleeve closures, 2 combination cargo/slash pockets, 1 Internal cell phone pocket and a D-Ring pass-through. Available in sizes small up to 5X-large. **All of our garments are UL certified and constructed with flame resistant fabric that is made in the USA. Our line of clothing is both 2112 and 70E certified.**

SKU	Colors	Sizes								UOM
FRJKTNVY	Navy Blue	S	M	L	XL	2X	3X	4X	5X	EA
<b>Price</b>		\$165.00	\$165.00	\$165.00	\$165.00	\$165.00	\$181.00	\$189.15	\$191.15	

Available Colors  
■



CAT 4 NFPA 2112



B

Available Colors  
■

### B. 2112® FR 9 oz Indura® Parka

The 2112 Parka features an outer shell made of 9 oz. Indura® fabric, 100% cotton liner, heavy duty brass zipper fully covered with storm flap and concealed Velcro closure, stand-up collar with optional Velcro hood attachment, Velcro sleeve closures, 2 combination cargo/slash pockets, 1 Internal cell phone pocket and a D-Ring pass-through. Available in sizes small up to 5X-large. **All of our garments are UL certified and constructed with flame resistant fabric that is made in the USA. Our line of clothing is both 2112 and 70E certified.**

SKU	Colors	Sizes								UOM
FRPKANVY	Navy Blue	S	M	L	XL	2X	3X	4X	5X	EA
<b>Price</b>		\$191.15	\$191.15	\$191.15	\$191.15	\$191.15	\$210.25	\$220.00	\$230.00	



### C. Parka - Nomex® IIIA

The Parka - Nomex® IIIA features two-way, separating, extra heavy-duty nomex®, taped brass zipper, fully covered with insulated storm flap, hook-and-loop secured, fully insulated stand-up collar, knit storm cuff within hemmed sleeve end with hook-and-loop suppression tabs, three large external patch pockets with hook-and-loop secured flaps (lower pockets with hand warmers), one inside chest pocket, sleeve pocket, deep-pleated action back, elastic inserts at waist across back, inside zipper guards on all zippers, internal snow belt and accommodates snap-on hood BWKHNH2NV, sold separately.

Fabric - Outershell: Flame-resistant, 6 oz. Water Repellant Nomex® IIIA (93% Nomex® Aramid / 5% Kevlar® Aramid / 2% Other Fiber). Insulation: Flame-resistant 14.2 oz. Quilted Nomex® with Wind and Moisture Barrier.

Care - Home Wash and Light Soil Wash

Protection - CAT 4, NFPA 70E and NFPA 2112 compliant.

SKU	Colors	Sizes						UOM
BWKJNP2NV	Navy Blue	S	M	L	XL	2X	3X	EA
<b>Price</b>		\$352.45	\$352.45	\$352.45	\$352.45	\$422.93	\$422.93	
BWKHNH2NV	Navy Blue	One Size						EA
<b>Price: Hood</b>		\$57.41						



CAT 4 NFPA 2112

Available Colors  
■



**CAT 4** NFPA 70E



**A**

Available Colors



### A. Carhartt® FR 13 oz Cotton Duck Bomber Jacket/Quilt-Lined

Carhartt's flame-resistant duck bomber quilt-lined jacket will keep you warm in cooler weather. Made of 13-ounce, 100% cotton flame-resistant duck with a 10.5-ounce flame-resistant quilt lining, it has two inside patch pockets with flame resistant hook-and-loop closure for convenient storage and Nomex® rib-knit cuffs and waistband. It also features a brass front zipper with Nomex® zipper tape that has inside and outside protective flaps and hidden snap closure for electric arc protection. An optional flame-resistant hood can be attached with snaps under the collar. **CAT 4, NFPA 70E compliant.**

SKU	Colors	Sizes								UOM
CTJ195BR	Brown	S	M	L	XL	2X	3X	4X	5X	EA
<b>Price</b>		\$190.41	\$190.41	\$190.41	\$190.41	\$190.41	\$216.45	\$216.45	\$216.45	
CTJ195DNY	Navy	S	M	L	XL	2X	3X	4X	5X	EA
<b>Price</b>		\$190.41	\$190.41	\$190.41	\$190.41	\$190.41	\$216.45	\$216.45	\$216.45	

*\*Contact customer service for pricing and availability on tall sizes.*

### B. Carhartt® FR 13 oz Cotton Duck Traditional Coat/Quilt-Lined

Protect yourself from flash fire or electric arcs on the job. Carhartt's flame-resistant duck traditional coat is quilt-lined and made of 13-ounce flame-resistant, 100% cotton duck. It features two inside patch pockets with flame-resistant hook-and-loop closures, Nomex® inside-waist drawcord for an adjustable fit, rib-knit storm cuffs to seal out cold air, a two-way brass zipper and snaps under the collar for an optional hood (FRA265). **It is NFPA 70E compliant, CAT 4.**

SKU	Colors	Sizes								UOM
CTC066BRN	Brown	S	M	L	XL	2X	3X	4X	EA	
<b>Price</b>		\$209.94	\$209.94	\$209.94	\$209.94	\$209.94	\$235.98	\$235.98		
CTC066DNY	Navy	S	M	L	XL	2X	3X	4X	EA	
<b>Price</b>		\$209.94	\$209.94	\$209.94	\$209.94	\$235.99	\$235.98	\$235.98		
CTC066BLK	Black	S	M	L	XL	2X	3X	4X	EA	
<b>Price</b>		\$209.94	\$209.94	\$209.94	\$209.94	\$209.94	\$235.98	\$235.98		
CTC066STL	Steel	S	M	L	XL	2X	3X	4X	EA	
<b>Price</b>		\$209.94	\$209.94	\$209.94	\$209.94	\$209.94	\$235.98	\$235.98		

*\*Contact customer service for pricing and availability on tall sizes.*



**B**

**CAT 4** NFPA 70E

Available Colors



**CAT 4** NFPA 70E



**C**

Available Colors



### C. Carhartt® FR 8.5 oz Cotton Active Jacket/Quilt-Lined

Made in the USA, Carhartt's flame-resistant duck active jac is a combination of durability, comfort and protection. Made of 13-ounce, flame-resistant 100% cotton duck, it is quilt-lined and features two inside patch pockets with flame-resistant hook-and-loop closures, Nomex® rib-knit cuffs and waistband and a brass front zipper with Nomex® zipper tape and hidden snap closure for electric arc protection. **CAT 4, NFPA 70E compliant.**

SKU	Colors	Sizes								UOM
CTJ184BRN	Brown	S	M	L	XL	2X	3X	4X	EA	
<b>Price</b>		\$206.69	\$206.69	\$206.69	\$206.69	\$206.69	\$234.36	\$234.36		
CTJ184DNY	Navy	S	M	L	XL	2X	3X	4X	EA	
<b>Price</b>		\$206.69	\$206.69	\$206.69	\$206.69	\$206.69	\$234.36	\$234.36		
CTJ184BLK	Black	S	M	L	XL	2X	3X	4X	EA	
<b>Price</b>		\$206.69	\$206.69	\$206.69	\$206.69	\$206.69	\$234.36	\$234.36		

*\*Contact customer service for pricing and availability on tall sizes.*

### D. Carhartt® 14 oz FR Heavyweight Zip-Front Hooded Sweatshirt

Carhartt's heavyweight zip-front sweatshirt is now available in flame-resistant fabric. Made of heavyweight flame-resistant 14-ounce knit, 58% cotton/35% modacrylic/7% polyester, it features an attached hood and FR draw cord closure and two front handwarmer pockets. A Carhartt FR and CAT 3 labels are sewn on the left-front pocket. **CAT 3, NFPA 70E compliant.**

SKU	Colors	Sizes								UOM
CTFRK007N	Navy	S	M	L	XL	2X	3X	4X	5X	EA
<b>Price</b>		\$149.73	\$149.73	\$149.73	\$149.73	\$149.73	\$166.00	\$154.61	\$154.61	

*\*Contact customer service for pricing and availability on tall sizes.*

**D**

**CAT 3** NFPA 70E

Available Colors



### A. Carhartt® 14 oz FR Heavyweight Hooded Sweatshirt

When cold weather is in the forecast, reach for Carhartt's flame-resistant heavyweight hooded sweatshirt for warmth. It's constructed of heavyweight, flame-resistant 14-ounce knit, 58% cotton/35% modacrylic/7% polyester. For added comfort, it features an attached hood with adjustable draw-cord closure, and a front hand-warmer pocket. Anti-odor control is also included. **Meets NFPA 70E standards.**

SKU	Colors	Sizes								UOM
CTK006N	Navy	S	M	L	XL	2X	3X	4X	5X	EA
<b>Price</b>		\$135.08	\$135.08	\$135.08	\$135.08	\$135.08	\$146.47	\$146.47	\$146.47	

*\*Contact customer service for pricing and availability on tall sizes.*



**CAT 3** NFPA 70E

Available Colors

**CAT 1** NFPA 2112



**B**

Available Colors

### B. DuPont™ Nomex® IIIA Jacket with Zip-In Liner

Nomex IIIA Aramid is inherently flame resistant for the life of the garment. The flame resistant properties will not wash or wear out. This banded waist-style "ike" jacket features two slant front pockets, zipper front closure and 6.0 oz. Nomex with zipper for zip-in double-faced modaquit liner. Permanent label lists washing instructions and size. Made in USA. Available in royal blue, spruce green, gray, tan, orange and navy blue. Specify size S - 5XL. **Meets NFPA 2112 requirements. NFPA 70E, CAT 1**

SKU	Colors	Sizes						UOM
NOMJKTGH	Tan	S	M	L	XL	2X	3X	EA
<b>Price</b>		\$228.07	\$228.07	\$228.07	\$228.07	\$239.47	\$251.46	
NOMJKTGREY	Grey	S	M	L	XL	2X	3X	EA
<b>Price</b>		\$228.07	\$228.07	\$228.07	\$228.07	\$239.47	\$251.46	
NOMJKTNAVY	Navy Blue	S	M	L	XL	2X	3X	EA
<b>Price</b>		\$228.07	\$228.07	\$228.07	\$228.07	\$239.47	\$251.46	
NOMJKTROY	Royal Blue	S	M	L	XL	2X	3X	EA
<b>Price</b>		\$228.07	\$228.07	\$228.07	\$228.07	\$239.47	\$251.46	

### C. DuPont™ Nomex® IIIA Lab Coat

Nomex IIIA Aramid is inherently flame resistant for the life of the garment. The flame resistant properties will not wash or wear out. This lab coat is made out of 4.5 oz Nomex® IIIA brand fiber and sewn throughout with Nomex® thread. It is lightweight in comfort and features a 42" in length, lapel-style front, 2 large front pockets, and a left chest pocket. Made in United States. Available in royal blue, spruce green, gray, tan, orange and navy blue. Specify size S - 5XL. **Meets NFPA 2112 requirements. NFPA 70E, CAT 1**

SKU	Colors	Sizes						UOM
LAB1525NV	Navy Blue	S	M	L	XL	2X	3X	EA
<b>Price</b>		\$84.21	\$84.21	\$84.21	\$84.21	\$88.42	\$92.84	

**C**



**CAT 1** NFPA 2112

Available Colors

**CAT 2** NFPA 2112



**D**

Available Colors

### D. FR 9.5 oz Cotton Lab Coat

This 100% cotton lab coat containing flame resistant properties are guaranteed for the life of the garment if proper laundering instructions are followed. This lab coat is made out of 9.5 oz flame-resistant, 100% cotton fabric. Sewn throughout with Nomex® thread. It features 2 large front pockets, one left chest pocket and 42" in length. Made in USA. Available in royal blue, yellow, spruce green, gray, tan, orange and navy blue. Specify size S - 5XL. **Meets NFPA 2112 requirements. NFPA 70E, CAT 2**

SKU	Colors	Sizes						UOM
INDLABNVY	Navy Blue	S	M	L	XL	2X	3X	EA
<b>Price</b>		\$51.75	\$51.75	\$51.75	\$51.75	\$54.35	\$57.05	



**A**

### A. 12 CAL Kit #2 - Arcgear Head Protection, Coat & Leggings

CAT2 (8 cal/cm<sup>2</sup>) garments are made with WESTEX UltraSoft®. This lightweight and durable material FR treated fabric remains flame resistant for the useful life of the garment, assuming it is properly cleaned as instructed on item label.

- Dielectric hard cap with visor/adaptor, faceshield with chin cup
- 50" length coat, covered zipper front closure with storm flap, NOMEX® wristlets
- 2-ply stretch Knit CarbonX® HOOD with 1-ply cape
- 19" length leggings, VELCRO® closures and pull tab for quick removal
- Faceshield assembly bag
- Nylon Equipment bag
- Safety Glasses and Ear Plugs

WARNING: Once a garment has been exposed to an arc flash, it must be removed from service.

SKU	Sizes								UOM
STGAG12KIT	S	M	L	XL	2X	3X	4X	5X	KT
<b>Price:</b>	\$501.59	\$501.59	\$501.59	\$458.47	\$551.75	\$551.75	\$601.90	\$601.90	

### B. 25 CAL Kit #3 - Arcgear Hood With Air, Coat & Legging

CAT3 (25 cal/cm<sup>2</sup>) garments are made with a double layer WESTEX ULTRASOFT®. This lightweight and durable material FR treated fabric remains flame resistant for the useful life of the garment, assuming it is properly cleaned as instructed on item label.

- Hood, includes Patented Cooling System battery powered (8 'AA' batteries included), produces 80 cfm of air, for comfort in hot environments, decreases fogging of lens; replaceable tinted lens meets ANSI Z87.1, dielectric hard cap included
- 50" length coat, covered zipper front closure with storm flap, NOMEX® wristlets
- 19" length leggings, VELCRO® closures and pull tab for quick removal
- Hood/Lens bag
- Nylon Equipment bag
- Safety Glasses and Ear Plugs
- Hood may be used WITH or WITHOUT cooling system

WARNING: NFPA 70E Compliance requires wearing, of whole system (3 piece) as ONE UNIT.

WARNING: Once a garment has been exposed to an arc flash, it must be removed from service.

SKU	Sizes								UOM
STGAG25KIT	S	M	L	XL	2X	3X	4X	5X	KT
<b>Price:</b>	\$783.33	\$783.33	\$783.33	\$783.33	\$861.67	\$861.67	\$940.00	\$940.00	



**B**



**C**

### C. 40 CAL Kit #4 - Arcgear Hood With Air, Coat & Legging

CAT4 (40 cal/cm<sup>2</sup>) garments are made with NOMEX®IIIA and KEVLAR®. This lightweight material combination is inherently flame resistant. Following the proper care and cleaning instructions that are printed on the garment labels is essential in maintaining FR properties.

- Hood, includes Patented Cooling System battery powered (8 'AA' batteries included), produces 80 cfm of air, for comfort in hot environments, decreases fogging of lens; replaceable tinted lens meets ANSI Z87.1, dielectric hard cap included
- 50" length coat, covered zipper front closure with storm flap, NOMEX® wristlets
- 19" length leggings, VELCRO® closures and pull tab for quick removal
- Hood/Lens bag
- Nylon Equipment bag
- Safety Glasses and Ear Plugs
- Hood may be used WITH or WITHOUT cooling system

WARNING: NFPA 70E Compliance requires wearing, of whole system (3 piece) as ONE UNIT.

WARNING: Once a garment has been exposed to an arc flash, it must be removed from service.

SKU	Sizes								UOM
STGAG40K	S	M	L	XL	2X	3X	4X	5X	KT
<b>Price:</b>	\$944.38	\$944.38	\$944.38	\$944.38	\$1038.82	\$1038.82	\$1133.27	\$1133.27	



## A. Sellstrom ArcFlash™ Faceshield

Nothing but True Colors.... Protect yourself from low level arc flash hazards with our new arc flash faceshields. Featuring a specially formulated anti-fog window that provides excellent clarity and, most importantly, outstanding color definition; giving the user the best possible VISION and PROTECTION they need to perform their job. Meets ANSI Z87.1+-2003, ASTM F-2178-06 and NFPA 70E-2009 Standards.

SKU	Description	UOM	Price
SEL31200	Ratchet headgear, chin guard, poly. 9.9 cal anti-fog window	EA	\$79.09
SEL31201	Universal slot adapter, chin guard, poly. 9.9 cal anti-fog window	EA	\$79.78
SEL31220	Replacement 8"x15"x.060 polycarbonate 9.9cal anti-fog window	EA	\$52.69



## B. Arc Flash Balaclava and Kits



The **Medium Energy Balaclava** is an open face design giving one large port for the eyes making this comfortable to the wearer. The Medium Energy Balaclava is a soft double layer Kevlar blend fabric that is to be worn tucked into your PPE Arc Flash approved shirt or jacket. The **High Energy Balaclava** is a dual eye port design with a honey-comb breathing chamber. The High Energy Balaclava is a soft triple layer stretch Carbon-X fabric and is to be worn tucked into your PPE Arc Flash approved shirt or jacket.

SKU	Description	UOM	Price
PAUARCBALAHE	Arc Flash Balaclava high energy 45 Cal/cm2	EA	\$82.75
PAUARCBALAME	Arc Flash Balaclava medium energy 27 Cal/cm2	EA	\$57.93
<i>Arc Flash Energy Kits include the Arc Flash Balaclava and The ArcGoggle</i>			
PAUARCKITHE	High energy arc kit 45.8 Cal/cm2	EA	\$255.64
PAUARCKITME	Medium energy arc kit 27 Cal/cm2	EA	\$206.92

## C. Oilman PPE Duffel Bag

This durable 18oz vinyl PPE duffel bag has plenty of room for your PPE equipment needs. Included with this bag is 2 inside Velcro® dividers to make 3 distinct compartments or they can be removed for one large bag. The Oilman PPE Duffel Bag also features wrap tote straps, shoulder strap and front pocket.

SKU	Description	Color	UOM	Price
MSB74430NVY	Oilman PPE Duffel Bag 30"L x 12"W x 12"H	Navy	EA	\$29.98
MSB74430BLK	Oilman PPE Duffel Bag 30"L x 12"W x 12"H	Black	EA	\$29.98



## D. Deluxe Oilman PPE Duffel Bag

This durable 18oz vinyl PPE duffel bag has plenty of room for your PPE equipment needs. Included with this bag is 2 inside Velcro® dividers to make 3 distinct compartments or they can be removed for one large bag. The Deluxe Oilman PPE Duffel Bag also features wrap tote straps, shoulder strap, 600 Denier fabric front pocket, 2 side mesh pockets and zipper rain guard.

SKU	Description	Color	UOM	Price
MSB78424BLK	Deluxe Oilman PPE Duffel Bag 24"L x 12"W x 12"H	Black	EA	\$32.00



**A**

### A. Pyrolon® Plus 2 Flame Resistant Coverall

Pyrolon® Plus 2 has been thermal mannequin tested according to ASTM F1930. When worn over thermally protective coveralls, garments made of Pyrolon® Plus 2 can reduce predicted body burn injury. Meets the requirements of NFPA 2113, Standard on Selection, Care, Use, and Maintenance of Flame-Resistant Garments for Protection of Industrial Personnel Against Flash Fire. It offers strength, wet or dry, over other traditional FR disposable garments. It is breathable, making this a cool and comfortable garment to wear.

SKU	Description	Seams	Color	Size	UOM	Price
MSC7412B	Pyrolon secondary FR coverall	Serged	Light blue	S-XL	25/CS	\$136.77
MSC7412B2X	Pyrolon secondary FR coverall	Serged	Light blue	2XL	25/CS	\$143.61
MSC7412B3X	Pyrolon secondary FR coverall	Serged	Light blue	3XL	25/CS	\$152.22
MSC7412B4X	Pyrolon secondary FR coverall	Serged	Light blue	4XL	25/CS	\$163.64

### B. Pyrolon® CRFR

Pyrolon® CRFR protective wear is unique. It's disposable, chemical resistant, and flame-resistant, meeting NFPA 2113 requirements. Imagine all these qualities in one protective garment. Pyrolon® CRFR garments bar contaminating flammables like paint, oil, and grease, hazardous liquids, dry particulates, and other harmful contaminants from penetrating to inner clothing.

SKU	Description	Size	UOM	Price
MSC51150	Pyrolon CRFR 2ml grey, attached hood, elastic wrist, and booties	S-XL	6/CS	\$234.57
MSC511502X	Pyrolon CRFR 2ml grey, attached hood, elastic wrist, and booties	2X	6/CS	\$246.27
MSC511503X	Pyrolon CRFR 2ml grey, attached hood, elastic wrist, and booties	3X	6/CS	\$258.10
MSC51250	Pyrolon CRFR 2ml grey jacket, collar, elastic wrist, and storm flap	S-XL	6/CS	\$201.07
MSC512502XL	Pyrolon CRFR 2ml grey jacket, collar, elastic wrist, and storm flap	2X	6/CS	\$211.15
MSC512503XL	Pyrolon CRFR 2ml grey jacket, collar, elastic wrist, and storm flap	3X	6/CS	\$221.69
MSC512504XL	Pyrolon CRFR 2ml grey jacket, collar, elastic wrist, and storm flap	4X	6/CS	\$232.78
MSC512505XL	Pyrolon CRFR 2ml grey jacket, collar, elastic wrist, and storm flap	5X	6/CS	\$244.41
MSC51300	Pyrolon CRFR 2ml grey pant, elastic waist and ankles	S-XL	6/CS	\$207.55
MSC513002XL	Pyrolon CRFR 2ml grey pant, elastic waist and ankles	2X	6/CS	\$217.92
MSC513003XL	Pyrolon CRFR 2ml grey pant, elastic waist and ankles	3X	6/CS	\$228.84
MSC513004XL	Pyrolon CRFR 2ml grey pant, elastic waist and ankles	4X	6/CS	\$240.25
MSC513005XL	Pyrolon CRFR 2ml grey pant, elastic waist and ankles	5X	6/CS	\$252.26



**B**

MSC51150



### C. Aluminized Clothing

Aluminized clothing that has been designed for maximum protection in the most adverse work conditions. Steel mills, foundries and casting operations, to name a few, have job applications that require hand and body protection for temperatures that are high.

Hood features: 15 oz. Aluminized Rayon, swing open 7" x 11" LEXAN® facepiece, KEVLAR® thread sewn, Kwik-Klip and hard cap.

Glove features: 22 oz. Aluminized Thermonol back & thumb, 22 oz. Thermonol palm, 11 oz. wool lining, 14" length, clute cut, set in thumb style and KEVLAR® thread sewn.



35" Coat



Pants

**C**



Hood



Gloves

SKU	Colors	Sizes								UOM	
STG113635	Aluminized	S	M	L	XL	2X	3X	4X	5X	EA	
<b>Price: 35" Coat</b>		\$245.79	\$245.79	\$245.79	\$245.79	\$270.37	\$270.37	\$294.95	\$294.95		
STGATH410	Aluminized	S	M	L	XL	2X	3X	4X	5X	EA	
<b>Price: Pants</b>		\$263.86	\$263.86	\$263.86	\$263.86	\$290.25	\$290.25	\$316.63	\$316.63		
SKU	Description									UOM	Price
STGARL451A	Hood, 15 oz. Aluminized									EA	\$226.85
STGTH210-14F	High Heat Glove, 22 oz. Aluminized Thermonol back & thumb									PR	\$40.18



**A. Eclipse™**

Tingley's Eclipse is designed to meet the special demands of workers that may be exposed to momentary electric arc or flash fire hazards. Ideal Applications: All electric and gas utilities, power generation, pipeline, construction work, and petrochemical applications. The Eclipse features Overhead shoulder design for complete freedom of movement while working overhead, Therm-O-Rad sealed seams for 100% liquid proof protection and Flame resistant corduroy collar with roll-a-way hood for comfort and convenience. ANSI/ISEA 107 Class 3 compliant suit, jacket and coat for flame resistance and high visibility. Conforms to ASTM F1891 for Arc Thermal Performance and NFPA 70E - CAT 2. Jacket and overall styles conform to ASTM F2733 for Flash Fire Performance.

SKU	Colors	Sizes							UOM
TINGC44129	Orange	S	M	L	XL	2X	3X	4X	EA
<b>Price: Coat</b>		\$145.96	\$145.96	\$145.96	\$145.96	\$150.35	\$154.74	\$159.12	
TINGJ44129	Orange	S	M	L	XL	2X	3X	4X	EA
<b>Price: Jacket</b>		\$133.44	\$133.44	\$133.44	\$133.44	\$137.82	\$142.21	\$146.60	
TINGO44129	Orange	S	M	L	XL	2X	3X	4X	EA
<b>Price: Overall</b>		\$81.05	\$81.05	\$81.05	\$81.05	\$85.44	\$89.82	\$94.21	
TINGC44122	Lime	S	M	L	XL	2X	3X	4X	EA
<b>Price: Coat</b>		\$145.96	\$145.96	\$145.96	\$145.96	\$150.35	\$154.74	\$159.12	
TINGJ44122	Lime	S	M	L	XL	2X	3X	4X	EA
<b>Price: Jacket</b>		\$133.44	\$133.44	\$133.44	\$133.44	\$137.82	\$142.21	\$146.60	
TINGO44122	Lime	S	M	L	XL	2X	3X	4X	EA
<b>Price: Overall</b>		\$81.05	\$81.05	\$81.05	\$81.05	\$85.44	\$89.82	\$94.21	



**B. Electra™**

The combination of flame resistant PVC coating on non-woven Nomex provides excellent thermal performance and maintains 100% waterproof protection, in a soft, lightweight rainsuit. Conforms to ASTM F1891 for Arc Thermal Performance. ANSI/ISEA 107 Class 3 compliant suit, jacket, and coat for high visibility. Fluorescent background colors for excellent daytime visibility. 2" silver reflective trim reflects light for 360° nighttime conspicuity.

SKU	Colors	Sizes							UOM
TINGC42129	Orange	S	M	L	XL	2X	3X	4X	EA
<b>Price: Coat</b>		\$127.67	\$127.67	\$127.67	\$127.67	\$131.74	\$135.81	\$139.88	
TINGJ42129	Orange	S	M	L	XL	2X	3X	4X	EA
<b>Price: Jacket</b>		\$104.72	\$104.72	\$104.72	\$104.72	\$108.79	\$112.86	\$116.93	
TINGO42129	Orange	S	M	L	XL	2X	3X	4X	EA
<b>Price: Overall</b>		\$69.31	\$69.31	\$69.31	\$69.31	\$73.38	\$77.45	\$81.52	

**C. Comfort-Brite®**

Comfort-Brite® - The Ultimate General Purpose Rain Suit. Highly visible, flame resistant and loaded with special features, Comfort-Brite is lightweight, durable, and affordable. ANSI/ISEA 107 Class 3 compliant suit, jacket, and coat for high visibility. Flame resistant, self extinguishing with flameout and afterglow less than 2 seconds after removal of ignition source. Test method ASTM D6413. Loaded with special features for multipurpose applications. Fluorescent yellow-green background material for excellent daytime visibility. 2" silver reflective tape reflects light for 360° nighttime conspicuity.

SKU	Colors	Sizes							UOM
TINGC53122	Lime	S	M	L	XL	2X	3X	4X	EA
<b>Price: Coat</b>		\$62.28	\$62.28	\$62.28	\$62.28	\$63.74	\$63.74	\$63.74	
TINGJ53122	Lime	S	M	L	XL	2X	3X	4X	EA
<b>Price: Jacket</b>		\$46.88	\$46.88	\$46.88	\$46.88	\$48.35	\$48.35	\$48.35	
TINGO53122	Lime	S	M	L	XL	2X	3X	4X	EA
<b>Price: Overall</b>		\$21.62	\$21.62	\$21.62	\$21.62	\$23.09	\$23.09	\$23.09	







**A**

### A. Classic Series 49" Limited FR Coat

The FR200C yellow 49" long, 0.35mm PVC/polyester coat with welded seams features a black plastic snap storm fly front, black plastic take up snaps at the wrists, underarm air vents and 2 patch pocket of same material with flap with black plastic snaps. Limited flammability ASTM D6413 Standard.

SKU	Colors	Sizes									UOM
MSRFR200C	Yellow	S	M	L	XL	2X	3X	4X	5X	6X	EA
<b>Price</b>		\$9.75	\$9.04	\$9.04	\$9.04	\$9.42	\$9.79	\$10.18	\$10.61	\$9.75	

### B. Classic Plus Series 60" Limited FR Coat With Silver Reflective Stripes

The FR467CR black 60" long, 0.35mm PVC/polyester coat with welded seams features a black plastic snap storm fly front, black plastic take up snaps at the wrists, detachable hood, 2" reflective stripe above hem of coat and 2" reflective stripes around torso and arm sleeves. Limited flammability ASTM D6413 Standard.

SKU	Colors	Sizes								UOM
MSRFR267CR	Black	M	L	XL	2X	3X	4X	5X		EA
<b>Price</b>		\$24.28	\$24.28	\$24.28	\$25.25	\$26.28	\$27.35	\$28.46		



**B**



**C**

### C. Classic Plus Series 60" Limited FR Coat

The Classic Plus Series Material is the most popular in the Industry. It combines the strength and waterproof qualities of PVC with the durability of a polyester backing. The FR267C black Rider Coat is 60 inches in length, limited flammability, and features a detachable hood, snap front and take up snaps at the wrists. It has a corduroy lined collar for comfort and a cape ventilated back for air flow. Coat splits in the back and can snap around each leg to form chaps.

SKU	Colors	Sizes								UOM
MSR267FR	Black	M	L	XL	2X	3X	4X	5X		EA
<b>Price</b>		\$18.79	\$18.79	\$18.79	\$19.77	\$20.75	\$21.72	\$22.86		

### D. Wizard Limited FR Rainwear With Detachable Hood

These rain suits are versatile and can be used in many applications. The rain suits are constructed of a double coated PVC over 210 denier nylon. The clothing also has a special material that helps to prevent rips, snags and tears. Flame-retardant coating providing added protection to the wearer.

SKU	Colors	Sizes									UOM
MSR3003	Yellow	S	M	L	XL	2X	3X	4X	5X	EA	
<b>Price</b>		\$21.88	\$21.88	\$21.88	\$21.88	\$22.78	\$23.51	\$24.73	\$25.95		



**D**

### A. Anti-Static Modacrylic FR Class 2 Vest

This Anti-Static Modacrylic FR safety vest is intended for prevention of high visibility and FR hazards that also require anti-static resistance. Anti static properties are enhanced utilizing GlenGuard® Trilobal Carbon Fiber technology. Typical applications would be environments with flammable vapors, such as transferring flammable liquids, or other work environments that contain a flammable atmosphere. 3M Scotchlite FR Reflective Tape 8935 and Hook & Loop Closure. 94% FR Modacrylic, 5% Aramid, 1% Carbon Grid Anti-Stat. Meets ASTM F1506 and FTS 191A Method 5903. Fabric Certified to ANSI 107-2010 Level 2 and EN-471 Class 2 Retro Reflective Performance. EN-471 Class 2 Retro Reflective Performance.

SKU	Description	Color	Size	UOM	Price
MSV92ASG	Vest anti-static modacrylic FR class 2	Lime	M-XL	EA	\$69.55
MSV92ASG2X	Vest anti-static modacrylic FR class 2	Lime	2X	EA	\$76.50
MSV92ASG3X	Vest anti-static modacrylic FR class 2	Lime	3X	EA	\$83.34
MSV92ASG4X	Vest anti-static modacrylic FR class 2	Lime	4X	EA	\$90.42



### B. Basic Modacrylic FR Class 2 Vest

Radians Sport's Modacrylic FR safety vest is perfect when ultimate safety is required. Not only do these safety vests offer the flame resistant properties required by ANSI 107-2010, but also certified background and reflective material. They are perfect for the Utility Industry, or anywhere ultimate safety is required. 5.5 oz. 95% Modacrylic & 5% Twaron Material. 3M Scotchlite FR Reflective Tape 8935 and Hook & Loop Closure. Meets ASTM F1506 and FTS 191A Method 5903. Fabric Certified to ANSI 107-2010 Level 2 and EN-471 Class 2 Retro Reflective Performance. Meets & Exceeds NFPA 1971, 2000 Edition, Sections 5-1.4 and 6.2. ARC Rating 5.4 Cal/CM2.

SKU	Description	Color	Size	UOM	Price
MSV922VGSFR	Vest basic modacrylic FR class 2	Lime	M-XL	EA	\$64.79
MSV922VGSFR2	Vest basic modacrylic FR class 2	Lime	2X	EA	\$68.67
MSV922VGSFR3	Vest basic modacrylic FR class 2	Lime	3X	EA	\$72.52
MSV922VGSFR4	Vest basic modacrylic FR class 2	Lime	4X	EA	\$76.42
MSV922VGSFR5	Vest basic modacrylic FR class 2	Lime	5X	EA	\$80.27



### C. Economy Surveyor Flame Retardant Vest Class 2

Radians SV25 Economy Class 2 Self-Extinguishing Safety Vest with Zipper Closure is ANSI 107 Compliant SE protection at an economical price. Garment is made from polyester treated to be self-extinguishing as defined by ASTM D6413 (<2.0s flameout / <6" char length). This garment should never be used where an arc flash or flash fire hazard is present.

SKU	Description	Color	Size	UOM	Price
MSV25L	Heavy Duty Surveyor Class 2 vest	Lime	S-5X	EA	\$13.24
MSV25O	Heavy Duty Surveyor Class 2 vest	Orange	S-5X	EA	\$13.24



### D. Class 2 Flame Retardant Two-Tone Trim Vest

Radians SV225 Economy Class 2 Self-Extinguishing with Two-Tone Trim Safety Vest is ANSI 107 Compliant SE protection at an economical price. Garment is made from polyester treated to be self-extinguishing as defined by ASTM D6413 (<2.0s flameout / <6" char length). This garment should never be used where an arc flash or flash fire hazard is present.

SKU	Description	Color	Size	UOM	Price
MSV225G	Class 2 FR two-tone trim vest	Lime	M-5X	EA	\$12.25
MSV225O	Class 2 FR two-tone trim vest	Orange	M-5X	EA	\$12.33

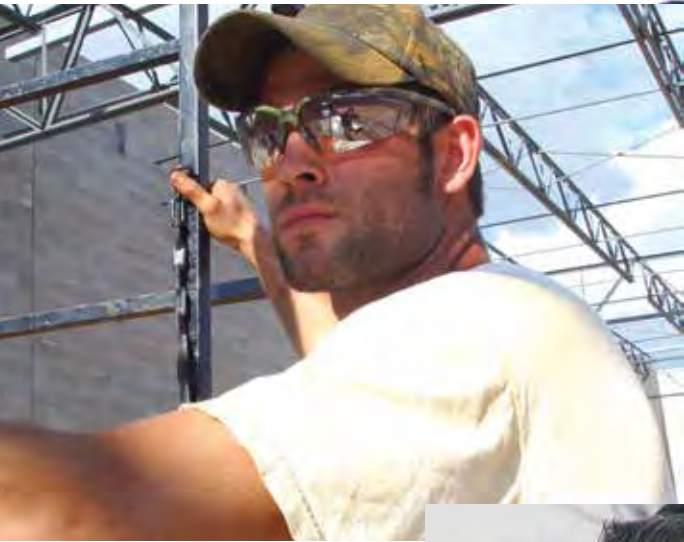

# Eye Protection







### A. Crossfire® RPG

The newly redesigned full frame RPG makes the list again as one of our best selling styles. Fitting a wide range of users, it is offered in various lens selections for application in diverse environments. Meets ANSI Z87 + standards.

SKU	Description	Lens	UOM	Price
CF23117	RPG crystal brown frame	HD Brown Flash Mirror	PR	\$7.49
CF23226	RPG matt black frame	HD Blue Mirror Polarized	PR	\$32.45
CF23615	RPG shiny pearl gray frame	Indoor/Outdoor	PR	\$7.84



CF23226



CF3463

### B. Crossfire® KP6

The newly designed KP6 features a sleek lightweight frame and makes an easy transition from safety in the workplace to safety in sporting activities. Meets ANSI Z87 + standards.

SKU	Description	Lens	UOM	Price
CF3463	KP6 shiny black frame	Silver Mirror	PR	\$6.98
CF34257	KP6 dark crystal brown frame	HD Brown Flash Mirror	PR	\$6.88
CF3441	KP6 crystal black frame	Smoke	PR	\$6.58

### C. Crossfire® ES4

Designed for all environments, the ES4 features an adjustable nosepiece, ultralight frame, and 100% visually correct lenses. Meets ANSI Z87 + standards.

SKU	Description	Lens	UOM	Price
CF2123	ES4 shiny black frame	Silver Mirror	PR	\$7.28
CF2141	ES4 crystal black frame	Smoke	PR	\$7.28
CF21427	ES4 crystal black frame	Silver Mirror Polarized	PR	\$32.45



CF2141



CF2968

### D. Crossfire® ES5

Designed for outdoor sports, the ES5 provides a polished style and is similar in design to Maui Jim. The sleek framework provides substantial coverage for a variety of environments. Meets ANSI Z87 + standards.

SKU	Description	Lens	UOM	Price
CF2968	ES5 black frame	Blue Mirror	PR	\$8.34
CF29117	ES5 brown frame	Brown Flash Mirror	PR	\$7.29
CF291113	ES5 brown frame	Brown Polarized	PR	\$31.03

### E. Crossfire® AR3

Designed for all environments, the AR3 features an adjustable nosepiece, ultralight frame, and 100% visually correct lenses. Meets ANSI Z87 + standards.

SKU	Description	Lens	UOM	Price
CF16144	AR3 woodland brown camouflage frame	Clear	PR	\$12.72



CF16144

# Eye Protection

## Safety Glasses



### A. Crossfire® Infinity

The full frame Infinity joins the list of one of top selling designs. The comfortable fit is easy wear all day and is offered in various options including polarized. Similar in comparison to Ray Ban. Meets ANSI Z87 + standards.

SKU	Description	Lens	UOM	Price
CF241	Infinity black frame	Smoke	PR	\$8.57
CF2812	Infinity orange/black frame	Gold Mirror	PR	\$10.08

### B. Crossfire® Core

The Core is among the top selling safety glasses for its performance in fit, function and style. This style is supported by a variety of lens choices as it performs well in outdoor and indoor use. Meets ANSI Z87 + standards.

SKU	Description	Lens	UOM	Price
CF18146	Core brown camo frame	Brown	PR	\$8.57
CF18171	Core green camo frame	Smoke	PR	\$8.57



### C. Crossfire® Sniper

Count on the Sniper to perform on the job. Designed with the sportsman in mind, this style transitions easily from a work environments to recreation! Meets ANSI Z87 + standards.

SKU	Description	Lens	UOM	Price
CF9117	Sniper brown frame	Brown Flash Mirror	PR	\$6.58
CF9141	Sniper brown camo frame	Brown	PR	\$8.72
CF91721	Sniper green camo frame	Green	PR	\$8.52

### D. Crossfire® Cobra

The Cobra is among the top selling design as it exhibits clean lines and diverse application. Meets ANSI Z87 + standards.

SKU	Description	Lens	UOM	Price
CF1583	Cobra orange frame	Silver Mirror	PR	\$7.23
CF15117	Cobra orange frame	Brown	PR	\$6.53





### A. DEWALT DPG54 - Protector™

The sleek design is a perfect fit for both men and women, ensuring worker compliance. Weighs less than 1 ounce allowing for all day comfort. Rubber tipped temples provide a secure and comfortable fit. Tough, polycarbonate lens is impact-resistant, distortion free, and provides 99.9% UV protection. Meets ANSI Z87.1+ eyewear requirements.

SKU	Description	Lens	UOM	Price
RADDPG54-1D	Protector	Clear	PR	\$2.53
RADDPG54-2D	Protector	Smoke	PR	\$3.07
RADDPG54-9D	Protector	Indoor/outdoor	PR	\$3.43



RADDPG54-1D

### B



RADDPG522

### B. DEWALT DPG52 Contractor Pro™

DEWALT's Contractor Pro™ Series offers more safety features at a great value without compromising style or comfort. The Rubber-tipped temples and Soft, rubber nosepiece offers a secure and more comfortable fit. The distortion free, polycarbonate lens provides impact resistance and 99.9% UV protection. Meets ANSI Z87.1+, CE, CSA & AS/NS standards.

SKU	Description	Lens	UOM	Price
RADDPG521	Contractor Pro	Clear	PR	\$2.70
RADDPG522	Contractor Pro	Smoke	PR	\$3.25
RADDPG529	Contractor Pro	Indoor/Outdoor	PR	\$3.43

### C. DEWALT DPG51 Radius™

The DEWALT Radius offers a 10 base curve lens which provides maximum coverage and protection. The DEWALT Radius features rubber tipped temples that provide a secure comfortable fit and a soft, rubber nosepiece that provides a non-slip, comfortable wear. The tough, polycarbonate lens provides impact resistance. DEWALT protective glasses meet or exceed ANSI Z87.1+ standards.

SKU	Description	Lens	UOM	Price
RADDPG51-1	Radius	Clear	PR	\$5.07
RADDPG51-2	Radius	Smoke	PR	\$5.62
RADDPG51-9	Radius	Indoor/Outdoor	PR	\$5.80



RADDPG51-9

### D



RADDPG94-GL

### D. DEWALT DPG94 Dominator™

The DEWALT Dominator - modern styling meets high impact protection. The rubber tipped temples provide a non-slip comfortable fit while the full frame with larger lens provides excellent coverage. The integrated rubber nosepiece provides longer, comfortable wear. Gradient lens option offers glare protection and visual clarity. Meets ANSI Z87.1+ standards.

SKU	Description	Lens	UOM	Price
RADDPG94-1D	Dominator	Clear	PR	\$4.70
RADDPG94-2D	Dominator	Smoke	PR	\$5.25
RADDPG94-9D	Dominator	Indoor/Outdoor	PR	\$5.43
RADDPG94-6D	Dominator	Silver Mirror	PR	\$5.62
RADDPG94-GLD	Dominator	Gradient	PR	\$5.62



# Eye Protection

## Safety Glasses



### TPR TECHNOLOGY

This material increases its "GRIP" as it becomes moist or warm to keep the glasses on your face.

### LENS TECHNOLOGY

Tapered lens to eliminate refraction. Lenses block 99.9% of UVA/UVB/UVC rays

Fog resistant and scratch resistant lenses

Polycarbonate lenses comply with ANSI Z87.1 + 2012 & MCEPS GL-PD 10-12

### FRAME TECHNOLOGY

Frames consist of a flexible & durable TR90/Nylon compound material.

Wrap around frame with no side shield distortion.

Straight temples that rest comfortably on your head and won't pinch.



EDGSWAP119

### A. Dakura

SKU	Description	Lens	UOM	Price
EDGSW114	Dakura gloss black nylon frame	Amber	PR	\$12.73
EDGSW111AR	Dakura gloss black nylon frame	Anti-reflective	PR	\$12.73
EDGSWAP119	Dakura gloss black nylon frame	Red mirror	PR	\$15.50
EDGSW117	Dakura gloss black nylon frame	Silver mirror	PR	\$12.73
EDGSW112	Dakura gloss black nylon frame	Yellow	PR	\$12.73
EDGSW111VS	Dakura gloss black nylon frame	Clear vapor shield	PR	\$22.87
EDGTSMAP218	Dakura gloss black nylon frame	Aqua blue polarized	PR	\$36.27
EDGTSM216CF	Dakura camouflage nylon frame	Smoke polarized	PR	\$36.27
EDGSW128	Dakura silver nylon frame	Blue Mirror	PR	\$12.73

### B. Brazeau

SKU	Description	Lens	UOM	Price
EDGXB115	Brazeau gloss black nylon frame	Copper	PR	\$16.17
EDGXB118	Brazeau gloss black nylon frame	Blue Mirror	PR	\$16.17
EDGTXBG216	Brazeau gloss black nylon frame	Gradient Polarized	PR	\$38.09
EDGXB111AR	Brazeau gloss black nylon frame	Anti-reflective	PR	\$16.17
EDGXB116	Brazeau gloss black nylon frame	Smoke	PR	\$16.17
EDGTXB236	Brazeau rubberized black nylon frame	Smoke polarized	PR	\$38.18
EDGXB136	Brazeau rubberized black nylon frame	Smoke	PR	\$19.04
EDGTXB246	Brazeau gloss white nylon frame	Smoke polarized	PR	\$38.18
EDGXB146	Brazeau gloss white nylon frame	Smoke	PR	\$19.04



EDGXB118



EDGTSK216

### C. Kazbek

SKU	Description	Lens	UOM	Price
EDGTSK215	Kazbek rubberized black nylon frame	Copper polarized	PR	\$36.27
EDGTSK216	Kazbek rubberized black nylon frame	Smoke polarized	PR	\$36.27
EDGTSKAP218	Kazbek rubberized black nylon frame	Blue mirror polarized	PR	\$36.27
EDGSDKAP119	Kazbek gloss silver gradient nylon frame	Aqua precision red mirror	PR	\$17.51
EDGSK116	Kazbek gloss silver gradient nylon frame	Smoke	PR	\$13.59
EDGSK117	Kazbek gloss silver gradient nylon frame	Silver mirror	PR	\$13.59

**ANTI-FOG RE-ENGINEERED**

**Uvex HydroShield™ Anti-Fog Coating**  
**60X LONGER LASTING**  
**Fog-Free Performance**

**CLEARER. LONGER. SAFER.**

\*Anti-Fog performance based on independent lab test results when compared to median test results of competitive anti-fog coated products under EN166 and EN16 testing standards. Competitive lens life test performed using a Bayer Abrasion Test method and may vary between environment and application.

## Uvex HydroShield Anti-Fog Coating

### 60X Longer-Lasting\* Fog-Free Performance

Foggy lenses are the number one challenge that users of safety eyewear face on the job. This revolutionary new lens coating is engineered to keep workers fog free for longer than ever before. HydroShield has been tested against dozens of competitive anti-fog coated products under the most rigorous anti-fog tests in the world. The results are groundbreaking.

**CLEARER. LONGER. SAFER.**

\*HydroShield was tested under the most stringent anti-fog standard in the world, the European EN 166/168 standard. Under this time-lapsed test, a lens is soaked in water for two hours to simulate the cumulative moisture lenses are subjected to over time from sweat, washing and work environments. After drying, steam is projected onto the lens and the time-to-fog is measured. During this test, HydroShield lenses remained fog-free 60X longer than competitive products (for over 2 minutes), while competitive products fogged in a median time of less than two seconds.

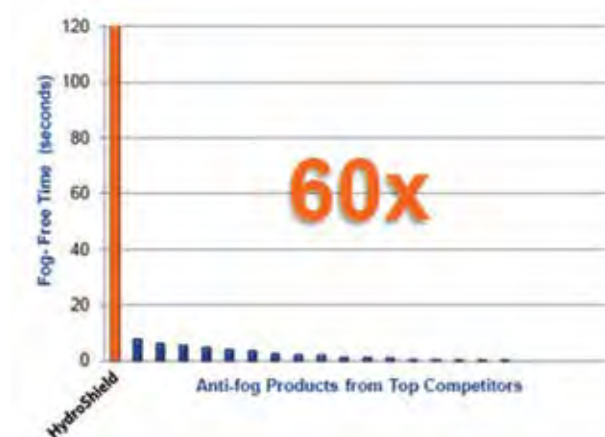



by Honeywell

### A. Uvex Genesis® Safety Glasses



Uvex Genesis combines cutting edge design with state-of-the-art molding technologies to deliver superior product benefits and a higher level of performance. Benefits include soft elastomeric browguard that cushions forehead and soft flexible nosepiece fingers. Lenses are coated with either Uvextreme® anti-fog coating, or Ultra-dura® enhanced chemical and scratch-resistant coating. The Uvex Genesis exceeds both ANSI Z87+ and CSA Z94.3 standards for impact protection. Made in USA. Meets military Vo ballistic test for impact. Lifetime frame guarantee.

SKU	Description	Frame	Lens	UOM	Price
S3200	Uvex Genesis	Black	Clear Ultra-Dura Anti-Scartch	PR	\$7.60
S3200HS	Uvex Genesis	Black	Clear HydroShield Anti-Fog	PR	\$9.04
S3200X	Uvex Genesis	Black	Clear Uvextreme Anti-fog	PR	\$8.18
S3201	Uvex Genesis	Black	Espresso Ultra-Dura Anti-Scartch	PR	\$8.36
S3201HS	Uvex Genesis	Black	Espresso HydroShield Anti-Fog	PR	\$13.13
S3201X	Uvex Genesis	Black	Espresso Uvextreme Anti-fog	PR	\$8.93
S3204	Uvex Genesis	Black	SCT-Reflect 50 Ultra-Dura Anti-Scartch	PR	\$9.53
S6900	Replacement lens		Clear Ultra-Dura Anti-Scartch	EA	\$3.20
S6900HS	Replacement lens		Clear HydroShield Anti-Fog	EA	\$5.73
S6900X	Replacement lens		Clear Uvextreme Anti-fog	EA	\$3.77
S6901	Replacement lens		Espresso Ultra-Dura Anti-Scartch	EA	\$3.98
S6901HS	Replacement lens		Espresso HydroShield Anti-Fog	EA	\$6.87
S6901X	Replacement lens		Espresso Uvextreme Anti-fog	EA	\$4.55
S6904	Replacement lens		SCT-Reflect 50 Ultra-Dura Anti-Scartch	EA	\$5.14

### B. Uvex Genesis XC® Safety Glasses

The all-in-one solution in protective eyewear, Genesis XC eyewear sets the standard for extra coverage and extra comfort on the job. Its design extends protection and offers more than 180 degrees of peripheral coverage. Additionally, its ergonomically balanced MMT — Multi-Material Technology® frame provides exceptional all-day comfort. With the Rx lens insert, it offers an alternative for workers requiring vision correction.



SKU	Description	Frame	Lens	UOM	Price
S3300	Uvex XC Genesis	Black	Clear Ultra-Dura Anti-Scartch	PR	\$8.18
S3300HS	Uvex XC Genesis	Black	Clear HydroShield Anti-Fog	PR	\$12.96
S3300X	Uvex XC Genesis	Black	Clear Uvextreme Anti-fog	PR	\$8.77
S3301	Uvex XC Genesis	Black	Espresso Ultra-Dura Anti-Scartch	PR	\$8.93
S3301HS	Uvex XC Genesis	Black	Espresso HydroShield Anti-Fog	PR	\$10.60
S3301X	Uvex XC Genesis	Black	Espresso Uvextreme Anti-fog	EA	\$9.53
S3302	Uvex XC Genesis	Black	SCT-Reflect 50 Ultra-Dura Anti-Scartch	EA	\$10.09
S6950	Replacement lens		Clear Ultra-Dura Anti-Scartch	EA	\$3.67
S6950HS	Replacement lens		Clear HydroShield Anti-Fog	EA	\$6.49
S6950X	Replacement lens		Clear Uvextreme Anti-fog	EA	\$4.26
S6951	Replacement lens		Espresso Ultra-Dura Anti-Scartch	EA	\$4.45
S6951HS	Replacement lens		Espresso HydroShield Anti-Fog	EA	\$7.53
S6951X	Replacement lens		Espresso Uvextreme Anti-fog	EA	\$5.04
S6952	Replacement lens		SCT-Reflect 50 Ultra-Dura Anti-Scartch	EA	\$5.61



### C. Uvex Protégé®

Designed with Floating Lens™ technology, an expandable wrap-around brow, soft temple tip pads and molded rubber nose pads. The Uvex Protégé provides workers with exceptional comfort and flexible style that weighs less than an ounce. Meets ANSI Z87+, CSA Z94.3 and Military VO ballistic test for impact.

SKU	Description	Frame	Lens	UOM	Price
S4200	Uvex Protégé	Metallic black	Clear Ultra-Dura Anti-Scartch	PR	\$4.50
S4200HS	Uvex Protégé	Metallic black	Clear HydroShield Anti-Fog	PR	\$7.36
S4200X	Uvex Protégé	Metallic black	Clear Uvextreme Anti-fog	PR	\$5.04
S4201	Uvex Protégé	Metallic black	Gray Ultra-Dura Anti-Scartch	PR	\$5.20
S4201HS	Uvex Protégé	Metallic black	Gray HydroShield Anti-Fog	PR	\$8.44
S4202	Uvex Protégé	Metallic black	Indoor/Outdoor Ultra-Dura Anti-Scartch	PR	\$6.29





by Honeywell

**A. Uvex Astrospec 3000®**

The original safety glass that set the bar for sport-styled protective eyewear. Constructed of a single panoramic polycarbonate lens with molded sideshields and browguard. Uvex Astrospec eyewear also features adjustable temples, patented adjustable lens inclination, universal nose bridge and a wide variety of lens tints. Select from spatula or Duoflex® temple styles. The Duoflex temples have soft cushions. Spatula temples are the standard flat style. Meets ANSI Z87+ and CSA Z94.3 standards. Meets military Vo ballistic test for impact. Lifetime frame guarantee. Made in USA.

SKU	Description	Temple	Frame	Lens	UOM	Price
S1359	Uvex Astrospec 3000	Spatula	Black	Clear Ultra-Dura Anti-Scartch	PR	\$6.37
S1369	Uvex Astrospec 3000	Duoflex	Black	Gray Ultra-Dura Anti-Scartch	PR	\$7.17
S535	Replacement lens			Clear Ultra-Dura Anti-Scartch	EA	\$2.08
S536	Replacement lens			Gray Ultra-Dura Anti-Scartch	EA	\$2.88



S1169



S2504

**B Uvex Astro OTG® 3001**

The Uvex Astro OTG® offer attractive OTG “Over-The-Glass” styling. Economical alternative to expensive safety prescription eyewear. Large enough to fit over most prescription spectacles. Same features as the Uvex Astrospec 3000®. Meets ANSI Z87+. Lifetime frame guarantee. Made in USA.

SKU	Description	Frame	Lens	UOM	Price
S2500	Uvex Astro OTG	Black	Clear Ultra-Dura Anti-Scartch	PR	\$7.95
S2500C	Uvex Astro OTG	Black	Clear Uvextreme Anti-fog	PR	\$8.54
S2504	Uvex Astro OTG	Black	Gray Ultra-Dura Anti-Scartch	PR	\$8.75
S560	Replacement lens		Clear Ultra-Dura Anti-Scartch	PR	\$3.66
S562	Replacement lens		Gray Ultra-Dura Anti-Scartch	PR	\$4.45

**C. Uvex Ambient™ OTG**

The Uvex Ambient provides over-the-glass coverage, offering your workers full protection while wearing their own prescription eyewear. Available with a range of comfort features and in two sizes, the Uvex Ambient OTG offers all-day coverage for a variety of workers and a wide range of prescription eyewear styles. Meets ANSI Z87+ and CSA Z94.3.

SKU	Description	Lens	UOM	Price
S3150	Uvex Ambient OTG	Clear Ultra-Dura Anti-Scartch	PR	\$7.92
S3152	Uvex Ambient OTG	Smoke Ultra-Dura Anti-Scartch	PR	\$8.72



S3150



A011798

**D. 3M™ Virtua™ Sport CCS Protective Eyewear**

Protective eyewear with a Corded Earplug Control System (CCS). This unique temple design controls and holds the cord of the earplug to keep it securely in place and untangled while in use. The CCS is convenient for workers who are intermittently exposed to noisy areas; when earplugs are not in use the CCS helps prevent the loss of the hearing protector. The CCS feature also allows the corded earplugs to dual as a lanyard - a cord worn around the neck for carrying your protective eyewear. Comfortable, lightweight frame. Clear/gray anti-fog or hard-coat lens. Polycarbonate lens absorbs 99.9% UV. Meets the requirements of ANSI Z87.1-2003

SKU	Description	Lens	UOM	Price
A011797	Virtua Sport CCS	Clear H/C	PR	\$4.18
A011799	Virtua Sport CCS	Grey H/C	PR	\$4.18

**WARNING!**

These eye and face protection products help provide limited eye and face protection. Misuse or failure to follow warnings and instructions may result in serious potential injury, including blindness or death. For proper use, selection, and applications against flying particles, optical radiation and / or splash see supervisor, read User Instructions and warnings on the package or call 3M OH&ESD Technical Service in the USA at 1-800-243-4630. In Canada, call 1-800-267-4414.





**A**



RADCS1-20

### A. Chaos™

Chaos™ Eye Protection features original, modern styles that integrate the compliance and comfort elements end users demand from a safety glass. Other features include a sleek, lightweight full frame glass, available in black or mocha frame colors, bayonet style temples with rubber tips for superior comfort, integrated rubber nosepiece for all day comfort and loop tag included for easy product identification. Meets ANSI Z87.1+ standards and provides 99.9% UVA/UVB protection.

SKU	Description	Frame	Lens	UOM	Price
RADCS1-10	Chaos	Black	Clear	PR	\$4.07
RADCS1-20	Chaos	Black	Smoke	PR	\$4.44
RADCS1-60	Chaos	Black	Silver Mirror	PR	\$4.99

### B. Voltage™

Voltage™ Eye Protection features original, modern styles that integrate the compliance and comfort elements end users demand from a safety glass. Other features include modern style with black and silver frame choices with new electric blue and electric orange lens options, sleek, lightweight full frame glass, non-slip grip-on temples are dual molded into frame for maximum comfort, Polycarbonate lens for impact resistance, integrated rubber nosepiece for all day comfort and loop tag included for easy product identification. Meets ANSI Z87.1+ standards and provides 99.9% UVA/UVB protection.

SKU	Description	Frame	Lens	UOM	Price
RADVT1-10	Voltage	Black	Clear	PR	\$4.80
RADVT1-20	Voltage	Black	Smoke	PR	\$4.65
RADVT1-63	Voltage	Black	Electric Blue	PR	\$6.27
RADVT1-65	Voltage	Black	Electric Orange	PR	\$6.27
RADVT1-90	Voltage	Black	Indoor/Outdoor	PR	\$4.99



RADVT1-63

**B**



RADVT1-20

**C**



RADTT0120ID

### C. Titan™

Sporty wraparound look with great protection. Ultra lightweight safety glasses with monochromatic color scheme. Scratch-resistant hard coat protects lens and maintains optical clarity. Lenses provide 99.9% UVA and UVB protection. Meets ANSI Z87.1-2003 eyewear requirements as high impact protectors.

SKU	Description	Lens	UOM	Price
RADTT0110ID	Titan	Clear	PR	\$2.03
RADTT0120ID	Titan	Smoke	PR	\$2.57
RADTT0140ID	Titan	Amber	PR	\$2.72
RADTT0190ID	Titan	Indoor/Outdoor	PR	\$3.40

### D. Journey™

9.75 base lens provides excellent optics and coverage. Rubber nosepiece allows for all day comfort. 4-position telescoping temples offer superior fit. Scratch-resistant hard coat protects lens and maintains optical clarity. Lenses provide 99.9% UVA and UVB protection. Meets ANSI Z87.1-2003 eyewear requirements as high-impact protectors. Meets military V0 ballistic impact test (protection against impact energies 7x higher than ANSI requirements).

SKU	Description	Frame	Lens	UOM	Price
RADJR0110ID	Journey	Black	Clear	PR	\$1.65
RADJR0111ID	Journey	Black	Clear anti-fog	PR	\$2.20
RADJR0120ID	Journey	Black	Smoke	PR	\$1.73
RADJR0130ID	Journey	Black	IRUV 3.0	PR	\$6.43
RADJR0140ID	Journey	Black	Amber	PR	\$1.73
RADJR0150ID	Journey	Black	IRUV 5.0	PR	\$5.88
RADJR0170ID	Journey	Black	Blue mirror	PR	\$3.25
RADJR0190ID	Journey	Black	Indoor/outdoor	PR	\$2.08

**D**



RADJR0170ID



### A. Mirage™

Economical dual wraparound 9.75 base lens provides near perfect orbital seal. Sleek design allows for a perfect fit for both men and women, ensuring worker acceptance. Weighs less than 1 ounce. Lenses provide 99.9% UVA and UVB protection. Scratch-resistant hard coat protects lens and maintains optically correct and distortion free use. Meets ANSI Z87.1-2003 eyewear requirements as high impact protectors.

SKU	Description	Temple	Lens	UOM	Price
RADMR0110ID	Mirage		Clear	PR	\$1.25
RADMR0111ID	Mirage		Clear anti-fog	PR	\$1.98
RADMR0120ID	Mirage		Smoke	PR	\$1.25
RADMR0121ID	Mirage		Smoke anti-fog	PR	\$1.98
RADMR0140ID	Mirage		Amber	PR	\$1.25
RADMR01B0ID	Mirage		Light Blue	PR	\$1.98
RADMR0160ID	Mirage		Silver mirror	PR	\$2.10
RADMR0190ID	Mirage		Indoor/outdoor	PR	\$1.75
RADMR0191ID	Mirage		In/Out anti-fog	PR	\$2.27
RADMR01R0ID	Mirage		Rainbow mirror	PR	\$1.98
RADMRS110ID	Mirage small		Clear	PR	\$1.32
RADMRR110ID	Mirage RT	Rubber Tips	Clear	PR	\$1.62
RADMRR111ID	Mirage RT	Rubber Tips	Clear anti-fog	PR	\$2.32
RADMRR120ID	Mirage RT	Rubber Tips	Smoke	PR	\$1.98
RADMRR190ID	Mirage RT	Rubber Tips	Indoor/outdoor	PR	\$2.32



**A**

RADMR0120ID



RADMR0110ID

### B. Revelation™

The 5-position ratchet plus 4-position telescoping temples create superior fit. Soft, non-slip rubber nosepiece with self-adjusting fingers. Ventilation channel between lens and frame helps reduce fogging. Scratch-resistant hard coat protects lens and maintains optical clarity. Lenses provide 99.9% UVA and UVB protection. Meets ANSI Z87.1-2003 eyewear requirements as high-impact protectors.

SKU	Description	Frame	Lens	UOM	Price
RADRV0110ID	Revelation	Black	Clear	PR	\$3.00
RADRV0111ID	Revelation	Black	Clear anti-fog	PR	\$4.20
RADRV0120ID	Revelation	Black	Smoke	PR	\$3.47
RADRV0121ID	Revelation	Black	Smoke anti-fog	PR	\$4.70
RADRV0190ID	Revelation	Black	Indoor/outdoor	PR	\$4.30
RADRV0191ID	Revelation	Black	Indoor/outdoor AF	PR	\$5.23
RADRV01N0ID	Revelation	Black	Orange	PR	\$4.02

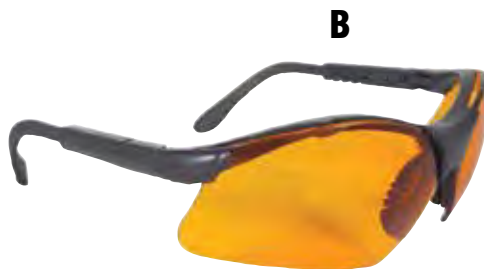

RADRV01N0ID

### C. Rad-Sequel™

Rubber tipped temples provide a secure fit. The soft, rubber nosepiece provides all day comfort. Features a lightweight design that provides a comfortable fit. While the polycarbonate lens provides impact resistance. Meets ANSI Z87.1+ standards and provides 99.9% UVA & B protection.

SKU	Description	Lens	UOM	Price
RADRS110	Rad-Sequel	Clear	PR	\$1.70
RADRS111	Rad-Sequel	Clear anti-fog	PR	\$2.25
RADRS120	Rad-Sequel	Smoke	PR	\$1.90
RADRS1B	Rad-Sequel	Light blue	PR	\$1.90
RADRS190	Rad-Sequel	Indoor/outdoor	PR	\$2.25
RADRS160	Rad-Sequel	Silver mirror	PR	\$2.25



RADRS1B



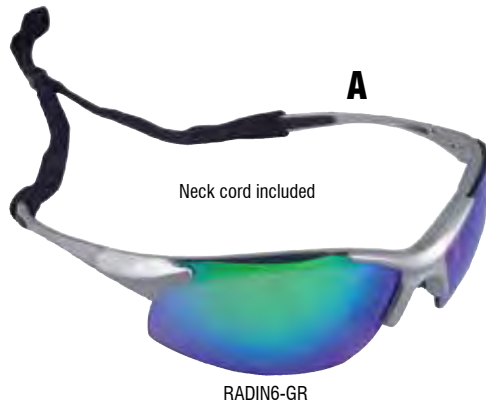

### A. Rad-Infinity™

Sleek sporty wraparound. Cushioned non-slip rubber temple pads for superior comfort. The rubber nosepiece allows for all day comfort. Comes with standard neckcord. Lenses are coated for scratch resistance. Meets ANSI Z87.1+ standards and provides 99.9% UVA & B protection.

SKU	Description	Frame	Lens	UOM	Price
RADIN1-10	Rad-Infinity	Black	Clear	PR	\$4.06
RADIN1-20	Rad-Infinity	Black	Smoke	PR	\$4.41
RADIN1-90	Rad-Infinity	Black	Indoor/outdoor	PR	\$4.59
RADIN2-70	Rad-Infinity	Blue	Blue mirror	PR	\$5.14
RADIN6-GR	Rad-Infinity	Silver	Green mirror	PR	\$5.14

### B. Rad-Apocalypse™

These sleek, sporty style glasses have soft, rubber temples and a neck cord. Provides 99.9% UV protection. Meets ANSI Z87.1+ standards.

SKU	Description	Frame	Lens	UOM	Price
RADAP1-10	Rad-Apocalypse	Clear	PR	\$3.23	
RADAP1-20	Rad-Apocalypse	Smoke	PR	\$3.58	
RADAP1-90	Rad-Apocalypse	Indoor/Outdoor	PR	\$3.58	

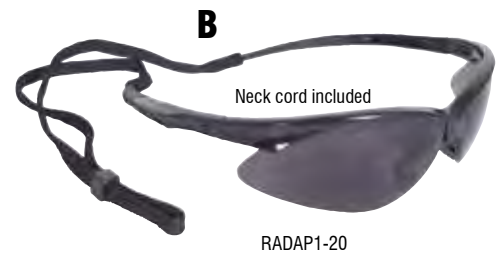

### C. Sonar™

The Radians Sonar™ has a sleek, lightweight design with non-slip rubber temples for maximum comfort. Other features include soft, rubber nosepiece provides all day comfort. Wrap-around single lens provides an unobstructed field of vision. Sleek, lightweight design offers a comfortable fit. Polycarbonate lens provides impact resistance and meets ANSI Z87.1+ standards and provides 99.9% UV protection.

SKU	Description	Frame	Lens	UOM	Price
RADSO1-10	Sonar™	Clear	PR	\$1.92	
RADSO1-20	Sonar™	Smoke	PR	\$2.27	
RADSO1-90	Sonar™	IN/Outdoor	PR	\$2.37	

### D. Cobalt™

Safety eyewear with lightweight frames combine style and 99.9% UVA and UVB protection. Wraparound design fits snugly to provide excellent orbital protection. Scratch-resistant hard coat protects lens and maintains optical clarity. Meets ANSI Z87.1-2003 eyewear requirements as high-impact protectors.

SKU	Description	Frame	Lens	UOM	Price
RADCB0110	Cobalt	Black	Clear	PR	\$2.52
RADCB01POID	Cobalt	Black	Polarized	PR	\$7.53





### A. 8650 Strike Force II™

The Strike Force II safety glass feature soft rubber nosepiece and a contemporary wraparound style. The lens are 7 base and have a hard coating. The rubber temple pads provide a non-slip fit. Meets ANSI Z87.1+ standards and provides 99.9% UVA & UVB protection.

SKU	Description	Frame	Lens	UOM	Price
RADE8650-C	Strike Force II	Black	Clear	PR	\$3.13
RADE8650-S	Strike Force II	Black	Smoke	PR	\$3.33
RADE8650-A	Strike Force II	Black	Amber	PR	\$3.33



RADE8650-S

B



RADAT1-20

### B. Rad-Atac™

Lightweight, popular style with soft, non-slip rubber tipped temples and integrated nosepiece. The wraparound single lens blocks 99.9% of harmful UV rays. Meets ANSI Z87.1-2003 eyewear requirements as high impact protectors.

SKU	Description	Lens	UOM	Price
RADAT1-10	Rad-Atac	Clear	PR	\$1.37
RADAT1-11	Rad-Atac	Clear anti-fog	PR	\$1.92
RADAT1-20	Rad-Atac	Smoke	PR	\$1.72
RADAT1-21	Rad-Atac	Smoke anti-fog	PR	\$2.03
RADAT1-40	Rad-Atac	Amber	PR	\$1.37
RADAT1-60	Rad-Atac	Mirror	PR	\$1.98
RADAT1-70	Rad-Atac	Blue Mirror	PR	\$1.98
RADAT1-90	Rad-Atac	Indoor/outdoor	PR	\$1.75
RADAT1-B	Rad-Atac	Light blue	PR	\$1.37

### C. G4™

The highly protective one-piece lens design offers integral side shields and extended brow guard protection for maximum safety. Glasses feature 5-position ratcheting temples with telescoping earpieces for a completely customized fit. Lenses provide 99.9% UVA and UVB protection. Scratch-resistant hard coat protects lens and maintains optical clarity. Meets ANSI Z87.1-2003 eyewear requirements as high-impact protectors.

SKU	Description	Frame	Lens	UOM	Price
RADG40110ID	G4	Black	Clear	PR	\$1.48
RADG40120ID	G4	Black	Smoke	PR	\$1.92



RADG40120ID

D



RADOTGSH6-90

### D. Sheath™

The Radians Sheath™ OTG Fits over most prescription glasses it features telescoping temples for a customized and comfortable fit, ratcheting temples provide lens angle adjustment for a perfect fit and polycarbonate lens provides impact resistance. All of Radians glasses are produced in ISO Certified facilities. They meet or exceed ANSI Z87.1 + standards and many styles have also been evaluated to Canadian Standards.

SKU	Description	Lens	UOM	Price
RADOTGSH1-20	Sheath™ OTG	Smoke	PR	\$3.52
RADOTGSH6-10	Sheath™ OTG	Clear	PR	\$2.91
RADOTGSH6-11	Sheath™ OTG	Clear AF	PR	\$3.68

### E. Chief™ (Visitor Specs)

Traditional looking safety glasses offering outstanding vision protection. Can be worn over prescription glasses. Close fitting design with integrally molded brow guard and deep side shields provides all around protection. Reinforced side shields provide high-impact lateral protection. Lenses provide 99.9% UVA and UVB protection. Meets ANSI Z87.1-2003 eyewear requirements as high-impact protectors. Evaluated to Canadian safety requirements.

SKU	Description	Frame	Lens	UOM	Price
RAD360C	Visitor Specs	Clear	Clear	PR	\$1.25



RAD360C



### A. C2™ Bifocal Safety Glasses

Radians C2™ series combines safety glasses with reading glasses to provide the best protection at an economical price without compromising style and comfort. The magnification diopter, available in five different strengths, is molded into the impact resistant polycarbonate lens. The durable scratch resistant hard coated lenses comply with ANSI Z87+ high impact performance standards and provide 99.9% UVA and UVB protection.



RADC2-1XX

SKU	Description	Lens	UOM	Price
RADC2-110	C2	1.0 Clear	PR	\$6.20
RADC2-115	C2	1.5 Clear	PR	\$6.20
RADC2-120	C2	2.0 Clear	PR	\$6.20
RADC2-125	C2	2.5 Clear	PR	\$6.20
RADC2-130	C2	3.0 Clear	PR	\$6.20
RADC2-210	C2	1.0 Smoke	PR	\$6.52
RADC2-215	C2	1.5 Smoke	PR	\$6.52
RADC2-220	C2	2.0 Smoke	PR	\$6.52
RADC2-225	C2	2.5 Smoke	PR	\$6.52
RADC2-230	C2	3.0 Smoke	PR	\$6.52

### B. Rad-Sequel RSx™ Bifocal Safety Glasses

Radians Rad-Sequel RSx™ series combines safety glasses with reading glasses to provide the best protection at an economical price without compromising style and comfort. The magnification diopter, available in five different strengths, is molded into the impact resistant polycarbonate lens. Features cushioned non-slip rubber temple pads for a secure grip. The durable scratch resistant hard coated lenses comply with ANSI Z87+ high impact performance standards and provide 99.9% UVA and UVB protection.

SKU	Description	Lens	UOM	Price
RADRSB-110	Clear Frame	Clear 1.0	PR	\$4.53
RADRSB-115	Clear Frame	Clear 1.5	PR	\$4.53
RADRSB-120	Clear Frame	Clear 2.0	PR	\$4.53
RADRSB-125	Clear Frame	Clear 2.5	PR	\$4.53
RADRSB-415	Coffee Frame	Coffee 1.5	PR	\$4.78
RADRSB-420	Coffee Frame	Coffee 2.0	PR	\$4.78
RADRSB-425	Coffee Frame	Coffee 2.5	PR	\$4.78



RADRSB-4XX

### C. Cheaters™ Bifocal Safety Glasses with Ratchet Temples

Reading safety glasses with lightweight nylon frame. Combines protective safety glasses with reading glasses. Cushioned, non-slip rubber temple pads for superior comfort. 5-Point ratcheting temples allows user to adjust bifocals for an optimal fit. Magnification diopter is molded into the polycarbonate lens that block 99.9% UV rays. High tech vented rubber nose piece. Free protective eyeglass sleeve included. Meets ANSI Z87.1-2003 eyewear requirements as high-impact protectors.

SKU	Description	Lens	UOM	Price
RADCH1-110	Cheaters	1.0 Clear	PR	\$8.75
RADCH1-115	Cheaters	1.5 Clear	PR	\$8.75
RADCH1-120	Cheaters	2.0 Clear	PR	\$8.75
RADCH1-125	Cheaters	2.5 Clear	PR	\$8.75
RADCH1-130	Cheaters	3.0 Clear	PR	\$8.75
RADCH1-215	Cheaters	1.5 Smoke	PR	\$9.17
RADCH1-220	Cheaters	2.0 Smoke	PR	\$9.17
RADCH1-225	Cheaters	2.5 Smoke	PR	\$9.17
RADCH1-915	Cheaters	1.5 Indoor/outdoor	PR	\$9.17
RADCH1-920	Cheaters	2.0 Indoor/outdoor	PR	\$9.17
RADCH1-925	Cheaters	2.5 Indoor/outdoor	PR	\$9.17



RADCH1-1XX





### A. Dagger™

The replaceable polycarbonate lens provides impact resistance. Made with foam padding that provides a perfect seal. Features a clip attachment for easy lens and temple replacement and an elastic head strap. The snap-in temples allow interchanging from ratcheting, telescoping temples to the head strap. Meets or exceeds ANSI Z87.1 + standards.

SKU	Description	Lens	UOM	Price
RADDG1-11	Dagger	Clear anti-fog	PR	\$7.18
RADDG1-21	Dagger	Smoke anti-fog	PR	\$7.65
RADDG1-91	Dagger	Indoor/outdoor	PR	\$7.65



RADDG1-11

### B



RADCT1-61

### B. Cuatro™ Foam Lined/Bi-Focal

Radians Cuatro™ 4-in-1 foam lined safety eyewear. Closed cell foam insert protects against airborne dust and debris. The Cuatro features: removable head strap provides an adjustable goggle-like fit, eyewear temples easily snap-in, anti-fog polycarbonate lens provides impact resistance and fog control, rubber nosepiece for all day comfort. Meets ANSI Z87.1+ standards and provides 99.9% UVA & UVB protection.

SKU	Description	Lens	UOM	Price
RADCT1-11	Cuatro foam lined safety glasses with anti-fog	Clear	PR	\$7.35
RADCT1-21	Cuatro foam lined safety glasses with anti-fog	Smoke	PR	\$7.70
RADCT1-61	Cuatro foam lined safety glasses with anti-fog	Mirror	PR	\$8.05
RADCT1-91	Cuatro foam lined safety glasses with anti-fog	Indoor/Outdoor	PR	\$8.05
RADCTB1-115	Cuatro foam lined safety bi-focal glasses with anti-fog	Clear 1.5	PR	\$11.38
RADCTB1-120	Cuatro foam lined safety bi-focal glasses with anti-fog	Clear 2.0	PR	\$11.38
RADCTB1-125	Cuatro foam lined safety bi-focal glasses with anti-fog	Clear 2.5	PR	\$11.38
RADCTB2-115	Cuatro foam lined safety bi-focal glasses with anti-fog	Smoke 1.5	PR	\$11.92
RADCTB2-120	Cuatro foam lined safety bi-focal glasses with anti-fog	Smoke 2.0	PR	\$11.92
RADCTB2-125	Cuatro foam lined safety bi-focal glasses with anti-fog	Smoke 2.5	PR	\$11.92

### C. Mirage™ Foam

Foam lined safety eyewear designed to block debris, airborne particles and eye irritants.

Features:

- Closed cell foam construction for extra protection from debris
- Full wraparound frame allows for unobstructed peripheral vision
- Foam lined pockets/vents provide extra fog control
- Polycarbonate lens provides impact protection

SKU	Description	Frame	Lens	UOM	Price
RADMRF111ID	Mirage Foam	Clear	Clear	PR	\$2.87
RADMRF121ID	Mirage Foam	Smoke	Smoke	PR	\$3.23
RADMRF191ID	Mirage Foam	Indoor/Outdoor	Indoor/Outdoor	PR	\$3.58



RADMRF191ID



### D



RADDPG95-2D

### D. DEWALT DPG95 Framework™

The DEWALT Framework™ features a closed all foam padding that provides a soft comfortable seal and protects against debris. The soft, rubber nosepiece provides a comfortable fit and the distortion free lens reduces eye fatigue. The clip attachment and snap-off temples allow you to change from temple pieces that have rubber temple pads to ensure a secure fit to an elastic head strap that provides an adjustable secure fit. Meets ANSI Z87.1 + standards.

SKU	Description	Lens	UOM	Price
RADDPG95-1D	Framework	Clear	PR	\$8.35
RADDPG95-11D	Framework	Clear A/F	PR	\$9.07
RADDPG95-2D	Framework	Smoke	PR	\$9.07
RADDPG95-9D	Framework	Indoor/Outdoor	PR	\$9.43



by Honeywell



S2600XP

### A. Uvex Livewire™ Sealed Eyewear

Uvex Livewire delivers the fit, performance and protection required in extreme environments, protecting workers against intense wind, sun, dirt, dust and debris, as well as high heat and humidity. Uvex Livewire features Uvextreme Plus® anti-fog lens coating for superior, long-lasting fog-free vision that lasts up to 10X longer, and provides 2X better scratch-resistance than competitive antifog coated products, with a simple temple-to-headband exchange system that makes switching between temples or headband quick and easy

SKU	Description	Lens	UOM	Price
S2600XP	Uvex Livewire sealed eyewear	Clear Uvextreme Plus AF	PR	\$14.17
S2600HS	Uvex Livewire sealed eyewear	Clear HydroShield Anti-Fog	PR	\$16.42
S2601XP	Uvex Livewire sealed eyewear	Espresso Uvextreme Plus AF	PR	\$14.25
S2601HS	Uvex Livewire sealed eyewear	Espresso HydroShield Anti-Fog	PR	\$16.51
S2602XP	Uvex Livewire sealed eyewear	Amber Uvextreme Plus AF	PR	\$14.40
S2604XP	Uvex Livewire sealed eyewear	SCT-Ref 50 Uvextreme Plus AF	PR	\$14.66

### B. Uvex Seismic™ Sealed Eyewear/Bi-Focal

Uvex Seismic sealed eyewear...powerful eyewear for today's demanding work environments. The Uvex Seismic provides protection against impact, sun, wind, dust and debris coupled with durable performance and minimized fogging. Its contemporary design offers a range of comfort and adjustability features for all-day wear as well as popular black and contemporary metallic-blue colored frame options. The Uvex Seismic eyewear comes with removable temples headband and replaceable cushioned subframe. Available with Uvextreme® anti-fog, Ultra-dura® anti-scratch coatings. Meets ANSI Z87+ and CSA Z94.3 (with cushioned sub-frame only).

SKU	Description	Lens	UOM	Price
S0600	Uvex Seismic Black	Clear Ultra-Dura Anti-Scartch	PR	\$12.01
S0600X	Uvex Seismic Black	Clear Uvextreme Anti-fog	PR	\$12.71
S0601X	Uvex Seismic Black	Espresso Uvextreme Anti-fog	PR	\$12.71
S0604X	Uvex Seismic Black	SCT-Ref. 50 Uvextreme Anti-fog	PR	\$13.71
S0661X	Uvex Seismic Black with Bifocal Lens 1.5	Clear Uvextreme Anti-fog	PR	\$14.97
S0662X	Uvex Seismic Black with Bifocal Lens 2.0	Clear Uvextreme Anti-fog	PR	\$14.97
S0663X	Uvex Seismic Black with Bifocal Lens 2.5	Clear Uvextreme Anti-fog	PR	\$14.97



S0600



S0601X



CF3541

### C. Crossfire® 710 Foamed Lined Eyewear

The EVA foam lined safety glass has the EVA foam lined safety glass has lightweight, full frame that protects against dust and debris. The dual mold rubber temples and soft, rubber nosepiece provides a comfortable, non-slip fit.

SKU	Description	Lens	UOM	Price
CF35117	710 Foamed Lined Eyewear Crystal Brown Frame	Brown AF	PR	\$11.24
CF35231	710 Foamed Lined Eyewear Black Frame	Indoor/Outdoor AF	PR	\$12.27
CF3541	710 Foamed Lined Eyewear Crystal Black Frame	Smoke AF	PR	\$11.24
CF3564	710 Foamed Lined Eyewear Pearl Gray Frame	Clear AF	PR	\$11.24

### D. Pyramex I-Force

Sporty, lightweight design eliminates the bulkiness and weight of a goggle. The outside and inside of the lens is coated with H2X™ Anti-fog Technology for even more resistance to fogging, due to extreme temperatures. Vented foam carriage provides maximum dust protection, as well as a sufficient airflow outlet for heat. Lenses provide 99% protection against harmful UV rays. Exceeds ANSI/ISEA Z87.1, meets MCEP GL-PD 10-12 Ballistic Standards. Meets CAN/CSA Z94.3-07 Standards, CE EN166 Certified.

SKU	Description	UOM	Price
PYRSB7010SDT	I-Force Eyewear Anti-Fog Clear Lens	EA	\$17.46
PYRSB7020SDT	I-Force Eyewear Anti-Fog Gray Lens	EA	\$17.89
PYRSB7030SDT	I-Force Eyewear Anti-Fog Amber Lens	EA	\$17.89
PYRSB7080SDT	I-Force Eyewear Anti-Fog In/Outdoor Lens	EA	\$18.33



PYRSB7020SDT

### A. Cloak™ Dual Mold Goggles

The polycarbonate lens provides impact resistance while the built-in ventilation channel provides extra fog control. Made of dual injected rubber that provides a soft, comfortable seal. Features a clip attachment for easy lens replacement and a neoprene head strap. Meets or exceeds ANSI Z87.1+ standards.

SKU	Description	Lens	UOM	Price
RADDMG11	Cloak goggle	Clear anti-fog	PR	\$10.86
RADDMG-21	Cloak goggle	Smoke anti-fog	PR	\$11.52
RADDMG-41	Cloak goggle	Amber anti-fog	PR	\$11.51
RADDMGRL-11	Replacement lens	Clear anti-fog	EA	\$4.08
RADDMGRL-21	Replacement lens	Smoke anti-fog	EA	\$4.32
RADDMGRL-41	Replacement lens	Amber anti-fog	EA	\$4.32



RADDMG11



RADBG1-20

### B. Barricade™

These lightweight stylish goggles have an adjustable elastic strap that provides a comfortable, easy adjustable fit. The indirect venting system provides extra fog control and ventilation while the polycarbonate lens provide impact resistance. The soft rubber frame offers maximum all-day comfort. Meets or exceeds ANSI Z87.1 + standards.

SKU	Description	Lens	UOM	Price
RADBG1-10	Barricade™	Clear	PR	\$3.03
RADBG1-11	Barricade™	Clear A/F	PR	\$3.52
RADBG1-20	Barricade™	Smoke	PR	\$3.23
RADBG1-21	Barricade™	Smoke A/F	PR	\$3.75
RADBG1-91	Barricade™	Indoor/Outdoor A/F	PR	\$4.37

### C. Chemical Goggles

Goggle equipped with indirect vent allows protection against chemical splashes. Designed with an adjustable headband and fits over most prescription eyewear. The clear optical grade polycarbonate lens provides 99.9% UVA and UVB protection. Scratch-resistant hard coat protects lens and maintains optical clarity. Meets ANSI Z87.1-2003 eyewear requirements as high impact protectors. Evaluated to Canadian safety requirements.

SKU	Description	UOM	Price	
RADGG0111ID	Goggles	Clear anti-fog	PR	\$2.13
RADGG011UID	Goggles	Clear uncoated	PR	\$1.42



RADGG0111ID



RADGGP111ID

### D. Perforated Goggles

The perforated goggle provides excellent ventilation and protects against dust and flying debris. It is designed with an adjustable elastic headband and fits over most prescription eyewear. The clear optical grade polycarbonate lens provides 99.9% UVA and UVB protection. Scratch-resistant hard coat protects lens and maintains optical clarity. Meets ANSI Z87.1-2003 eyewear requirements as high impact protectors. Evaluated to Canadian safety requirements.

SKU	Description	Lens	UOM	Price
RADGGP111ID	Perforated	Clear anti-fog	PR	\$2.15





by Honeywell

### A. Uvex Stealth™



S3960C

The Uvex Stealth™ has a unique lens system that allows for quick and simple replacement. Uvex Stealth's combination of lightweight comfort, low profile, and futuristic good looks affords superior protection and meets industry standards. The remarkable indirect ventilation system channels and directs air flow over the lens. The quick-adjust headband clips permit fast and easy fitting even on hardhats. Once adjusted the textured headband grip will not slip. Toric lens provide superior optics and peripheral vision. Rx insert available. Meets ANSI Z87+ and CSA Z94.3 standards.

SKU	Description	Lens	UOM	Price
S3960C	Uvex Stealth Gray Body	Clear Uvextreme Anti-fog	EA	\$11.66
S3960HS	Uvex Stealth Gray Body	Clear HydroShield Anti-Fog	EA	\$17.67
S3961C	Uvex Stealth Gray Body	Gray Uvextreme Anti-fog	EA	\$12.49
S3961HS	Uvex Stealth Gray Body	Gray HydroShield Anti-Fog	EA	\$18.64
S700C	Clear replacement lens	Clear Uvextreme Anti-fog	EA	\$4.49
S700HS	Clear replacement lens	Clear HydroShield Anti-Fog	EA	\$6.96
S701C	Gray replacement lens	Gray Uvextreme Anti-fog	EA	\$5.32
S701HS	Gray replacement lens	Gray HydroShield Anti-Fog	EA	\$8.09

### B. Uvex Stealth™ OTG

The highest levels of comfort, protection, performance and sleek styling now combine with an over-the-glass prescription eyewear option. The Uvex Stealth family, one of the most popular goggles on the market, has expanded to include an OTG style. These goggles offer modern design, technology and materials coupled with premier performance, comfort and adjustability features. Ideal for impact, dust and airborne particles, chemical splash, and optical radiation (UV and welding/heat radiation), the new expanded Uvex Stealth family continues to make it easy to wear goggles on the job, no matter what the application. High impact protection certified to ANSI Z87.1-2003 (High Impact) and CSA Z94.3.

SKU	Description	Lens	UOM	Price
S3970D	Stealth goggle OTG, neoprene strap	Clear Dura-Streme Anti-Fog/Anti-Scratch	EA	\$14.50
S3971D	Stealth goggle OTG, neoprene strap	Gray Dura-Streme Anti-Fog/Anti-Scratch	EA	\$15.54



S3971D



S3400X

### C. Uvex Flex Seal®

Lightweight, silicone body contours to the face for superior protection from impacts and chemical spills. Low profile and optically correct polycarbonate lens provides full field of vision. Fogging is minimized by the Uvextreme® anti-fog coating and indirect venting system. Fits over most prescription eyewear and has pivoting headband clips for a comfortable, snug fit. Meets ANSI Z87+ and CSA Z94.3 standards.

SKU	Description	Fame	Lens	UOM	Price
S3400X	Uvex Flex Seal	Navy	Clear Uvextreme Anti-fog	EA	\$12.14

### D. Uvex Strategy™ OTG

The Uvex Strategy goggle offers all-day comfort, exceptional fit and protection- even in extreme environments. It provides protection against impact, chemical splash, dust, sand, and debris. The Uvex Strategy goggle is the latest in OTG comfort and technology. All the comfort, quality and protection you expect from Uvex at a price you'll love. Meets ANSI Z87+ and CSA Z94.3.

SKU	Description	Vent	Lens	UOM	Price
S3800	Uvex Strategy, fabric strap	Direct	Clear Uvextreme Anti-fog	PR	\$7.09



S3800



by Honeywell

**A. Uvex Classic™**

Soft clear vinyl frame goggles have a wide flange to comfortably hug facial contours. Uvex-treme® anti-fog coating on clear lenses resists fogging, scratching, static and UV radiation. Simple lens replacement system. Four models available whether for dust, mist or chemical splash. Fits over most Rx spectacles. Meets ANSI Z87+ and CSA Z94.3 requirements.

SKU	Description	Frame	UOM	Price
S350	Uvex Classic	Hood indirect vent	EA	\$6.88
S350CF	Uvex Classic	Face foam (non-chemical splash apps.)	EA	\$11.53
S360	Uvex Classic	Indirect vent	EA	\$5.89
S364	Uvex Classic	Closed vent	EA	\$6.95



S360



**PYRAMEX**

**B**

**B. Pyramex Capstone Goggle and Ratching Shield**



PYRAG504DT

The Capstone G504DT features a dual lens that ensures ultimate anti-fog performance. Indirect-vent frame provides protection against splash and dust. Double lens consists of polycarbonate lens on the outer side with acetate anti-fog lens on inner side. Adjustable quick release elastic band for easy on/off and soft vinyl goggle body conforms to facial contours for a comfortable, custom fit. Fits over prescription eyewear. Exceeds the ANSI Z87.1 High Velocity Impact Standards. CSA Z94.3 Standards

The Capstone Ratching Shield includes strap and clips allowing the user to add to either of the Capstone 500 Series goggles. Meets ANSI Z87.1+ High Impact Requirements, CAN/CSA Z94.3-07 Standards.

SKU	Description	UOM	Price
PYRAG504DT	Capstone Gpgggle, Clear Dual Anti-Fog Lens	EA	\$11.79



**C. Odyssey®II Chemical Splash Goggle**

The Sellstrom® Odyssey®II chemical splash goggle has a sealed “dual” anti-fog lens with scratch-resistant on the outside and anti-fog on the inside. Other features include UV absorbing polycarbonate, ultra comfortable, soft goggle body for a snug seal, and indirect vents on the top and bottom, protecting against liquids and dust while permitting indirect ventilation. It has extra wide peripheral vision, easy strap adjustment and fits over prescription eyewear. Meets ANSI Z87.1-2003 standards and CAN/CSA-Z94.3 standards.

SKU	Description	Lens	UOM	Price
SEL80201	Odyssey II goggle with neoprene strap	Clear	EA	\$11.95
SEL80203	Odyssey II goggle with neoprene strap	Smoke	EA	\$11.95
SEL80242	Replacement lens Odyssey II	Clear	EA	\$7.21
SEL80249	Replacement lens Odyssey II	Smoke	EA	\$7.21



SEL80201



# Compliant Protection is our Speciality

## New! Soft Polymer FDA Medical-Grade B-22 MHS Sidewear

- Certified Compliant by 3rd party independent testing to ANSI Z87.1
- SafetyWing™ auto adjust to individual facial features



Applications :

- Medical/Surgical
- Light Industrial
- Personal

**B22 MHS**  
Multi Hazard Shield



**BEFORE**



**GREENER**



**BEFORE**



**GREENER**

SKU	Description	UOM	Price
SAFOB22-C	B22 sideshields, clear	10/BX	\$27.50
SAFOB22-BL	B22 sideshields, black	10/BX	\$27.50

SKU	Description	UOM	Price
SAFOB22-B	B22 sideshields, glacier blue	10/BX	\$27.50
SAFOB22-A	B22 sideshields, amber	10/BX	\$27.50

## High Impact Polycarbonate • High Velocity Impact B-52+® B-26+® B-53+™ B-27+™ Sidewear®

- Certified compliant by 3rd party independent testing to ANSI Z-87.1.
- SafetyWing™ protects orbital area from lacerations and fractures.
- Engineered to easily adjust and attach to small medium and large frames
- Optional Comfort Cushions absorb shock
- Greatly reduce foreign body injuries.
- Molded from impact resistant Polycarbonate
- Affords UV protection up to 380 nanometers.



The patented SafetyWing™ distributes impact evenly over the entire wing surface and surrounds the exposed eye orbit area to maximize protective coverage.



A B-26 Side Shield successfully deflecting a 1/4" steel ball at 150 fps (102mph) during testing.



'Aye Mate' B-52+® Pack  
Item# B-52+ Plus



'Wing Mate' for SM & MED Safety Frames  
Compliance Safepack® Plus™  
Item# CP-5226



'Wing Mate' B-26+® Plus™ Pack  
Item# B-26+ Plus



For SM & MED Safety Frames  
Sunmate Combo Safepack®  
Item# SM-5327

### Save Time and Money!

Our SideWear® Shield design will fit over 300 safety frames of various shapes and sizes and can easily replace more than 150 OEM side shields!

SKU	Description	UOM	Price
SAFOCP52/26	Compliance Safepack™ Plus (10 of B52+, 10 of 26+)	20/BX	\$53.33
SAFOSM5327	Sunmate® Combo pack (10 of B53+, 10 of 27+)	20/BX	\$53.33
SAFOB26	B26+ sideshields	20/BX	\$53.33
SAFOB52+	B52+ sideshields	20/BX	\$53.33



**A. BANDIT™ Goggle Retainer**

The BANDIT™ Goggle Retainer is designed for use where protective goggles must be worn with a safety cap or hat. Installs quickly and easily. No tools required. Dielectric retainer will retain the goggle on the safety cap when the goggle is not in use; and hold the goggles securely when worn for eye protection. (Goggles, cap, or hat not included).

SKU	Description	Style	UOM	Price
CHE9652	Goggle retaining ring	Cap	EA	\$10.93
CHE9662	Goggle retaining ring	Hat	EA	\$12.40

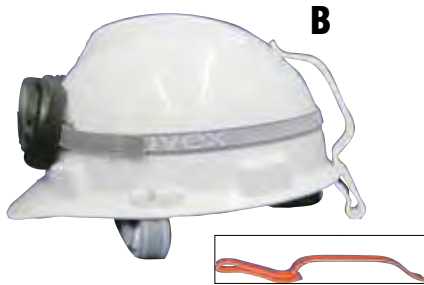

**B. Goggle Clip**

Secures to the back of a hard cap to hold goggles in place when not in use.

SKU	Description	UOM	Price
FRAKYM=KYOH	Goggle clip for full brim hard hat	EA	\$6.79
FRAKYM=KYWC	Goggle clip for cap hard hat	EA	\$6.79

**C. Adhesive Goggle Clip**

Goggle clips hold safety goggles securely on your hard hat between tasks. Two clips supplied on a rubber-based, closed cell foam adhesive per package. The flexible tangs allow for easy removal and replacement of goggle strap.

SKU	Description	UOM	Price
CATFANY8129D	Goggle clip adhesive for hard hat	PR	\$4.25



**D. Goggle Buddy**

Goggle buddy protects your goggles when not in use to extend their life.

SKU	Description	UOM	Price
MSSGB	Goggle Buddy	EA	\$5.88

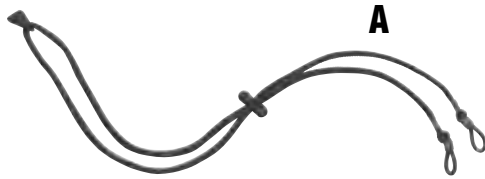

### A. Uvex Universal Eyeglass Retainer

Uvex snap-fit cords feature a unique break-away system! Universal cords fit all Uvex spectacles.

SKU	Description	UOM	Price
S501	Uvex universal eyeglass cord	EA	\$2.25



### B. Chums Original® Cotton - Standard End Retainer

Improve compliance & reduce costs from safety glass damage and loss with Chums original eyewear retainer. The world's first all cotton, fully adjustable eyewear retainer was designed to fit a variety of the most common frame sizes and styles. Proudly Made in the USA.

SKU	Description	Color	UOM	Price
CHUM101	Chums Original	Black	EA	\$2.37
CHUMS101	Chums Original	Royal blue	EA	\$2.37
CHUMS102	Chums Original	Red	EA	\$2.37
CHUMS105	Chums Original	Navy	EA	\$2.37
CHUMS108	Chums Original	Yellow	EA	\$2.37



CHUM101

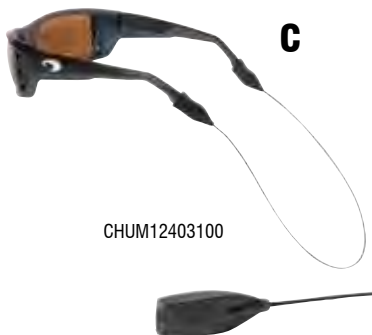

CHUM12403100

### C. Chums Orbiter Eyewear Retainer

An Eyewear Retainer with an edge, the Chums Orbiter molds form with function. Ultra light and super sleek the Orbiter's halo effect keeps it out of your way. The Orbiter has low profile flat temples that eliminate pressure points and fit all eyeglass styles. Weighing in at less than a gram the Orbiter is comfort defined. Features ultra light stainless cable, low profile flat temples eliminate pressure points, universal temple design fits large and small frames and comes in 2 colors: black & clear. Made in USA by Chums.

SKU	Description	Color	UOM	Price
CHUM12403100	Chums Orbiter eyewear retainer	Black	EA	\$3.95

### D. See-It Safe® ID Holder

The See-It Safe® is a clear case for holding ID badges, drivers license, credit cards etc. It is translucent in color and comes with a nylon lanyard with breakaway clip (or carabiner). Compact size 2.5" wide x 3.7" high x .75" deep.

SKU	Description	UOM	Price
WITZ004-11	Badge holder with lanyard clear	EA	\$6.05



### A. Plastic Lens Cleaning Station

Disposable station contains 8 oz. of anti-fog, anti-static lens cleaning solution and 760 tissues. Made of rugged plastic and mounts on wall for added convenience.

SKU	Description	UOM	Price
MSS101P	Plastic lens cleaning station	EA	\$6.46



A



B

### B. Pre-Moistened Lens Cleaning Towelettes

Towelette Dispenser comes completely assembled and ready for use. Towelettes are pre-moistened with anti-fog, anti-static formula for use on plastic, polycarbonate and glass lenses. Manufactured with sturdy corrugated cardboard featuring pull out bottom for easy dispensing and built in tab for hanging. Dispenser holds 100 - 5"x 8" individually packaged lens cleaning towelettes.

SKU	Description	UOM	Price
MSSLCT	Pre-moistened lens cleaning towelettes	EA	\$4.97

### C. Lens Cleaning Tissue

Low lint non-abrasive tissues leave lenses clear and streak free. Highly absorbent tissue allows for quick and economical cleaning.

SKU	Description	UOM	Price
MSS90	Lens cleaning tissues	300/BX	\$1.50



C



D

### D. Magic Fog-Be-Gone Lens Cleaning Station

Magic Fog-Be-Gone Lens Cleaning Station contains (1200) interfold 5" X 8" tissues and one 16 oz bottle of fluid. The Fog-Be-Gone fluid is use for extreme anti-fog needs. Safe for all types of glass, plastic or polycarbonate eyeglasses, safety glasses, goggles, and face shields.

SKU	Description	UOM	Price
MSS84	Lens cleaning station 16 oz & 1,200 tissues	EA	\$10.08





### A. Fog Shield XP™ Wipes

The exclusive FogShield XP™ Pre-Moistened Lens Cleaning Tissues provide anti-fog protection for harsh working environments. The two-step process offers effective cleaning and extreme anti-fog protection. Created for use in extreme temperature environments and works for both glass and plastic lenses.

SKU	Description	UOM	Price
BL8577PMT	Fog Shield XP™ Wipes	25/BX	\$8.09

### B. Fog Shield XP™ Cleaning Station

The Fog Shield XP™ Lens Cleaning Station combines effective cleaning and anti-fog protection. The extra heavy-duty corrugate construction is specially designed to withstand industrial conditions. The compact size and high tissue count make it perfect for high traffic areas and low maintenance programs. Front access allows for easy hanging in tight corners and dispensing from countertops with minimal space required. Contains anti-fog cleaning solution with silicone and tissues (1520 qty) (4-3/4" x 6-1/2"). Station dimensions 7-1/2" x 10" x 5-1/4".

SKU	Description	UOM	Price
BL8577	Fog Shield XP™ cleaning station	EA	\$21.89
BL77	Fog Shield XP™ Solution, 12 oz	EA	\$5.67



### C. Sight Savers® Lens Cleaning Fluid with Silicone

This economical anti-fog, anti-static lens cleaning spray fights stubborn dirt and grease residue as it cleans, polishes and protects eyewear. 16 oz. oval bottle, with silicone (includes pump).

SKU	Description	UOM	Price
BL68	Lens cleaning fluid with silicone 16 oz	EA	\$4.16

### D. Sight Savers® Pre-Moistened Lens Cleaning Tissues

Sight Savers® Pre-Moistened Lens Cleaning Tissues are individually packaged tissues treated with special surfactants that clean all glass and plastic lenses. The tissues provide anti-static and anti-fog protection for moderate conditions. They are convenient to use; perfect for home, light industrial, office, toolbox, glove compartment, car or truck. Excellent for safety and prescription eyeglasses\*, goggles, face shields, computer screens, automobile mirrors and more.

\*While our products are safe, it should be noted that some coatings are fragile and will wear off over time, regardless of the cleaning regimen used.

SKU	Description	UOM	Price
BL8574GM	Pre-moistened lens Tissue 100	BX	\$12.35



### E. Sight Savers® All Purpose Tissues

All Purpose Tissues are soft, absorbent, low lint tissues for all-purpose usage. Come in boxes of 280 tissues (5 x 8).

SKU	Description	UOM	Price
BL8566	All purpose tissue 280/bx	BX	\$2.01



# Head/Face Protection





**A**



Flex-Gear™ Suspension



Lockpin Suspension

### A. Standard Series S61 Hard Caps

The S61 is the latest in the “Standard Series” hard hat line from Bullard. It sports a low-profile shell design and upgraded features and benefits. With its 4-point suspension system, users can choose from a pinlock or upgraded “Flex-Gear®” ratchet suspension with absorbent, cotton brow pad. The S61 is ideal for the construction and everyday work environments. Meets ANSI Z89.1-2009, Type I, Class E and G standards.

SKU	Description	Suspension	Color	UOM	Price
BULS61BK	Low Profile cap	Pin	Black	EA	\$7.89
BULS61CB	Low Profile cap	Pin	Brown	EA	\$7.89
BULS61DG	Low Profile cap	Pin	Dove gray	EA	\$7.89
BULS61FG	Low Profile cap	Pin	Forest green	EA	\$7.89
BULS61GG	Low Profile cap	Pin	Gull gray	EA	\$7.89
BULS61HO	Low Profile cap	Pin	Hi-viz orange	EA	\$7.89
BULS61HY	Low Profile cap	Pin	Hi-viz yellow	EA	\$7.89
BULS61KB	Low Profile cap	Pin	Kentucky blue	EA	\$7.89
BULS61KG	Low Profile cap	Pin	Kelly green	EA	\$7.89
BULS61LP	Low Profile cap	Pin	Light pink	EA	\$7.89
BULS61NB	Low Profile cap	Pin	Navy blue	EA	\$7.89
BULS61OR	Low Profile cap	Pin	Orange	EA	\$7.89
BULS61PB	Low Profile cap	Pin	Pacific blue	EA	\$7.89
BULS61RD	Low Profile cap	Pin	Red	EA	\$7.89
BULS61SK	Low Profile cap	Pin	Sky blue	EA	\$7.89
BULS61SL	Low Profile cap	Pin	Slate blue	EA	\$7.89
BULS61TN	Low Profile cap	Pin	Tan	EA	\$7.89
BULS61WH	Low Profile cap	Pin	White	EA	\$7.89
BULS61YL	Low Profile cap	Pin	Yellow	EA	\$7.89
BULS61RKG	Low Profile cap	Flex-Gear	Black	EA	\$12.22
BULS61RCB	Low Profile cap	Flex-Gear	Brown	EA	\$12.22
BULS61RDG	Low Profile cap	Flex-Gear	Dove gray	EA	\$12.22
BULS61RFG	Low Profile cap	Flex-Gear	Forest green	EA	\$12.22
BULS61RGG	Low Profile cap	Flex-Gear	Gull gray	EA	\$12.22
BULS61RHO	Low Profile cap	Flex-Gear	Hi-viz orange	EA	\$12.22
BULS61RHY	Low Profile cap	Flex-Gear	Hi-viz yellow	EA	\$12.22
BULS61RKB	Low Profile cap	Flex-Gear	Kentucky blue	EA	\$12.22
BULS61RKG	Low Profile cap	Flex-Gear	Kelly green	EA	\$12.22
BULS61RLP	Low Profile cap	Flex-Gear	Light pink	EA	\$12.22
BULS61RNB	Low Profile cap	Flex-Gear	Navy blue	EA	\$12.22
BULS61ROR	Low Profile cap	Flex-Gear	Orange	EA	\$12.22
BULS61RPB	Low Profile cap	Flex-Gear	Pacific blue	EA	\$12.22
BULS61RRD	Low Profile cap	Flex-Gear	Red	EA	\$12.22
BULS61RSK	Low Profile cap	Flex-Gear	Sky blue	EA	\$12.22
BULS61RSL	Low Profile cap	Flex-Gear	Slate blue	EA	\$12.22
BULS61RTN	Low Profile cap	Flex-Gear	Tan	EA	\$12.22
BULS61RWH	Low Profile cap	Flex-Gear	White	EA	\$12.22
BULS61RYL	Low Profile cap	Flex-Gear	Yellow	EA	\$12.22

### B. Low Profile S62 Vented Cap

The S62 is the NEW Bullard “Standard Series” vented hard hat. It sports a low-profile, vented shell design and upgraded features and benefits. With its 4-point suspension system, users can choose from a pinlock or upgraded “Flex-Gear®” ratchet suspension with absorbent, cotton brow pad. The S62 is ideal for the construction and everyday work environments.

SKU	Description	Suspension	Color	UOM	Price
BULS62WHR	Cap Vented	Flex-Gear	White	EA	\$12.90
BULS62YLR	Cap Vented	Flex-Gear	Yellow	EA	\$12.90
BULS62RDR	Cap Vented	Flex-Gear	Red	EA	\$12.90
BULS62KBR	Cap Vented	Flex-Gear	Kentucky Blue	EA	\$12.90

**B**





## A. Standard Series S71 Full Brim Hard Hats

The Bullard Model S71 is a full brim hat offered with the option of a standard or ratchet suspension which features a replaceable cotton brow pad. The suspension system has four points of attachment with four separate keys for a secure fit and 3/4" wide crown straps for comfort. Meets ANSI Z89.1-2009, Type I, Class E and G standards.

SKU	Description	Suspension	Color	UOM	Price
BULS71BK	Low Profile hat	Pin	Black	EA	\$10.22
BULS71CB	Low Profile hat	Pin	Brown	EA	\$10.22
BULS71DG	Low Profile hat	Pin	Dove gray	EA	\$10.22
BULS71FG	Low Profile hat	Pin	Forest green	EA	\$10.22
BULS71GG	Low Profile hat	Pin	Gull gray	EA	\$10.22
BULS71HO	Low Profile hat	Pin	Hi-viz orange	EA	\$10.22
BULS71HY	Low Profile hat	Pin	Hi-viz yellow	EA	\$10.22
BULS71KB	Low Profile hat	Pin	Kentucky blue	EA	\$10.22
BULS71KG	Low Profile hat	Pin	Kelly green	EA	\$10.22
BULS71LP	Low Profile hat	Pin	Light pink	EA	\$10.22
BULS71NB	Low Profile hat	Pin	Navy	EA	\$10.22
BULS71OR	Low Profile hat	Pin	Orange	EA	\$10.22
BULS71PB	Low Profile hat	Pin	Pacific blue	EA	\$10.22
BULS71RD	Low Profile hat	Pin	Red	EA	\$10.22
BULS71SK	Low Profile hat	Pin	Sky blue	EA	\$10.22
BULS71SL	Low Profile hat	Pin	Slate blue	EA	\$10.22
BULS71TN	Low Profile hat	Pin	Tan	EA	\$10.22
BULS71WH	Low Profile hat	Pin	White	EA	\$10.22
BULS71YL	Low Profile hat	Pin	Yellow	EA	\$10.22
BULS71RBK	Low Profile hat	Flex-Gear	Black	EA	\$15.46
BULS71RCB	Low Profile hat	Flex-Gear	Brown	EA	\$14.54
BULS71RDG	Low Profile hat	Flex-Gear	Dove gray	EA	\$14.54
BULS71RFG	Low Profile hat	Flex-Gear	Forest Green	EA	\$14.54
BULS71RGG	Low Profile hat	Flex-Gear	Gull gray	EA	\$14.54
BULS71RHO	Low Profile hat	Flex-Gear	Hi-viz orange	EA	\$14.54
BULS71RHY	Low Profile hat	Flex-Gear	Hi-viz yellow	EA	\$14.54
BULS71RKB	Low Profile hat	Flex-Gear	Kentucky blue	EA	\$14.54
BULS71RKG	Low Profile hat	Flex-Gear	Kelly green	EA	\$14.54
BULS71RLP	Low Profile hat	Flex-Gear	Light pink	EA	\$14.54
BULS71RNB	Low Profile hat	Flex-Gear	Navy blue	EA	\$14.54
BULS71ROR	Low Profile hat	Flex-Gear	Orange	EA	\$14.54
BULS71RPB	Low Profile hat	Flex-Gear	Pacific blue	EA	\$14.54
BULS71RRD	Low Profile hat	Flex-Gear	Red	EA	\$14.54
BULS71RSK	Low Profile hat	Flex-Gear	Sky blue	EA	\$14.54
BULS71RSL	Low Profile hat	Flex-Gear	Slate blue	EA	\$14.54
BULS71RTN	Low Profile hat	Flex-Gear	Tan	EA	\$14.54
BULS71RWH	Low Profile hat	Flex-Gear	White	EA	\$14.54
BULS71RYL	Low Profile hat	Flex-Gear	Yellow	EA	\$14.54



Colors may vary slightly from what is shown.



### WEB INFORMATION

For a full listing and online ordering visit our website at: [www.gosafe.com](http://www.gosafe.com)



**A**

### A. V-Gard® Full Brim Hard Hats

The V-Gard Protective Hard Hat utilizes a full brim to provide optimum coverage and protection. These MSA hard hats come with the Staz-On® and Fas-Trac® suspension. Complies with ANSI/ISEA Z89.1-2009 (Class E) standards for a Type I (top impact) helmet.

SKU	Description	Suspension	Color	UOM	Price
MSA454730	Full brim	Staz-On	Yellow	EA	\$12.44
MSA454731	Full brim	Staz-On	Gray	EA	\$12.44
MSA454732	Full brim	Staz-On	Blue	EA	\$12.44
MSA454733	Full brim	Staz-On	White	EA	\$12.44
MSA454734	Full brim	Staz-On	Orange	EA	\$12.44
MSA454735	Full brim	Staz-On	Green	EA	\$12.44
MSA454736	Full brim	Staz-On	Red	EA	\$12.44
MSA489360	Full brim	Staz-On	Hi-Viz Orange	EA	\$12.44
MSA815562	Full brim	Staz-On	Hi-Viz Green	EA	\$12.44
MSA475366	Full brim	Fas-Trac	Yellow	EA	\$18.53
MSA475367	Full brim	Fas-Trac	Gray	EA	\$18.53
MSA475368	Full brim	Fas-Trac	Blue	EA	\$18.53
MSA475369	Full brim	Fas-Trac	White	EA	\$18.53
MSA475370	Full brim	Fas-Trac	Green	EA	\$18.53
MSA475371	Full brim	Fas-Trac	Red	EA	\$18.53
MSA814053	Full brim	Fas-Trac	Gold	EA	\$18.53
MSA10021292	Full brim	Fas-Trac	Hi-Viz Orange	EA	\$18.53
MSA815570	Full brim	Fas-Trac	Hi-Viz Green	EA	\$18.53
MSA454230	Replacement suspension	Staz-On		EA	\$7.54
MSA473332	Replacement suspension	Fas-Trac		EA	\$12.21

### B. V-Gard® Standard Hard Caps

These MSA hard hats are the number one hard hat for most industrial applications. The shell is made with a durable injection-molded, high-density polyethylene. These MSA hard hats are available with the Fas-Trac® or Staz-On® suspension for superior head protection. In addition, this MSA cap is designed with an accessories slot to accommodate many add-on features and also includes a Cushionaire™ sweatband and adjustable crown straps. Complies with ANSI/ISEA Z89.1-2009 (Class E) standards for a Type I (top impact) helmet.

SKU	Description	Suspension	Color	UOM	Price
MSA477477	Small V-Gard	Fas-Trac	White	EA	\$18.53
MSA463942	Standard V-Gard	Staz-On	White	EA	\$8.36
MSA463111	Standard V-Gard	Staz-On	Robin's egg blue	EA	\$8.36
MSA463943	Standard V-Gard	Staz-On	Blue	EA	\$8.36
MSA463944	Standard V-Gard	Staz-On	Yellow	EA	\$8.36
MSA463945	Standard V-Gard	Staz-On	Orange	EA	\$8.36
MSA463946	Standard V-Gard	Staz-On	Green	EA	\$8.36
MSA463947	Standard V-Gard	Staz-On	Red	EA	\$8.36
MSA463948	Standard V-Gard	Staz-On	Gray	EA	\$8.36
MSA464658	Standard V-Gard	Staz-On	Brown	EA	\$8.36
MSA464852	Standard V-Gard	Staz-On	Gold	EA	\$8.36
MSA475235	Standard V-Gard	Staz-On	Black	EA	\$8.36
MSA478237	Standard V-Gard	Staz-On	Light buff	EA	\$8.36
MSA488398	Standard V-Gard	Staz-On	Purple	EA	\$8.36
MSA488148	Standard V-Gard	Staz-On	Hi-Viz Orange	EA	\$8.36
MSA815558	Standard V-Gard	Staz-On	Hi-Viz Green	EA	\$8.36
MSA475358	Standard V-Gard	Fas-Trac	White	EA	\$13.88
MSA495853	Standard V-Gard	Fas-Trac	Robin's egg blue	EA	\$13.88
MSA475359	Standard V-Gard	Fas-Trac	Blue	EA	\$13.88
MSA475360	Standard V-Gard	Fas-Trac	Yellow	EA	\$13.88
MSA475361	Standard V-Gard	Fas-Trac	Orange	EA	\$13.88
MSA475362	Standard V-Gard	Fas-Trac	Green	EA	\$13.88
MSA475363	Standard V-Gard	Fas-Trac	Red	EA	\$13.88
MSA475364	Standard V-Gard	Fas-Trac	Gray	EA	\$13.88
MSA495854	Standard V-Gard	Fas-Trac	Brown	EA	\$13.88
MSA475365	Standard V-Gard	Fas-Trac	Gold	EA	\$13.88
MSA492559	Standard V-Gard	Fas-Trac	Black	EA	\$13.88
MSA488146	Standard V-Gard	Fas-Trac	Hi-Viz Orange	EA	\$13.88
MSA473284	Large V-Gard	Staz-On	White	EA	\$12.44
MSA477482	Large V-Gard	Fas-Trac	White	EA	\$18.53
MSA477483	Large V-Gard	Fas-Trac	Blue	EA	\$18.53
MSA488525	Adapter for welding helmet and shield replacement suspension			EA	\$15.81
MSA492568	Replacement suspension, large	Fas-Trac		EA	\$12.72
MSA454230	Replacement suspension	Staz-On		EA	\$7.54
MSA473332	Replacement suspension	Fas-Trac		EA	\$12.21



**B**



Staz-On Suspension



Fas-Trac Suspension



### A. Freedom Series™ Caps

Hard hat wearers can express their patriotism and protect their heads by wearing one of MSA's new special series of Freedom caps. The bright designs are exceptionally attractive, with a superior shiny finish, on the V-Gard Cap shell. Meet all applicable requirements for a Type I (top impact) helmet as outlined in ANSI/ISEA Z89.1-2009 (Class E).

SKU	Description	Suspension	Style	UOM	Price
MSA10052947	Freedom Series Caps	Fas-Trac®	Flag w/eagles	EA	\$31.97
MSA10052945	Freedom Series Caps	Fas-Trac®	Stars and stripes	EA	\$31.97
MSA10050611	Freedom Series Caps	Fas-Trac®	Dual Flags	EA	\$31.97
MSA10034263	Freedom Series Caps	Fas-Trac®	United we stand	EA	\$14.17



A

### B. SKULLGARD® Protective Caps

Skullgard caps and hats feature heavy-duty construction for use in steel mills and other heavy industries where elevated temperatures are common. Available in Fas-Trac™ or Staz-On™ suspensions. Meet all applicable requirements for a Type I (top impact) helmet as outlined in ANSI/ISEA Z89.1-2009 (Class G). These caps and hats also meet the ANSI/ISEA Z89.1-2009 voluntary standard for low temperature.

SKU	Description	Suspension	Color	UOM	Price
MSA454617	Cap	Staz-On	Natural tan	EA	\$94.61
MSA454618	Cap	Staz-On	White	EA	\$99.67
MSA475395	Cap	Fas-Trac	Natural tan	EA	\$106.22
MSA475396	Cap	Fas-Trac	White	EA	\$111.28
MSA454664	Hat	Staz-On	Natural tan	EA	\$105.37
MSA475407	Hat	Fas-Trac	Natural tan	EA	\$116.59
MSA454231	Replacement suspensions	Staz-On		EA	\$10.03
MSA473334	Replacement suspensions	Fas-Trac		EA	\$16.21

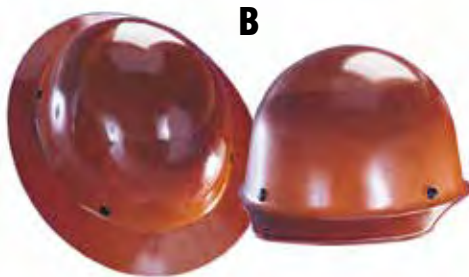

B

### C. Vented Advance® Cap with 6-Point Fas-Trac® Suspension

Advance Caps are MSA's latest combination of advanced features - cooling vents for improved air circulation, lightweight design for added comfort, lateral contours above the ear for easy integration of hearing protection, and Glaregard™ underbrim to reduce reflective glare. Advance Caps are not specifically designed to protect against lateral blows from the front, side or rear. These MSA hard hats come with the six-point, Fas-Trac®, ratchet suspension for superior head protection. Meet all applicable requirements for a Type I (top impact) helmet as outlined in ANSI/ISEA Z89.1-2009 (Class C). These caps and hats also meet the ANSI/ISEA Z89.1-2009 voluntary standard for low temperature.

SKU	Description	Suspension	Color	UOM	Price
MSA10034027	Advance vented caps	Fas-Trac	White	EA	\$17.72
MSA10034028	Advance vented caps	Fas-Trac	Blue	EA	\$17.72
MSA10034029	Advance vented caps	Fas-Trac	Yellow	EA	\$17.72
MSA10034031	Advance vented caps	Fas-Trac	Red	EA	\$17.72

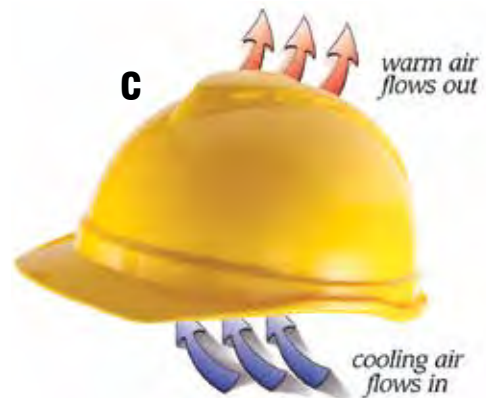

C





### A. Vanguard™ Cap

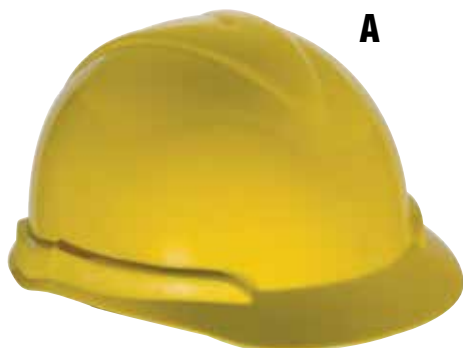

Vanguard (polyethylene) Helmets are designed to provide limited impact and penetration protection in the event of a top or lateral blow to the head, as well as limited protection against contact with high-voltage conductors. Representing the latest generation of protective headwear, they are tested to the same energy level for both top and lateral blows. Meet all applicable requirements for a Type I and II (top and lateral impact) helmet as outlined in ANSI/ISEA Z89.1-2009 (Class E).

SKU	Description	Suspension	Color	UOM	Price
MSA804939	Vanguard Helmet	Fas-Trac®	Yellow	EA	\$75.98
MSA804940	Vanguard Helmet	Fas-Trac®	White	EA	\$75.98
MSA804944	Vanguard Helmet	Fas-Trac®	Red	EA	\$75.98
MSA804946	Vanguard Helmet	Fas-Trac®	Blue	EA	\$75.98
MSA804947	Vanguard Helmet	Fas-Trac®	Hi-Viz Orange	EA	\$75.98

### B. Chinstrap

MSA Chinstraps can be worn to help keep hats and caps stable on the worker's head. They contain no metal parts, so they can be worn on dielectric headwear without affecting dielectric qualifications. Chinstraps attach directly to the MSA V-Gard shell. MSA chinstraps comply with ANSI Standard Z89.1-1997 for Industrial Head Protection. Elastic chinstrap with plastic hooks and buckle (attaches to the shell).

SKU	Description	UOM	Price
MSA88128	Chinstrap	EA	\$5.05

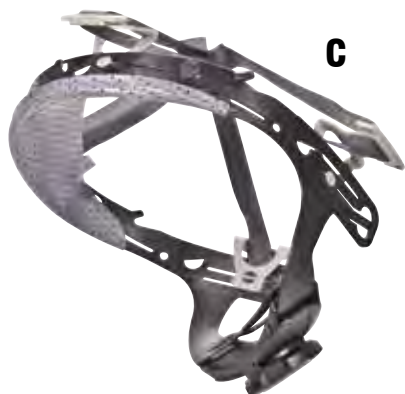

### C. MSA Fas-Trac® III Suspension

Ensuring your workforce wears their safety helmets can be a real headache. MSA, the leading provider of protective helmets, has the perfect remedy: the Fas-Trac® III Suspension. No more pressure headaches. No more pulled hair. No more falling off. No more sacrificing worker comfort for safety. Market-leading MSA helmets now have a comfort-leading suspension!

SKU	Description	UOM	Price
MSA10153384	Fas-Trac III Suspension 4-point standard-sized; for Thermalgard, Topgard®	EA	\$13.70

### D. Harley-Davidson® Hard Hat

High gloss, fully customized hard hat shell with realistic flame design and the legendary Harley-Davidson® Bar and Shield logo. Smooth ratchet adjustment is quick and easy to set, allowing for proper safety cap alignment. Breathable and washable cushioned sweatband provides increased comfort for the wearer. Type I Electric class G and E.

SKU	Description	UOM	Price
HDDHAT10	Harley-Davidson® black hat with red flames	EA	\$35.20

©2009 H-D, All Rights Reserved. Manufactured by Sperian under license from Harley-Davidson Motor Company.

WARNING: Not intended for use when riding a motorcycle. Improper use may result in serious personal injury or death.



## A. SUPEREIGHT® High Performance Hats and Caps

Fibre-Metal's technologically advanced thermoplastic safety hats and caps are the quality leader in head protection. They combine exceptional protective performance with extraordinary comfort to reduce risk and improve productivity. The unique, smooth crown design eliminates the risk of an impacting object being trapped by ribs, ridges or slots. All hats and caps include an 8-point suspension. Model E-1W full brim hat provides protection from the sun, non-toxic splash, dust, dirt and debris. Models E-1 and E-2 are SEI certified to meet ANSI Z89.1, Type 1, Class E, G or C.

SKU	Description	Suspension	Color	UOM	Price
FIBE2QRWGRY	Hard hat w/quick-lock	Ratchet	Grey	EA	\$20.39
FIBE2QRWVG	Hard hat w/quick-lock	Ratchet	Green	EA	\$20.39
FIBE2QRWR	Hard hat w/quick-lock	Ratchet	Red	EA	\$20.39
FIBE1RWW	Full brim hat	Ratchet	White	EA	\$19.18
FIBE1RWBE	Full brim hat	Ratchet	Blue	EA	\$19.18
FIBE1RWGY	Full brim hat	Ratchet	Grey	EA	\$19.18
FIBE1RWG	Full brim hat	Ratchet	Green	EA	\$19.18
FIBE1RWR	Full brim hat	Ratchet	Red	EA	\$19.18
FIBE2RWW	Hard cap	Ratchet	White	EA	\$16.76
FIBE2RWGRY	Hard cap	Ratchet	Grey	EA	\$16.76
FIBE2RWGR	Hard cap	Ratchet	Green	EA	\$16.76
FIBE2RWR	Hard cap	Ratchet	Red	EA	\$16.76
FIBE2RWY	Hard cap	Ratchet	Yellow	EA	\$16.76
FIBE2RWT	Hard cap	Ratchet	Tan	EA	\$16.76
FIBE2RWBLK	Hard cap	Ratchet	Black	EA	\$16.76
FIBE2RWGLD	Hard cap	Ratchet	Gold	EA	\$16.76
FIBE2RWSOA	Hard cap	Ratchet	Spirit of America	EA	\$37.59
FIB3RW	Replacement suspension ratchet w/holes			EA	\$12.22
FIB3RW-2	Replacement suspension ratchet w/tabs			EA	\$12.22
FIB3-S	Headband Swingstrap (reversible ratchet) attachment			EA	\$5.49
FIB3-SW	Replacement suspension w/revs. ratchet headband			EA	\$12.85
FIB3-SW2	Replacement suspension			EA	\$13.26



by Honeywell



FIBE2RWGR



FIB3RW-2



FIBP2RWG



FIBP2QRWR

## B. SUPEREIGHT® Heavy-Duty Fiberglass Caps

SUPEREIGHT® ROUGHNECK fiberglass protective caps set the standard for exceptional impact resistance, durability and crack resistance, all in the lightest weight fiberglass cap available. Comes with a unique Impact Energy Control System and extraordinary comfort features for long wearing comfort under tough working conditions. These fiberglass caps also come in an additional formulations for use when extreme hazards and working conditions require an extra margin of performance. Caps designated P-2H provide additional heat resistance. Select the industry's only 360° padded sweatband (model W-2F); the first and still the best strip-proof, crack-proof ratchet headband (model 3-RW2); or patented Swingstrap that combines the benefits of both with the added ability to convert from the front wearing position to the rear wearing position, (and back) without having to reverse the suspension or headband (3-SW2). Complies with ANSI Z89.1-1997, Type I, Class G Standards.

SKU	Description	Suspension	Color	UOM	Price
FIBP2QRWB	Hard hat w/quick-lock	Ratchet	Blue	EA	\$28.74
FIBP2QRWG	Hard hat w/quick-lock	Ratchet	Grey	EA	\$28.74
FIBP2QRWGR	Hard hat w/quick-lock	Ratchet	Green	EA	\$28.74
FIBP2QRWR	Hard hat w/quick-lock	Ratchet	Red	EA	\$28.74
FIBP2QRWW	Hard hat w/quick-lock	Ratchet	White	EA	\$28.74
FIBP2QSWBLUE	Hard hat w/quick-lock	Swingstrap	Blue	EA	\$31.41
FIBP2QSWGGRAY	Hard hat w/quick-lock	Swingstrap	Grey	EA	\$31.41
FIBP2QSWRED	Hard hat w/quick-lock	Swingstrap	Red	EA	\$31.41
FIBP2QSWW	Hard hat w/quick-lock	Swingstrap	White	EA	\$31.41
FIBP2RW/RED	Hard hat	Ratchet	Red	EA	\$25.11
FIBP2RWB	Hard hat	Ratchet	Blue	EA	\$25.11
FIBP2RWG	Hard hat	Ratchet	Grey	EA	\$25.11
FIBP2RWGR	Hard hat	Ratchet	Green	EA	\$25.11
FIBP2RWW	Hard hat	Ratchet	White	EA	\$25.11
FIBP2SWB	Hard hat	Swing ratchet	Blue	EA	\$27.66
FIBP2SWGR	Hard hat	Swing ratchet	Grey	EA	\$27.66
FIBP2SWR	Hard hat	Swing ratchet	Red	EA	\$27.66

### A. BrimGuard™



BrimGuard™ is the latest development in PPE providing color coding for work group identification for full brim hard hats. The patented seal ensures a secure fit. BrimGuard™ is stretched over and fits snugly around the brim without adhesives or glue.

SKU	Description	Color	UOM	Price
BRMBGR111	BrimGuard Night Work Reflective	Silver	EA	\$19.95
BRMBGR211	BrimGuard Night Work Reflective	Safety Yellow/Silver	EA	\$19.95
BRMBGR311	BrimGuard Night Work Reflective	Safety Orange/Silver	EA	\$19.95
BRMBGR411	BrimGuard Night Work Reflective	Safety Red/Silver	EA	\$19.95
BRMBGR511	BrimGuard Night Work Reflective	Safety Green/Silver	EA	\$19.95
BRMBGR611	BrimGuard Night Work Reflective	Safety Blue/Silver	EA	\$19.95
BRMBGR711	BrimGuard Night Work Reflective	Black/Silver	EA	\$19.95
BRMBGD110	BrimGuard Day Work	Silver	EA	\$12.95
BRMBGD210	BrimGuard Day Work	Safety Yellow	EA	\$12.95
BRMBGD310	BrimGuard Day Work	Safety Orange	EA	\$12.95
BRMBGD410	BrimGuard Day Work	Safety Red	EA	\$12.95
BRMBGD510	BrimGuard Day Work	Safety Green	EA	\$12.95
BRMBGD610	BrimGuard Day Work	Safety Blue	EA	\$12.95
BRMBGD710	BrimGuard Day Work	Black	EA	\$12.95



### B. Bullard Faceshield Brackets

The Bullard Gold Line® brackets are constructed from rugged, gold anodized aluminum. They are highly resistant to corrosion and heat and are ideal for chemical handling and high-heat industrial applications. Dielectric brackets are formed from lightweight, durable nylon and are ideal for general duty applications.

SKU	Description	Type	UOM	Price
BUL300B	Dielectric Faceshield Bracket	Cap	EA	\$10.95
BUL300BW	Dielectric Faceshield Bracket w/ Neoprene Gasket	Cap	EA	\$15.65
BUL312B	Dielectric Faceshield Bracket	Hat	EA	\$16.68
BUL100G	Aluminum bracket for S61	Cap	EA	\$11.12
BUL112G	Aluminum bracket for S71	Hat	EA	\$11.93

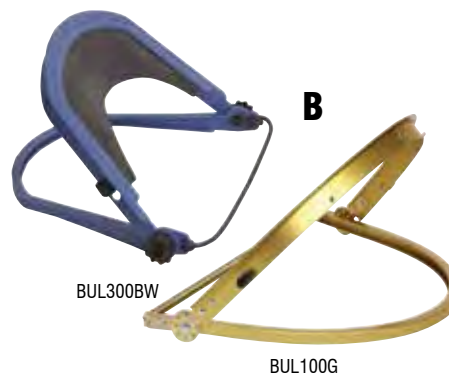

### C. Bullard Replacement Visors

Bullard visors conform to ANSI Z87.1-2003 standard for eye and face protection when used in combination with Bullard headgear or faceshield brackets. Visors are available in heat-formed acetate and wire mesh screens.

SKU	Description	Size	UOM	Price
BUL1040	Clear acetate visor	10" x 15" x 0.040"	EA	\$5.59
BUL8S24	Mesh black screen visor	8" x 15" x 24 mesh	EA	\$18.94
BUL840M	Clear Acetate	8" x 15" x .040"	EA	\$5.02
BUL840P	Clear heat-formed polycarbonate	8" x 15" x .040"	EA	\$5.95
BUL840ME	Clear flat polyester	8" x 15" x .040"	EA	\$2.34
BUL840MG	Dark green flat acetate	8" x 15" x 0.40"	EA	\$5.14

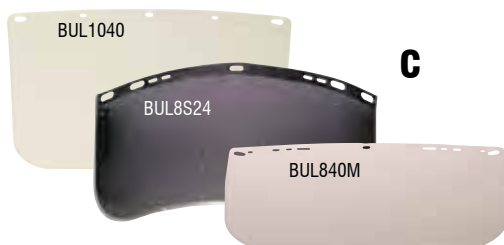

### D. Face Shield Brackets and Visors

Quality aluminum faceshield bracket and ratchet headgear and a visor selection. Aluminum bracket is dielectric. Visors sold separately.

SKU	Description	UOM	Price
MSS27908	Aluminum Bracket Cap Adapter	EA	\$8.21
ALL27910	Headgear ratchet style black	EA	\$10.10
MSS22644	Polycarbonate clear visor 8" X 15-1/2" X 0.040 meets ANSI Z87+	EA	\$4.87
MSS22667	Dark green visor 8" X 15-1/2" X 0.040 meets ANSI Z87+	EA	\$8.57
MSS22699	Clear visor 8" X 15-1/2" X 0.040 meets basic impact standard only	EA	\$1.19







by Honeywell



### A. Fibre-Metal Faceshield Brackets

Model F-300 is for light duty, general purpose face protection. Exceptionally lightweight and comfortable. Fits easily over today's spectacles with space for air circulation to prevent fogging. Accommodates a 4118 standard size (11-1/2" x 8") window. Model F-400 has a deep crown protector and wider windows for extended face protection. Deeper 4" crown protector extends protection without increasing weight. Incorporates wide-vision (17" x 8") wraparound windows and screens which provide 40% more protective area than standard size faceshields. Fits easily over required spectacles or respirators. Available with choice of three protective cap mounting mechanisms. High Performance protective faceshields can be equipped with model 5000 Speedy-Loop for easy on/off mounting on protective caps. Patented, adjustable loop fits Fibre-Metal caps and most competitive brands; model 4000 Quick-Lok cups for mounting on Fibre-Metal Caps equipped with Quick-Lok blocks for more permanent mounting.

SKU	Description	UOM	Price
FIBF300	Ratchet w/3" crown	EA	\$15.31
FIBF400	Bracket w/ratchet headgear	EA	\$18.78
FIBF500	Headgear, 7" crown	EA	\$22.60
FIBF4400	Bracket w/quick-loc	EA	\$10.92
FIBF4500	Bracket w/quick-loc caps	EA	\$18.91
FIBF5400	Bracket w/speedy loop	EA	\$16.69
FIBF5500	Bracket w/speedy loops mounts	EA	\$20.09

### Fibre-Metal Replacement Visors

SKU	Description	UOM	Price
FIB4118	Clear replacement visors 8" X 11.25" fits FIBF300 series	EA	\$4.93
FIB4118DRK	Green replacement visors 8" X 11.25" fits FIBF300 series	EA	\$5.27
FIB4178	Clear replacement visors 8" x 16.5"x .060 fits FIBF400 and FIBF500 series	EA	\$5.71
FIB4178DGR	Green replacement visors 8" x 16.5"x .060 fits FIBF400 and FIBF500 series	EA	\$5.95
FIB4178IR/UV	Shade 5 replacement visors 8" x 16.5"x .060 fits FIBF400 and FIBF500 series	EA	\$16.66
FIB4199CLR	Clear replacement visors 9 3/4" x 19" fits FIBF400 and FIBF500 series	EA	\$9.39
FIB4199DRK	Green replacement visors 9 3/4" x 19" fits FIBF400 and FIBF500 series	EA	\$9.61
FIB4199IR/UV	Shade 5 replacement visors 9 3/4" x 19" fits FIBF400 and FIBF500 series	EA	\$20.65



### B. Cap Peak Mounted Faceshields

Lightweight, dielectric faceshield protective cap mounting bracket mounts on the front peak of the cap. Dual channel mounting system uses one channel to anchor the bracket to the cap while the other channel holds the window so it can lock into the work position and pivot up and out of the way when not needed. The locked channels form a positive seal to keep debris from filtering between the cap and faceshield. Molded from strong, heat-resistant Noryl, ideal for extended outdoor use.

SKU	Description	UOM	Price
FIBFM70	Faceshield bracket, cap style	EA	\$10.92
FIBFM71	Faceshield bracket, full brim style	EA	\$10.92
FIB4178	Clear replacement visors 8" x 16.5"x .060	EA	\$5.71
FIB4178DGR	Green replacement visors 8" x 16.5"x .060	EA	\$5.95
FIB4178IR/UV	Shade 5 replacement visors 8" x 16.5"x .060	EA	\$16.66

### C. Dual Crown Faceshield with Chin Guard

North is pleased to introduce our new Fibre-Metal brand Clear Chin Guard for all Dual Crown Faceshields. This new clear poly carbonate chin guard will provide our customers with an even better option for cutting and grinding applications by increasing their field of vision.

SKU	Description	Type	UOM	Price
FIBFM5400DC	Dual Crown Faceshield with chin guard	Speedy Mounting Loop	EA	\$31.70
FIBFM4400DC	Dual Crown Faceshield with chin guard	4001 Quick Lock Caps	EA	\$30.67
FIBFM400DC	Dual Crown Faceshield with chin guard	Ratchet Gear	EA	\$34.29
FIBFM3400CGC	Chin Guard Clear		EA	\$6.67



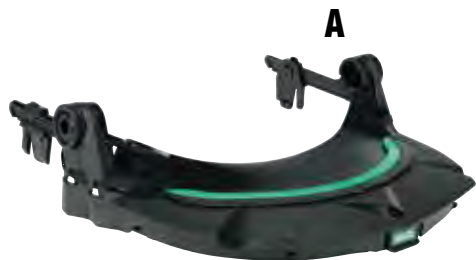

### A. V-Gard Frame For Slotted MSA Caps

This frame works with any MSA slotted or non-slotted helmet and features our unique sloped design to help material slide off the frame and out of site. Can be used with earmuffs, half-mask respirators and other personal protective equipment. Stays securely on the cap, thanks to the heavy-duty, flat, rubber strap. The elevated temperature model withstands temps up to 350°F (176°C). Each frame meets the applicable requirements for ANSI/ISEA Z87.1-2010

SKU	Description	UOM	Price
MSA10115730	V-Gard Frame for MSA slotted caps, with debris control	EA	\$10.55

### B. V-Gard Universal Frame For Slotted or Non Slotted MSA Caps

This frame works with any MSA slotted or non-slotted helmet and features our unique sloped design to help material slide off the frame and out of site. Can be used with earmuffs, half-mask respirators and other personal protective equipment. Stays securely on the cap, thanks to the heavy-duty, flat, rubber strap. The elevated temperature model withstands temps up to 350°F (176°C). Each frame meets the applicable requirements for ANSI/ISEA Z87.1-2010

SKU	Description	UOM	Price
MSA10121268	V-Gard Universal Frame for caps, without debris control	EA	\$7.53



### C. V-Gard Visors

These visors are made of durable polycarbonate or mesh, and help protect wearers from flying debris, splash or spray. All V-Gard Visors for general purpose can be worn with cap-mounted earmuffs.

SKU	Description	UOM	Price
MSA10117783	Visor clear, PC flat, nitrometer (non-CSA version) 8" x 17" x .06"	EA	\$6.02
MSA10115853	Visor clear, PC molded, AF/AS, 10.375" x 17" x .098"	EA	\$23.04
MSA10116558	Visor mesh with plastic edge, nitrometer, 8" x 17"	EA	\$81.53
MSA10115856	Visor clear propionate, molded, nitrometer	EA	\$12.77

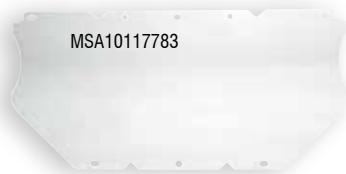

### D. Retractable Chin Protector

Unique retractable plates allow greater flexibility of head movement both up and down, as well as side-to-side. Opaque material ensures safety and standards compliance with clear, tinted, shaded and coated V-Gard Visors. 3.82" (9.7 cm) in height, when unretracted.

SKU	Description	UOM	Price
MSA10115828	Retractable Chin Protector	EA	\$7.75





### A. Universal Foldback Faceshield Frames

These Universal Foldback Faceshield Frames are designed to fit on any of MSA's protective hats. When properly positioned, they will securely hold faceshields, visors and welding shields. A durable ring of rubber tubing holds the plastic adapters securely on the hat while a metal spring holds the metal brackets in place. The plastic adapters are non-conducting, and can be worn on dielectric hats without affecting the headwear's dielectric qualifications.

SKU	Description	UOM	Price
MSA488159	Metal foldback faceshield frame, hat model (less visor)	EA	\$12.33
MSA488160	Metal foldback faceshield frame, cap model (less visor)	EA	\$11.52
MSA488132	Clear polycarb faceshield 8" x 16" x .06	EA	\$7.96
MSA10005882	Shade 5 green propionate faceshield 8" x 15 1/2" x .04	EA	\$33.42



MSA488159



### B. Sellstrom® DP4™ Multi-Purpose Faceshield

The new DP4 faceshield combines a clear anti-fog window with a flip-down IR window, providing uninterrupted protection for grinding, cutting, and brazing operations. The shield curves naturally to fit facial contours; ensuring reliable protection from splash, particles, and flying debris. Ratchet headgear suspension allows user to adjust size and tighten at the turn of a knob. Rugged, polycarbonate shield is impact and splash resistant. Meets ANSI Z87.1 standards and is CUL-certified to meet CAN/CSA-Z94.3 standards.

SKU	Description	Lens	UOM	Price
SEL32010	Multi-purpose faceshield	Clear	EA	\$34.14
SEL32151	Multi-purpose faceshield w/5 IR flip up window	Clear	EA	\$50.07
SEL32155	Replacement 5 IR flip up window	5 IR	EA	\$16.23
SEL32130	Replacement faceshield lens	Clear	EA	\$27.78



### C. 3M™ Faceshield System

An economical system that offers full-face protection. Innovative window system eliminates snaps, cams or bands... allowing replacements in seconds. The crown protector is made of new high-strength thermoplastic, for impact resistance over a wide range of temperatures. High-density polyethylene suspension has adjustable pin-lock mechanism to fit different head sizes. Crown strap also adjusts for additional support and comfort.

SKU	Description	UOM	Price
A082501	Tuffmaster H8A Headgear with crown protector	EA	\$13.76
A082700	Faceshield, propionate .080" X 9" X 14"	EA	\$6.25
A082701	Faceshield, polycarbonate .08" X 9" X 14"	EA	\$6.03



**WARNING!**

These eye and face protection products help provide limited eye and face protection. Misuse or failure to follow warnings and instructions may result in serious potential injury, including blindness or death. For proper use, selection, and applications against flying particles, optical radiation and / or splash see supervisor, read User Instructions and warnings on the package or call 3M OH&ESD Technical Service in the USA at 1-800-243-4630. In Canada, call 1-800-267-4414.





**A**

### A. Bionic™ Faceshield

The Bionic Faceshield offers enhanced protection from airborne debris while providing excellent optics and increased visibility. The visor is easily replaceable and has dual position choices. The lightweight and balanced, ergonomic design makes this faceshield ideal for extended use. Other features include a comfortable cell foam on back of headgear and a breathable, removable, washable headband. It can be worn comfortably with most goggles and respirators. Faceshield offers secondary protection and must be worn with spectacles or goggles. Passes ANSI Z87+ and CSA Z94.3 standards.

SKU	Description	UOM	Price
S8500	Bionic faceshield, clear uncoated	EA	\$24.47
S8550	Bionic replacement visor, clear uncoated	EA	\$5.33



### B. ProGuard™ System

Elvex top of the line ProGuard System comes equipped with a six point ratchet suspension safety helmet. This model is equipped with Elvex heavy duty cap-mount ear muffs, which provide a Noise Reduction Rating of 27 dB, and Visor Bracket and nylon visor.

SKU	Description	UOM	Price
ELVECU-60	ProGuard System	EA	\$55.27



**B**



### C. Safe-T-Rak®

Easily installs and adjusts to fit most hard hats, even the wide brim designs. Economical way to comply with recommendations for Carrying and Storage of Head Protection (ANSI Z89.1-1986). Protects your safety hard hats and caps from degradation caused by sunlight or damage caused by careless storage. The seat model fits over most vehicle seats and provides easy access to hard hat.

SKU	Description	UOM	Price
SIP002	Seat mount	EA	\$9.81



**C**



### D. Deluxe Helmet Storage Bag

Rugged polyester outer shell with fleece inside is built to protect helmets and shields from scratches. Added features include a breathable PVC mesh covering, drawstring closure and carrying strap designed to be used over the shoulder or for hand carry. Zippered inside and outside pockets allow extra storage for lens protectors and accessories. Hook is provided to hang bag when stored and drain hole is at base of bag. Clear plastic window pouch for personal identification. Will accommodate all sizes of helmets. Size: 13 1/2" cylinder

SKU	Description	UOM	Price
ALLE2025-05	Deluxe helmet storage bag	EA	\$31.49



**D**

# Instrumentation

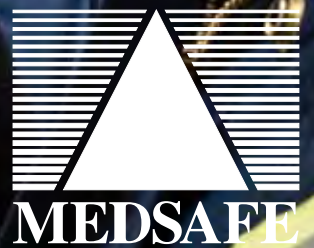
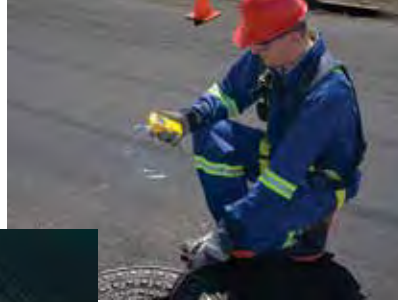



**A**

### A. GasAlertMax XT II Multi-Gas Detector

The GasAlertMax XT II portable multi-gas detector simultaneously monitors and displays up to four gases including hydrogen sulfide (H<sub>2</sub>S) carbon monoxide (CO), oxygen (O<sub>2</sub>) and combustibles (%LEL). The compact and field tough GasAlertMax XT II features an integrated sampling pump designed for performance and reliability. SmartSample pump technology prevents moisture from entering pump and saves time with reliable pump block detection. One-button operation guarantees ease of use even while wearing gloves. Tamper-proof, user adjustable options enable the instrument to be customized to suit your specific application.

SKU	Description	Sensors	UOM	Price
BWXTXWHMYNA	Gas Alert Max XT II 4 gas detector	LEL,O <sub>2</sub> ,CO,H <sub>2</sub> S	EA	\$887.96

### B. GasAlertQuattro Multi-Gas Detector

Rugged and reliable, the GasAlertQuattro combines a comprehensive range of features with simple one-button operation. The GasAlertQuattro displays real-time gas concentrations readings for up to four gas hazards including H<sub>2</sub>S, CO, O<sub>2</sub> and combustible gases. With a durable exterior, reinforced bumpers and a built-in concussion-proof boot, the GasAlertQuattro was designed for harsh, industrial environments. The GasAlertQuattro is always ready for your shift with interchangeable power options - AA batteries or a rechargeable battery pack. The extra large graphic LCD displays a range of easy to identify icons that indicate operational information such as bump test and calibration icons for simplified onsite auditing.

SKU	Description	Sensors	UOM	Price
BWQTXWHMAYNA	GasAlertQuattro NA version, Alkaline, Yellow	O <sub>2</sub> ,LEL,H <sub>2</sub> S,CO	EA	\$701.28
BWQTXWHMRYNA	GasAlertQuattro NA version, Rechargeable, Yellow	O <sub>2</sub> ,LEL,H <sub>2</sub> S,CO	EA	\$761.83

**B**



**C**



### C. GasAlertMicro 5 Multi-Gas Detector

The GasAlertMicro 5 portable gas detector simultaneously monitors and displays up to five potential atmospheric hazards including oxygen, combustible gases and a range of toxic gases. With an IP65/66 rating to ensure dust and water resistance, the GasAlertMicro 5 comes with audible, visual and vibrating alarms that activate in the event of a Low, High, TWA or STEL alarm condition. User selectable field options include confidence beep, pass code protection, latching alarm, calibration due date, "SAFE" display function, stealth mode, selectable ppm resolution for some gases (e.g. SO<sub>2</sub> 0.1 ppm). Other features of the GasAlertMicro 5 include an integral concussion-proof enclosure, two power options (three AA alkaline batteries or a rechargeable battery packs), multi-language support, and simple automatic calibration procedure compatible with BW's MicroDock II system. Each monitor is available with optional rechargeable battery pack, motorized pump, datalogging and confined space kit. Two year warranty including all sensors (1 year NH<sub>3</sub>,Cl<sub>2</sub>,O<sub>2</sub>,ETO and ClO<sub>2</sub> sensors).

SKU	Description	Sensors	UOM	Price
BWM5-XWOY-R-	GasAlertMicro 5 monitor	LEL,O <sub>2</sub> ,CO,H <sub>2</sub> S	EA	\$1392.28
BW58L-425	Calibration gas - 58L		EA	\$267.00



### A. GasAlertMicro 5 PID Multi-Gas Detector

Compact and lightweight, the GasAlertMicro 5 PID with a humidity resistant PID sensor measures for PID detectable volatile organic compounds (VOCs) while simultaneously monitoring and displaying up to four additional atmospheric hazards including oxygen, combustibles and a range of toxic gases. Available as a diffusion or pumped instrument, the GasAlertMicro 5 PID is fully customizable to suit any application with a wide range of user options.

- Two power options: AA alkaline or rechargeable hot-swappable battery packs
- Dust and water resistant design with IP 65/67 rating
- Rugged and durable, with a built-in concussion-proof boot
- Visual, audible and vibrating alarms
- Multi-language support in English, French, German, Spanish and Portuguese
- Automatic calibration procedure; compatible with BW MicroDock II automatic test and calibration station

SKU	Description	Sensors	UOM	Price
BWM5PIDXWQY	GasAlertMicro 5 PID	PID,LEL,O2,CO,H2S	EA	\$2061.23
BWM5PIDXWQSR	GasAlertMicro 5 PID	PID,LEL,O2,S02	EA	\$2110.18
BWM5PIDXWQYR	GasAlertMicro 5 PID	PID,LEL,O2,COSH	EA	\$2061.23
BW58L-425	Calibration quad gas - 58L		EA	\$267.00
BWCG2IB10058	Calibration gas - Isobutylene		EA	\$213.60
AIRL2001	DFR2000 demand flow regulator		EA	\$342.38
PPC920MED	Medsafe silver case 16.7L x 13.4W x 6.8H		EA	\$116.32

**A**



**B**

### B. GasAlertMicroClip Series

The industrial GasAlertMicroClip is the world's most popular multi-gas portable detector, delivering long runtime and reliability, plus small size, low cost and the easiest user experience. Compact, lightweight and easy to use with one-button operation and no extensive training. Features a rechargeable battery, survives harsh temperatures, punctures and 20-foot drops. Flashing green IntelliFlash™ light for compliance at a glance. Reflex™ Technology ensures sensor responsiveness for safety, uptime and worker confidence

SKU	Description	Sensors	UOM	Price
BWMCXLXWHMYN	GasAlertMicroClip XL standard operation with 2 year warranty	O2/LEL/CO/H2S	EA	\$683.26
BWMCXLXWHOYN	GasAlertMicroClip XL standard operation with 2 year warranty	O2/LEL/H2S	EA	\$617.04
BWMCXLXWOMYX	GasAlertMicroClip XL standard operation with 2 year warranty	O2/LEL/CO	EA	\$617.04
BWMCXLXW00YN	GasAlertMicroClip XL standard operation with 2 year warranty	O2/LEL	EA	\$516.19
BWMCXLX000YN	GasAlertMicroClip XL standard operation with 2 year warranty	O2	EA	\$390.00
BWMCXL00HMY	GasAlertMicroClip XL standard operation with 2 year warranty	H2S/CO	EA	\$516.19
BWMCX3XWHMYN	GasAlertMicroClip X3 extended operation with 3 year warranty	O2/LEL/CO/H2S	EA	\$731.25

### C. BW Clip

The BW Clip maintenance-free single-gas detector is the most reliable, user-friendly, cost-effective way to keep workers safe and operations compliant. It delivers up to three years of protection with no need for calibration, sensor replacement, battery replacement or battery charging. Features automated self-test for improved safety. Automatically logs the 35 most recent gas events for easy, accurate record keeping. Compatible with the IntelliDoX instrument management system for extremely quick bump tests, bump test tracking, adjustable set points and more. Also compatible with MicroDock II docking station and Fleet Manager II software.

SKU	Description	UOM	Price
BWC2-H	BW Clip 2 year monitor H2S	EA	\$195.00
BWC2-M	BW Clip 2 year monitor CO	EA	\$195.00
BWC2-S	BW Clip 2 year monitor SO2	EA	\$318.00
BWC2-X	BW Clip 2 year monitor O2	EA	\$195.00

**C**





**A**



### A. MicroDock II

The most cost effective way to manage the calibration and bump testing of BW Technologies by Honeywell portable gas detectors.

**Features & Benefits:**

- Quick and easy compliance - automatically maintain accurate records
- Automatic bump testing, calibration, record keeping and charging
- One base station with one AC outlet supports up to six modules to suit your application
- Verifies proper performance of detectors
- Reduces maintenance costs

**Quick Specs:**

- Size 8.3 x 10.4 x 3.2 in. / 21.2 x 26.3 x 8.2 cm (base station plus one docking module)
- Power supply 6V wall adaptor or four C-cell batteries
- Real-time clock Provides time and date stamp for "last calibration" and "last bump test" data
- Data storage Automatic (instrument and base station)
- MultiMediaCard data storage system

**Please call (800)330-9240 for Configuration and Pricing**

### B. IntelliDoX

IntelliDoX is an instrument management system for the BW Clip, bringing a new level of customization to maintenance-free gas detection. Combining smart docking modules and Fleet Manager II software, the system helps you drive productivity, reliability and efficiency, while configuring BW Clip detectors to meet changing requirements.

**Features:**

- Enables bump test tracking, email notices and easy recordkeeping for improved compliance
- Performs the quickest bump test in the industry for increased uptime and no wasted calibration gas
- Enables the ability to change alarm set points, set a noncompliance indicator when a bump test is due, and adjust other parameters on the BW Clip for maximum flexibility

**Quick Specs:**

- Easy setup with a network or USB drive no tools required
- Expandable to five docking modules that can operate independently, while sharing power, network connection and calibration gas
- Easy data transfer by Ethernet or USB from docking module to computer

SKU	Description	UOM	Price
BWDX-CLIP	IntelliDoX docking station for BW Clip	EA	\$2195.00
BWDX-ENBL-NA	IntelliDoX enabler kit North American version	EA	\$250.00

**B**

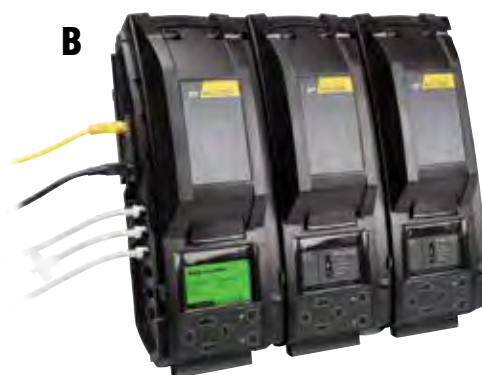

**C**



### C. Calibration Accessories

SKU	Description	UOM	Price
AIRL2001	DFR 2001 regulator	EA	\$342.38
BW58L-425	Cal Gas 2.5%METH,18%O2,100CO,25 H2S	EA	\$267.00
AIRL103L-248	Calibration gas isobutylene 100PPM	EA	\$218.66



### A. Sirius® Multigas Detector

The Sirius® Multigas Detector offers the ultimate in flexibility by integrating a high-performance PID (Photoionization Detector) and 4-gas detection into one. Users are able to simultaneously monitor volatile organic compounds (VOCs) with low vapor pressures while measuring for combustible, toxic, and oxygen-deficient atmospheres in one reliable, easy-to-use and durable unit. Applications include homeland security, confined spaces, leak detection, perimeter monitoring and many more. Features Include user-friendly software, flexible configurations, attention-getting alarm, interchangeable battery packs, and reliable PID performance. Assemble to order system allows you to configure monitor with options that you need. Compatible with MSA Galaxy® Automated Test System.

SKU	Description	Sensors	UOM	Price
MSAASIRIUSAT	Sirius Multigas Detector	LEL, O2, CO, H2S	EA	\$5001.55

A



B

### B. ALTAIR® 4X Multigas Detector

The ALTAIR 4X Multigas Detector for LEL, CO, H2S and O2 is as tough and functional as it looks. A rugged housing provides unsurpassed durability, including the ability to survive a 20-foot drop. MSA XCell Sensors are a breakthrough in chemical and mechanical sensor design, enabling faster response and span calibration times. With less time spent on calibration and bump tests, you save calibration gas, maintenance costs and, in turn, save money. Exclusive safety features like MotionAlert™ and InstantAlert™ make the ALTAIR 4X Multigas Detector ideal for applications like confined space entry. The MotionAlert sensor activates when a user becomes disabled and motionless, quickly alerting others to the disabled user's location.

SKU	Description	Sensors	UOM	Price
MSA10107602	ALTAIR 4X Multigas monitor	LEL, O2, CO, H2S	EA	\$1134.04

### C. ALTAIR® 5X Multigas Detector

MSA's ALTAIR 5X Multigas Detector provides many options to fit various applications. The detector is configurable with either a high-resolution color or monochrome LCD display with multilingual capabilities. MSA's Logo Express® Service option is available to customize the color display. The detector is easily configurable with interchangeable plug-and-play sensor slots for MSA XCell Sensors. Up to six gases can be monitored simultaneously.

Furthermore, this multigas detector offers optional glow-in-the-dark instrument housing for IR sensor-equipped units. The ALTAIR 5x Multigas Detector's lithium-ion battery lasts up to 20 hours, allowing it to be used over multiple shifts.

SKU	Description	Sensors	UOM	Price
MSA10116926	ALTAIR 5X Multigas monitor	LEL,CO,O2,H2S	EA	\$2513.42

C

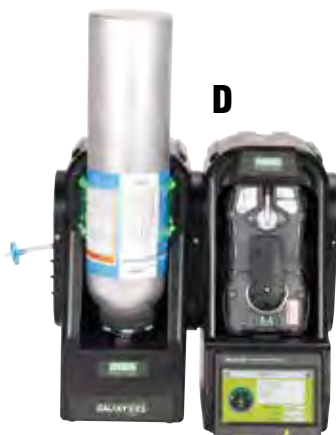

D

### D. GALAXY® GX2 Automated Test System

The GALAXY GX2 Automated Test System allows users to configure many gas detector and cylinder settings at the test stand, settings that can be saved to a reusable file. Settings are stored on a digital-secure USB; no gas detector setting files are stored locally. Your ALTAIR 4X and ALTAIR 5X Multigas Detectors are available to use immediately. If you're faced with an urgent, short-notice situation, these units are ready for deployment, ideal for emergency applications.

SKU	Description	UOM	Price
MSA10128642	GALAXY GX2 ALTAIR4/4X 1 Valve NA	EA	\$2235.37
MSA10128628	GALAXY GX2 ALTAIR5/5X 1 Valve, NA	EA	\$2235.37
MSA10128644	GALAXY GX2 ALTAIR/PRO 1 Valve NA	EA	\$2235.37
MSA10127422	Charger Multi Unit GX2 ALTAIR 4X NA Plug	EA	\$354.38
MSA10127427	Charger Multi Unit GX2 ALTAIR 5X NA Plug	EA	\$354.38

### E. Calibration Accessories

SKU	Description	UOM	Price
AIRL2001	DFR 2001 regulator	EA	\$342.38
AIRL4210	Regulator trigger style .25 LPM with pressure gauge	EA	\$207.19
MSA58L-416	Calibration Gas, CO-60,H2S-20,LEL-Pentane-58%,O2-15% 58L BAL Nitrogen	EA	\$268.76
AIRL103L-248	Calibration gas isobutylene 100PPM	EA	\$218.66



E







### A. RKI Eagle 2

The EAGLE 2 available features include a PID sensor for detecting high or low ppm levels (0-50 & 0-2,000) of VOC gases; % volume capability for CH<sub>4</sub> and H<sub>2</sub> using a TC (thermal conductivity) sensor; PPM or LEL hydrocarbon detection at the push of a button; infrared sensors for CO<sub>2</sub> (ppm or % volume), methane or hydrocarbons in LEL and % volume ranges; methane elimination feature for environmental applications; and a variety of super toxic gases. The EAGLE 2 has a strong internal pump with a low flow auto pump shut off and alarm, which can draw samples from up to 125 feet. This allows for quick response and recovery from distant sampling locations. The EAGLE 2 will continuously operate for over 18 hours on alkaline batteries or 20 hours on NiMH. A variety of accessories are also available to help satisfy almost any application such as long sample hoses, special float probes for tank testing, and dilution fittings, just to name a few. Datalogging is a standard feature for all sensors on all versions.

With its ergonomic design and large glove friendly buttons, the EAGLE 2 offers easy access to controls such as autocalibration, alarm silence, demand zero, peak hold, methane elimination, and a wide variety of other features. Each channel has two alarm levels plus TWA and STEL alarms for toxic channels. The two alarm levels are user adjustable and can be latching or self resetting. Rugged, reliable, easy to operate and maintain, the EAGLE 2 is the solution for just about any portable gas monitoring situation. Also, the display can be set to any of 5 languages: English, French, German, Italian, or Spanish.

SKU	Description	Sensors	UOM	Price
RKI725101P25	Eagle 2 CSK	LEL/O2/H2S/CO/PID VOC 0-2000	EA	\$5477.50
RKI725101P15	Eagle 2 CSK	LEL/O2/H2S/CO/PID VOC 0-50	EA	\$5938.33
RKI725001IRC	Eagle 2 IR 0-100%	LEL/CH4/O2/H2S/CO	EA	\$4323.88
RKI726-017	Eagle 2	LEL/O2/H2S/CO/NH3/SO2	EA	\$3844.17
RKI724-001	Eagle 2 with alkaline battery	LEL/O2/H2S/CO	EA	\$2794.17



A

#### Features

- Monitor up to 6 different gases
- PPM, % LEL, or % Vol. auto-ranging combustible detection
- Specialty Sensors
  - » PID (Photoionization Detector)
    - Low or high range for VOC detection
    - Fence Electrode Technology for humidity and contamination resistance
  - » Infrared (IR)
    - CO<sub>2</sub>, % LEL CH<sub>4</sub>, % Vol. CH<sub>4</sub>, % LEL HC, % Vol. HC
  - » Thermal Conductivity (TC)
    - % Vol. H<sub>2</sub>, % Vol. CH<sub>4</sub>
- » Smart toxic, plug and play sensors  
NH<sub>3</sub>, AsH<sub>3</sub>, Cl<sub>2</sub>, HCN, PH<sub>3</sub>, & SO<sub>2</sub>
- Multilingual (5 languages)
- Powerful long-life pump up to 125' range
- Low flow pump shut off and alarm
- Methane elimination for environmental use
- Alkaline 18 hours or NiMH 20 hours capability
- Password protection
- Datalogging standard
- Autocalibration / single gas calibration
- Internal hydrophobic dust filter
- External probe with hydrophobic filter
- Ergonomic RFI / EMI / chemical / weather resistant enclosure
- Intrinsically safe design, CSA approval

### B. Eagle 2 Calibration Station

The SDM-E2 is a versatile maintenance tool for the Eagle 2 portable gas monitor. This docking station can be used as a stand-alone device for charging, calibration and bump testing, with all records automatically stored for future upload to a PC via USB flash drive (PC software and flash drive included).

#### Multi Module System

The SDM-E2 can also be connected to a PC for automated calibration bump testing and archiving of datalog data from Eagle 2 instruments. Up to ten SDM-E2 docking stations can be connected simultaneously using USB cables. The SDM-E2 is also equipped with two gas ports to connect up to two calibration gas mixtures to the multi module system.

SKU	Description	UOM	Price
RKISDM2	Eagle 2 Calibration Station	EA	\$2250.00

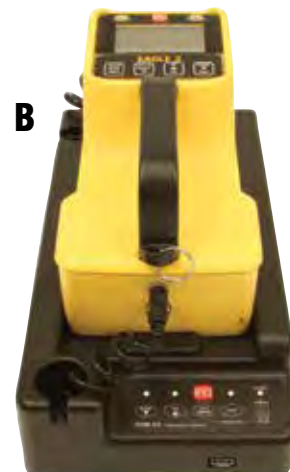

B



## A. RKI M2 Stand Alone Transmitter

The RKI M2™ is a state-of-the-art transmitter that can operate as an independent, stand-alone system or as part of an integrated system. The M2 connects with an analog or digital signal to virtually any controller, PLC, or DCS. Setup procedures are simplified with user friendly push buttons and LCD menus. It utilizes a magnetic wand technique for performing non-intrusive calibration. The M2 provides an automatic zero drift correction feature, which results in more stable readings and reduces the need for adjustments due to sensor aging.

The housing of the M2 does not need to be opened for zeroing or calibration, making it unnecessary to declassify the area for routine maintenance. It is designed so that a complete field calibration can be performed by one person. Sensor construction is rated Class I, Div. 1 groups B, C, D for flammables, CO, H<sub>2</sub>S, O<sub>2</sub>, and CO<sub>2</sub>, and Class I, Div. 2 for all other toxics.

### Features

- Operates with or without a controller
- Direct digital readout on backlit LCD
- Infrared sensor for combustibles and CO<sub>2</sub>
- 4-20 mA & digital Modbus outputs standard
- 2 fully programmable alarm relays & fail relay
- Non-intrusive calibration via magnetic wand
- Explosion proof construction
- Patented water repellent sensor cover
- User friendly setup, push buttons & LCD menus
- Long-life sensors (2 + years typical)

SKU	Description	UOM	Price
RKI652610RK	M2 Transmitter, General LEL sensor, with J-Box, Explosion Proof	EA	\$1125.00
RKI652613RK-	M2 Transmitter, O <sub>2</sub> sensor, with J-Box, Explosion Proof	EA	\$1243.75
RKI652615RK0	M2 Transmitter, H <sub>2</sub> S 0-100 ppm sensor, with J-Box, Explosion Proof	EA	\$1243.75



## B. SafeAir® Vapor Monitor

The SafeAir badge provides an immediate visual indication in the presence of a specific chemical hazard. The sensor is constructed from a coated indicator layer providing homogeneous and stable color formation. The appearance of an “exclamation mark” warns the presence of the targeted hazard. There is no calibration, extra equipment or laboratory analysis required.

SKU	Description	UOM	Price
KMG38201050	Ammonia monitor	50/PK	\$195.88
KMG38200950	Chlorine monitor	50/PK	\$195.88
KMG38201550	Hydrogen sulfide monitor	50/PK	\$195.88



## C. 3M™ Personal Air Monitoring Systems

Single carbon sorbent wafer for easy collection of vapors. Analysis by gas chromatography. Sampling and analysis guide for over 125 vapors available. 18-month shelf life.

SKU	Description	UOM	Price
3M3500	Organic vapor monitor	10/PK	\$201.15
3M3510	Organic vapor monitor w/analysis	5/PK	\$641.20
3M3551	Ethylene oxide vapor monitor	5/PK	\$137.43

IMPORTANT: The 3M products in this catalogue must be used in accordance with OSHA regulations, and the user instructions, warnings, and limitations accompanying each product.





ISO 9001:2008 CERTIFIED



## Innovation Leader

PortaGas has developed a recyclable cylinder program utilizing a complete line of reusable, sustainable cylinders. This eliminates the cost and work associated with the current cylinder disposal process. The new PortaGreen cylinders can be conveniently returned to PortaGas for reuse using the  program. These cylinders are more compact and globally approved.

BW Calibration Gas			
SKU	Description	UOM	Price
BW58L-425	Calibration Gas, CO-100,H2S-25,LEL-Methane-2.5%,O2-18% 58L BAL Nitrogen	EA	\$267.00
Biosystems Calibration Gas			
AIRL54-9044E	Calibration Gas, CO-50,H2S-25,LEL-Propane-50%,O2-18% 58L BAL Nitrogen	EA	\$267.00
PORT10631000	Calibration Gas, SO2-10PPM 58L BAL Nitrogen	EA	\$232.55
MSA Calibration Gas			
MSA58L-416	Calibration Gas, CO-60,H2S-20,LEL-Pentane-58%,O2-15% 58L BAL Nitrogen	EA	\$268.76
PORT90301624	Calibration Gas Altari 5X, H2S 20PPM,CO60PPM,LEL58%,O2 15%, SO2 58L	EA	\$360.00
RKI Calibration Gas			
RKI81-0154RK	Calibration Gas, 25PPM H2S/50PPM CO/50%LEL CH4/12% O2 BAL N2,58L	EA	\$300.00
Calibration Gas For Instruments With PID			
AIRL103L-248	Calibration Gas, Isobutylene-100 103L BAL AIR	EA	\$218.66
Calibration Gas For Single Gas H <sub>2</sub> S Monitors			
AIRL58L-25	Calibration Gas, H2S-25PPM 58L BAL Nitrogen	EA	\$228.00
PORT90100919	Calibration Gas, H2S-25PPM 116L BAL Nitrogen	EA	\$252.50

\*Mandatory hazard charge to ship.

## Game Changing Innovation

- **Eliminates HAZMAT Liability** - Just hand empty cylinder to your carrier.
- **Easy To Return** - no paperwork, no packing, no valve to crush, no hole to drill - just strip and ship.
- **No Disposal Fees... No Return Fees...**
- **Reduced Cylinder Footprint**
- **Increased Shelf Life**

Portagas is one of the most trusted names in the safety industry for calibration gases and equipment. Portagas uses ISO certified manufacturing processes to insure you receive the highest quality of calibration gas available. Each cylinder comes with a Material Safety Data Sheet and Certificate of Analysis. Use the Portagas brand of calibration gases for all of your calibration gas needs.

### • QUALITY ASSURANCE

Each cylinder is labeled with a unique serial number providing full traceability. The stability of each mix is guaranteed. All gases are made to the highest accuracy with traceability to N.I.S.T.



### A. Gas Sampling Pump & Tubes

The Gastec Gas Sampling Pump is designed for optimum safety and convenience. Its one-stroke, piston design with flow finish indicator eliminates the risk of partial samples and is perfectly calibrated. It includes a built-in detector tube tip breaker with storage bin for safe tip disposal. It is intrinsically safe and has a lifetime warranty. The pre-calibrated, direct-read tubes offer distinct lines of demarcation for easier viewing and require no interpretation, dual scales, or color charts. Offering some of the broadest operating temperature ranges available, the tubes can be used in virtually any environment—from 32°F to 104°F. Gastec Gas Sampling Pumps should only be used with Gastec Detector Tubes. Gastec products are designed, manufactured, and calibrated to work together to ensure accurate readings. To maintain the highest level of quality, Gastec products are manufactured in ISO-9001 certified facilities.

SKU	Description	Range	UOM	Price
GASGV100S	Pump kit w/ indicator		EA	\$545.81
GAS122	Toluene	5-600 ppm	10/BX	\$89.18
GAS3H	Ammonia	0.2-32% vol.	10/BX	\$98.74
GAS3L	Ammonia	0.5-78 ppm	10/BX	\$87.23
GAS3LA	Ammonia	2.5-200 ppm	10/BX	\$87.23
GAS3M	Ammonia	10-1000 ppm	10/BX	\$89.81
GAS4LL	Hydrogen sulfide	0.25-120 ppm	10/BX	\$79.60
GAS60	Phenol	0.4-187 ppm	10/BX	\$93.67
GAS8LA	Chlorine	0.1-16 ppm	10/BX	\$87.28



**B**

# Gilian®

### B. Gilian Challenger® Air Flow Calibrator

Introducing the Challenger® air flow calibrator for verifying and calibrating industrial hygiene air sampling instruments and other air sampling devices. The Challenger® is accurate within 0.75% of reading and provides a LCD indication of Volumetric and Standard flow rate, barometric pressure and ambient temperature.

SKU	Description	UOM	Price
GIL811991103	Challenger air flow calibrator	EA	\$1967.11

# CASELLA

USA

### C. Casella Tuff Personal Air Sampling Pumps

The Tuff Standard model is well suited to simple and basic abatement monitoring with straight forward set flow rate using an external calibrator and start/stop mode of operation.

SKU	Description	UOM	Price
CEL303211/K1	Tuff 3 Plus kit with charger and case	EA	\$857.50



**C**



**A**

### A. Reed Weather Station

This weather station's measurements are transmitted up to 300 ft (100m) to indoor receiver/display. The exterior sensors are easily mounted on fences or roofs and data is transmitted from outdoor sensors to indoor receiver every 30 to 40 seconds. The receiver is powered by an AC/DC adapter (included). Display is switchable from imperial to metric measurements. Other features include the memory retaining maximum and minimum values and desk or wall mount. Functions: Date and time with alarm; Indoor and outdoor temperatures; Temperature alarm; Wind speed and direction; Wind chill; Relative humidity; Accumulated rainfall; Barometric pressure and trend; Forecasts the next 12 hours.

SKU	Description	UOM	Price
ITMDG950	Weather station	EA	\$170.33

### B. Reed Psychrometer

The ITM8706 and ITM8726 simultaneous display with %RH, temperature and dew point or wet bulb or external probe temperature\*. Features include: calculates T1-T2 (Air temperature - External probe temperature)\*, triple display with backlighting, Max/Min readings, and sensor cap closes to protect probe during storage. The 8726 also includes: built-in datalogger stores up to 99 data points, real time clock and retrieve Max/Min/Avg readings from stored data. Includes batteries.

\* Requires 87P6 temperature probe

SKU	Description	UOM	Price
ITM8706	Psychrometer, digital	EA	\$173.68
ITM8726	Psychrometer, digital w/datalogger	EA	\$148.04
ITM87P6	Temperature Probe for 8706 & 8726	EA	\$22.39

**B**



**C**



### C. Reed Humidity/Temperature Datalogger W/ LCD

The ITM8829 records up to 16,000 temperature and humidity readings. Features include: real-time clock stores data and time, °F or °C selectable, LCD display, logs data for days, weeks or months, programmable sampling rate from 1 second to 2 hours, three start modes: scheduled, immediate or magnetic, data is retained in non-volatile memory, user-defined min/max alarm settings, program by RS-232 serial port and Windows® compatible software and 60" cable with DB9 connector.

SKU	Description	UOM	Price
ITM8829	Humidity/temperature datalogger W/ LCD	EA	\$148.04
ITM8818	Datalogger software & cable For 8829	EA	\$60.96
ITM9801	Datalogger printer for 8829	EA	\$309.76

### D. Reed Thermo-Anemometer All-In-One W/ Air Volume Calculator

The ITM8906 simultaneous displays air velocity and temperature. It calculates air volume by keying in area dimension. Selectable wind speed units. Calculates average velocity values. Features include: continuous moving air velocity averaging of measurements for up to 2 hours, displays Min/Max/Avg velocity with temperature values, multi-point averaging up to 8 points, high-contrast, 4-digit LCD readout, RS-232 interface and data hold and auto power off. Includes hard carrying case and batteries.

SKU	Description	UOM	Price
ITM8906	Thermo-Anemometer all in one w/ air volume calculator	EA	\$235.12

**D**





### A. Reed Light Meter One Hand Operation

Auto-ranging, 0 to 20,000 Lux and user selectable Lux/Foot-candles. Features include: Min/Max and data hold function, auto shut off and zero adjustment button and over range and low battery indication. Battery included.

SKU	Description	UOM	Price
ITMLM81LX	Light meter one hand operation, 20,000LUX	EA	\$98.28



### B. Reed Light Meter

The ST1301 accurately displays light levels over a range of 0 to 50,000 Lux. Features include: user selectable Lux/Foot-candles, max and data hold function, auto shut off over range and low battery indication. Carrying case and 12V battery included.

SKU	Description	UOM	Price
ITMST1301	Light meter, 50,000 LUX	EA	\$98.28

### C. Reed Thermometer, Thermocouple

The ITMST610B accepts K-type thermocouples. Features include: accuracy to 0.5%, maximum Hold plus Data Hold, large LCD with backlight, user selectable °C or °F and user selectable 0.1°C or 1°C (0.1°F or 1°F) resolution. Includes 9V battery and holster. The ITMST612 dual input thermocouple thermometer provides differential temperature measurements. Features include: differential temperature (T1-T2) mode freezes display, Scan Function (T1, T2, T1-T2, Max, Hold....) direct or differential measurements to 0.1°C/ 0.1°F resolution, accuracy to 0.5%, display maximum reading plus Data Hold, large LCD with backlight, user selectable °C or °F and accepts K-type thermocouples. Includes 9V battery and holster.

SKU	Description	UOM	Price
ITMST610B	Thermometer, thermocouple single input	EA	\$110.72
ITMST612	Thermometer, thermocouple dual input	EA	\$272.44
ITMBS6	Tripod for ST-610B & ST-612 thermocouple	EA	\$73.40



### D. Casella Microtherm Heat Stress WBGT

The Microtherm WBGT from Casella CEL is an ergonomically designed, compact, and rugged instrument designed to monitor heat stress potential of personnel in hot working environments in accordance with ISO 7243. It is the first heat stress meter that offers real-time graphical display of data and also features an audible/visual alarm which allows the operator to make rapid decisions if required. PC software for retrospective data analysis is included.

SKU	Description	UOM	Price
CEL180042A	Microtherm heat stress monitor kit	EA	\$3208.34



### E. Casella Microdust Pro

The Microdust Pro from Casella CEL is a portable, real time monitor for assessing the concentration of suspended particulate matter. It is probably the most versatile instrument available with the ability to measure from 1µgm-3 to 2500 mgm-3.

SKU	Description	UOM	Price
CEL176000A	Microdust Pro particulate monitor kit	EA	\$4735.25







**A**

### A. Casella CEL-110/1 and CEL-110/2 Acoustic Calibrators

The CEL-110/1 and CEL-110/2 units are compact and ergonomically designed with simplicity and ease of use being the main priority. A simple keypad is provided for logical control of the unit's functions. Two versions are available fulfilling the accuracy requirements of ANSI and IEC in the new Class 1 and Class 2 categories.

SKU	Description	UOM	Price
CEL110/1	Acoustic calibrator dual level class 1	EA	\$904.17
CEL110/2	Acoustic calibrator single level class 2	EA	\$519.17

### B. Casella CEL-200 Series Sound Level Meters

The CEL-200 series are ideal instruments for simple workplace noise monitoring or general checks of noise levels from machines or from fire alarms etc. They feature the 'A' frequency weighting which simulates the typical hearing response of humans and have the slow and fast time weightings as specified in many international standards.

SKU	Description	UOM	Price
CEL240/K1	Digital sound level meter kit	EA	\$1044.17
CEL242/K2	Digital logging sound level meter kit with software	EA	\$1510.83
CEL244/K1	Digital integrating sound level meter kit	EA	\$1627.50
CEL246/K2	Digital logging integrating sound level meter kit with software	EA	\$2094.17



**B**



**C**

### C. Casella CEL-600 Series Full Color - Real Time Analyzers

The CEL-600 series is a brand new range of quality sound level meters aimed primarily at the industrial hygiene and safety user for the measurement of workplace noise. These new instruments feature the benefits of digital signal processing (DSP) technology to make them powerful yet very easy to use.

SKU	Description	UOM	Price
CEL620A2/K1	Sound level meter kit	EA	\$3535.00
CEL620B2/K2	Octave band sound level meter kit with software	EA	\$3838.33



### D. 3M™ Sound Detector SD-200

The 3M(TM) Sound Detector SD-200 includes key features for the assessment of workplace noise levels, including integration which computes the average sound pressure level. In addition, the SD-200 has LED indicators that flash green, yellow and/or red when preset thresholds have been reached. The rechargeable lithium polymer battery helps to lower the total cost of ownership versus other sound level meters that use replaceable batteries.

SKU	Description	UOM	Price
3MSD-200	SD-200 Sound Detector, USB Cable, Windscreen	EA	\$359.90

**WARNING**

Important: For appropriate use of hearing protection devices, consult your company's safety professional, applicable local standards or call 3M at 1-800-243-4630.



**D**

## A. OHD Optimus Sound Meters Kits

When you are making a noise measurement, the instrument you are using should not get in the way of getting reliable and useful information. The Optimus sound level meters have been designed with ease of use as the most important feature which lets you get on with measuring and controlling the noise. The instruments use the very latest in digital technology and industrial design techniques to make everything as clear and simple as possible. OHD used a high resolution colour OLED screen which can be seen in any conditions, and the keypad will illuminate automatically in low light. The case is robust and covered with a tactile finish so it can be used even if you're wearing gloves. The measurement data is displayed in a clear and simple format along with a realtime noise chart so that you can see how the noise varies with time. All of the functions of the instrument are measured simultaneously, and with a wide 120dB measurement span you don't need to worry about choosing the right range. An Optimus can measure up to 140dB(A) and 143dB(C) Peak in this single range. Just switch on, calibrate and you are ready to go.



### The Optimus Yellow - High Performance

The Optimus Yellow instruments are a range of state-of-the-art sound level meters that have been designed to meet the very latest standards for noise measurement instruments and provide the highest level of performance possible whilst being simple to setup, use and operate.

SKU	Description	Data Logging	Octave Band Filters	UOM	Price
OHDSLMCK152A	Optimus sound meter class 2 kit (yellow)			EA	\$3156.82
OHDSLMCK152B	Optimus sound meter class 2 kit (yellow)	✓		EA	\$3770.45

### The Optimus Red - Occupational Noise & Industrial Hygiene Noise

The optimus Red sound level meters are the ideal sound instruments for occupational noise and industrial hygiene measurements, as well as for basic noise surveys, and will give you all of the information you need, right at your finger tips.

SKU	Description	Data Logging	Octave Band Filters	UOM	Price
OHDSLMCK162B	Optimus sound meter class 2 kit (red)	✓		EA	\$4581.82
OHDSLMCK162C	Optimus sound meter class 2 kit (red)	✓	✓	EA	\$6040.91

### The Optimus Green - Environmental & Occupational Noise

The Optimus Green sound level meters are the ideal sound instruments for environmental & occupational noise, as well as for basic noise surveys, and will give you all of the information you need, right at your finger tips.

SKU	Description	Data Logging	1:1 Octave Band Filters	1:3 Octave Band Filters	UOM	Price
OHDSLMCK172B	Optimus sound meter class 2 kit (green)	✓	✓	✓	EA	\$8400.00

**A**



**B**



## B. DoseBadge

The OHD/Cirrus Research doseBadge Dosimeter is an innovative wireless noise dosimeter that is powerful, easy to maintain, and very cost effective. No wires to tangle and no unit to tamper with means accurate and safe measurements. Multiple badges can be controlled by one reader, which will turn the badges off and on via an infrared signal. The reader can download the data into the included doseBadge Database software for flexible and comprehensive reporting from your PC. Allow the doseBadge dosimeter to measure your noise with no wires and no hassles! The doseBadge is now available in an Intrinsically Safe version that has been approved by MSHA.

SKU	Description	UOM	Price
OHDSLMCK110A	DoseBadge system with 1 badge	EA	\$4731.82



**A**

### A. Casella CEL-300 Series Convertible Noise Dosimeters

The CEL-300 Series includes the CEL-320 and CEL-360 dosimeters which can be converted to the CEL-320S and CEL-360S sound level meters by simply exchanging the cable microphone assembly for a traditional stalk microphone and preamplifier. They are the ideal instruments for any form of personal worker surveys when considering the possible risk of hearing loss in the workplace. Conversion to a compact sound level meter enables comprehensive noise measurements to be carried out with the possibility of storage of the results for later recall from memory.

SKU	Description	UOM	Price
CEL320/K1	Noise dosimeter kit	EA	\$2061.50
CEL320IS/K1	IS noise Dosimeter kit	EA	\$2178.17
CEL360/K1	Logging noise Dosimeter kit	EA	\$2790.67

### B. Casella dBadge2 Personal Noise Dosimeter

The dbadge2 retains all the great features that made the CEL-35x series so successful but Casella has added powerful new capabilities that will completely change the way use dosimeters - to save you and your workers time, money and even prevent costly errors or mistakes - because they have revolutionized how personal dosimetry gets done! Imagine being able to view noise exposure data from multiple workers, REMOTELY right on your cellphone or tablet! That's right, now you can access each ANSI/IEC standards compliant dBadge2 dosimeter directly from your HHD using the built-in Bluetooth®4.0 connection and the Casella Airwave™ App!

SKU	Description	UOM	Price
CELD2K1	dBadge2 Noise Dosimeter 1 pack kit	EA	\$3184.21
CELD2K2	dBadge2 Noise Dosimeter 2 pack kit	EA	\$5007.01
CELD2K3	dBadge2 Noise Dosimeter 3 pack kit	EA	\$6829.81
CELD2K5	dBadge2 Noise Dosimeter 5 pack kit	EA	\$10247.56
CELD2K10	dBadge2 Noise Dosimeter 10 pack kit	EA	\$18222.31



**B**



### C. 3M™ Noise Indicator NI-100

Innovative and durable noise detection, the NI-100 noise indicator alerts you when noises in an area reach potentially hazardous levels. The noise indicator's small size and lightweight design make it ideal for workers in a variety of industries. With a rechargeable battery that operates for up to 200 hours between charges, it's an economical investment in your hearing conservation program. The NI-100 can be used as an effective training tool within a Hearing Conservation Program (consult OSHA Standard 1910.95) to help ensure workers know when and where to wear hearing protection. Safety and health professionals can also use it as a mapping tool to determine where noise studies are necessary. In a variable noise environment, the 3M noise indicator can help train workers as to when noise levels become potentially hazardous and hearing protection may be required.

- Red Flashing LED indicates noise levels are above 85 dBA and hearing protection may be required.
- Green Flashing LED indicates noise levels are below 85 dBA and hearing protection may not be necessary.

*\*The NRR may overestimate the hearing protection provided during typical use. 3M recommends reducing the NRR by 50% for estimating the amount of noise reduction provided. 3M is Leading the Advancement of Hearing Conservation™. 3M™ Noise Indicator NI-100 is not Intrinsically Safe.*

SKU	Description	UOM	Price
3MNI-100	Noise Indicator NI-100, 10/CS	CS	\$434.13

IMPORTANT: For appropriate use of hearing protection, consult your company's safety professional or applicable local safety standards

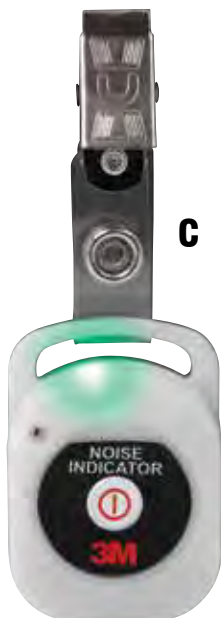

**C**





# Communications

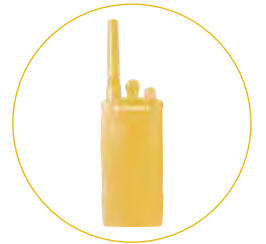

### CLS Series

Clear. Lightweight. Simple. Designed with business productivity in mind, Motorola CLS Series™ radios and headsets provide a communication solution that is not only smart, simple and reliable but also able to withstand the daily rigors of the workplace.



**A**

#### A. Motorola Two-Way Radios CLS Series

**Features:**

- 1 Watt power
- Up to 4 Channels
- 56 UHF business exclusive frequencies (FCC license required)
- Interference eliminator with 121 codes - 83 DPL & 38 PL
- 12 hrs battery life (based on 5/5/90 duty cycle)
- Meets Mil-Spec 810 C, D, E for drop and vibration
- LCD display screen
- "Call Alert" button with 4 tones, including vibrate
- Audio accessory jack - use with speaker mic and headsets

- VOX - Voice activated transmit with select audio accessories
- Cloning capability (requires 6 unit charger #56531)

**Range/Coverage:**

- Steel/Concrete Buildings: Up to 200,000 sq ft
- Multi-Level Buildings: Up to 15 floors

**Accessories Included:**

- Li Ion rechargeable battery
- 3 hr desktop charger
- Quick release swivel holster with belt clip

SKU	Description	UOM	Price
AXCLS1410	1410 UHF two-way radio, 1 watt, 4 channels	EA	\$194.19

### PR-400

When you need to be safe, the Motorola PR400, Intrinsically Safe Approved Portable Radio Unit, meets Factory Mutual approvals for safe operation in certain chemical or gaseous environments.

#### B. Motorola Intrinsically Safe (IS) Two-Way Radio PR-400

**Features:**

- Up to 4 Watts Power (1 Watt low power setting)
- Up to 16 Channels custom programmed by Access
- 9 Hrs battery life (4W, 5/5/90, battery save enabled)
- Designed to IP-55 and MIL-SPEC specifications
- Intrinsically Safe for use in Classes I, II, III, Division 1, Groups C,D,E,F,G
- Approved for non-incendive use in Class I, Division 2, Groups A,B,C
- 2 programmable buttons
- Dual priority scan
- X-Pand™ technology
- Programmable frequency range: UHF 438-470MHZ
- Large rotary channel selector
- Tri-color LED indicator

- Rugged, die-cast chassis with polycarbonate housing
- Large, textured push-to-talk button is easy to use even when wearing gloves
- Battery latch lock secures battery in case radio is dropped

**Range/Coverage:**

- Steel/Concrete Buildings: Up to 350,000 sq. ft.
- Multi-Level Buildings: Up to 30 floors

**Accessories Included:**

- Intrinsically Safe (FM) 1300 mAh NiMH battery
- 90-minute drop-in charging tray with wall adaptor
- 3" spring belt clip
- User's guide
- Warranty card

SKU	Description	UOM	Price
AXHK1847A	PR-400 Intrinsically Safe (IS) UHF Two-Way Radio	EA	\$746.62



**B**



**C**

#### C. Motorola PR-400 Radio 90Min Rapid Charger

Lightweight and compact charger with wall-mounted power supply rapidly charges Lilon, NiMH & NiCd batteries within 3 hours. Allows battery only or radio/battery combination charging. 90-min. Rapid Charger for the PR-400 Radio.

SKU	Description	UOM	Price
AXWPLN4138AR	Rapid Charger for the PR-400 Radio	EA	\$92.47



## RM Series

Motorola RM Series two-way radios have the business smarts to help people work better together – coordinating resources at the construction site or monitoring production on the manufacturing line. They come with the right credentials to give business the competitive edge: exceptional quality, affordability and durability to outlast high noise, tough conditions and hard use.

### A. Motorola On-Site Two-Way Business Radio RM Series

**Features:**

- 2 Watt power
- Up to 4 Channels
- Operates on 89 UHF business exclusive frequencies
- 219 PL/DPL codes, including 6 customizable codes to help ensure a clear signal
- Up to 15 hours with battery save on or up to 12 hours without battery save
- Meets military specifications for sealing against dust, wind, shock, vibration and other adverse conditions. These radios also undergo Motorola’s exclusive Accelerated Life Testing (ALT) that simulates up to 5 years of field use
- Tricolor LED interface allows users to identify radio features and status
- Powerful 1500 mW speaker ensures clear communication without distracting feedback in noisy conditions
- VOX - Enables hands-free operation with or without the use of optional accessories

- Quickly copies settings from radio to radio (between RM series radios or between RM and RDX series radios). Cloning is done with radio-to-radio cloning cable or through the multi-unit charger
- Antimicrobial Coating helps prevent the growth of mold and germs on the surface of the radio

**Range/Coverage:**

- UHF provides coverage up to 250,000 Sq. Ft./20 Floors. Coverage will vary based on terrain, conditions, and the radio model used.

**Accessories Included:**

- Carry holster with a swivel belt clip
- 2100 mAh Li Ion battery
- Compact drop-in charging tray with power supply
- User guide



SKU	Description	UOM	Price
AXRMU2040	RMU2040 UHF two-way radio, 2 watts, 4 channels	EA	\$245.00

### B. Motorola On-Site Two-Way Business Radio RM Series With Display

**Features:**

- 2 Watt power
- Up to 8 Channels
- Operates on 89 UHF business exclusive frequencies
- 219 PL/DPL codes, including 6 customizable codes to help ensure a clear signal
- Up to 15 hours with battery save on or up to 12 hours without battery save
- Meets military specifications for sealing against dust, wind, shock, vibration and other adverse conditions. These radios also undergo Motorola’s exclusive Accelerated Life Testing (ALT) that simulates up to 5 years of field use
- Tricolor LED interface allows users to identify radio features and status
- Powerful 1500 mW speaker ensures clear communication without distracting feedback in noisy conditions

- Antimicrobial Coating helps prevent the growth of mold and germs on the surface of the radio
- NOAA Weather Radio-(NWR) Channel 8 is pre-assigned to receive official National Weather Service warnings, watches, forecasts and other hazard information 24 hours a day, 7 days a week. The Weather Channel configuration can be customized based on geographic location.
- Quickly copies settings from radio to radio when used with accessory

**Range/Coverage:**

- Provides coverage up to 250,000 Sq. Ft./20 Floors. Coverage will vary based on terrain, conditions, and the radio model used.
- 2100 mAh Li Ion battery
- Compact drop-in charging tray and power supply
- User guide



SKU	Description	UOM	Price
AXRMU2080D	UHF two-way radio, 2 watts, 8 channels with display	EA	\$310.00





### RDX Series

The RDX Series radios perform well in harsh and noisy environments, generating 30% louder audio than the XTN and AX Series. Water proof and durable, a metal die cast chassis helps radios hold up under demanding conditions. Coverage varies by model, working effectively in up to 350,000 sq. ft., 30 floors.



#### A. Motorola RDX Series Industrial Two-Way Radios

**Features:**

- Up to 4 or 5 Watts Power (2W low power setting)
- Up to 10 channels
- 2 programmable buttons
- Repeater capable
- 39 analog and 83 digital interference eliminator codes
- 22 hrs battery life (4 or 5W, 5/5/90, battery save enabled)
- Meets Military 810, C, D, E and F and IP54/55 specifications for shock, rain, humidity, salt fog, vibration, sand/dust, temperature shock, high and low temperature
- 3 voice-inversion scramble settings to minimize eavesdropping
- Channel scan with selectable scan list
- 3 audible call tones
- 2 pin accessory plug

- VOX (hands-free use with accessories) with 3 sensitivity levels
- Tri-color LED display screen with transmit, receive, and low battery indication

**Range/Coverage:**

Steel/Concrete Buildings:

- RDU4100 - Up to 350,000 sq. ft.
- RDV5100 - Up to 300,000 sq. ft.

Multi-Level Buildings:

- RDU4100 - Up to 30 floors
- RDV5100 - Up to 18 floors

**Accessories Included:**

- 2400 mAh Li Ion rechargeable battery
- (Up to 22 hrs average daily use)
- 12 hr drop-in charging tray with wall adaptor
- 3" spring belt clip

SKU	Description	UOM	Price
AXRDU4100	RDU4100 UHF two-way radio, 4 watt, up to 10 channels	EA	\$341.99
AXRDV5100	RDV5100 VHF two-way radio, 5 watt, up to 10 channels	EA	\$308.74

#### B. Motorola RDX Series Industrial Two-Way Radios With Display

**Features:**

- Up to 4 Watts Power (2 Watts low power setting)
- Up to 16 channels with aliasing (up to 8 characters)
- 5 programmable buttons
- Repeater capable
- 39 analog and 83 digital interference eliminator codes
- 22 hrs battery life (4W, 5/5/90, battery save enabled)
- Meets Military 810, C, D, E and F and IP54/55 specifications for shock, rain, humidity, salt fog, vibration, sand/dust, temperature shock, high and low temperature
- 3 voice-inversion scramble settings to minimize eavesdropping
- Channel scan with selectable scan list
- 3 audible call tones
- 2 pin accessory plug
- VOX (hands-free use with accessories) with 3 sensitivity levels

- Tri-color LED display screen with transmit, receive, and low battery indication
- Battery gauge
- Signal strength indicator
- Keypad lock

**Range/Coverage:**

- Steel/Concrete Buildings: Up to 350,000 sq. ft.
- Multi-Level Buildings: Up to 30 floors

**Accessories Included:**

- 2400 mAh Li Ion rechargeable battery
- (Up to 22 hrs average daily use)
- 12 hr drop-in charging tray with wall adaptor
- 3" spring belt clip

SKU	Description	UOM	Price
AXRDU4160D	RDU4160d UHF two-way radio, 4 watt, 16 channels, with display	EA	\$361.00



**Accessories**
**A. Motorola RM Series Replacement Li-on Battery**

Replacement lithium ion battery for the RM Series Radios. 2150 mAH – Up to 15 hours with battery save on or up to 12 hours without battery save (battery capacity will differ depending on the radio model and/or region).

SKU	Description	UOM	Price
AXPMNN4434AR	Replacement Li-on Battery RM Series Radios	EA	\$70.19

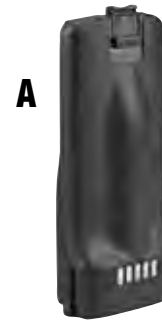
**B**

**B. Motorola RM Series Multi-Unit Charger**

Multi-unit charger for the RM Series radios. Allows drop-in charging of up to 6 units.

SKU	Description	UOM	Price
AXPMLN6384	Multi-Unit Charger RM Series Radios	EA	\$323.89

**C. Motorola RDX Series Ultra Capacity Li-on Battery**

Ultra high capacity lithium ion battery for the RDX Series Radios. 2400 mAh – Provides up to 26 hours of service (estimated only, with “battery save” feature “ON” – battery capacity will differ depending on the radio model and/or region).

SKU	Description	UOM	Price
AXRLN6308	Li Ion Battery for the RDX Series Radios	EA	\$104.49

**D**

**D. Motorola RDX Series Multi-Unit Charger**

Multi-unit charger for the RDX Series radios. Allows drop-in charging of up to 6 radios or batteries. Batteries can be charged with the radios or removed and placed in the MUC separately.

SKU	Description	UOM	Price
AXRLN6309	Multi-unit charger for the RDX Series Radios	EA	\$261.25

**E. Motorola Remote Speaker Microphone**

Remote Speaker Microphones are built and rigorously tested to the same quality standards as Motorola radios. They are ideal for professionals who need to talk and listen without removing the radio from the belt, case or charger. Remote speaker microphone compatibility with AX/RM/CLS/DTR/RDX/XTN radios.

SKU	Description	UOM	Price
AXHMN9026B	Remote speaker microphone CLS/DTR/RX/XTN	EA	\$65.00





### DTR Series

The DTR Series operate at 900 MHz and offer enhanced communication options, including Digital One-to-One Calling and Digital One-to-Many Calling (Public Group and Private Group). They also provide enhanced performance with greater coverage, longer battery life and digital audio quality that is loud and clear everywhere you have coverage.



**A**

### A. Motorola Digital Two-Way Radio DTR550

**Features:**

- 900 MHz ISM License-Free Band
- Digital one-to-many group call
- One-to-one private calling
- SMS messaging - 15 preset text messages
- Frequency Hopping Spread Spectrum (FHSS)
- Private-group calling - up to 10 private groups
- Public-group calling - 20 public groups
- Antenna: Stubby
- Battery gauge
- Li Ion battery - up to 14.5 hrs. operation / full charge; high capacity Li Ion battery available for up to 19 hrs. operation/ full charge
- 2 pin audio accessory jack with captive connector cover; takes 2 pin audio accessories – uses XTN/CLS audio accessories
- 3-hr. desktop charger
- Public group call name aliasing (via optional mini keyboard)
- Tough polycarbonate housing with rubber overmold for comfort

- Meets military standards MIL-STD 810 C, D, E, F for high resistance to dust, moisture, shock and vibration
- Connector programming interface with captive connector cover
- Full-graphic backlit display with contrast adjustment and backlight timer
- Daily alarm
- Caller ID
- VibraCall® - vibrate with no audio alert tones
- Recent call list - last 20 transmissions
- Up to 150 unit contact list
- Unit-to-unit configuration cloning (via optional cloning cable)

**Range/Coverage:**

DTR550 - Up to 325,000 sq. ft. and 30 floors

**Accessories Included:**

- Li Ion battery - standard capacity
- 3-hr plug-in charger
- Drop-in charging tray
- Swivel belt holster with 3" spring clip

SKU	Description	UOM	Price
AXDTR550	DTR550 digital two-way radio	EA	\$265.05

### B. Eartec Double Muff Headset

Headset to use in noisy areas without needing to remove radio from belt. Covers both ears to seal out ambient noise. Headband wraps around the back of head. Works on VOX equipped radios. For use with RM, RDX, XTN and CLS Series two way radios.

SKU	Description	UOM	Price
AXCETXTMOTOS	Eartec Double Muff Headset for hardhat wearers	EA	\$242.92



**B**



**MOTOROLA**

Authorized Business  
Two-Way Radio Reseller

MOTOROLA, MOTO, MOTOROLA SOLUTIONS and the Stylized M Logo are trademarks or registered trademarks of Motorola Trademark Holdings, LLC and are used under license. All other trademarks are the property of their respective owners. ©2014 Motorola Solutions, Inc. All rights reserved.





# Respiratory





### A. 3M™ Particulate Respirator 8210, N95

This respirator is designed to help protect workers against certain non-oil particles. It features Advanced Electrostatic Media, welded strap attachment, soft nose foam, and an adjustable noseclip to help ensure a custom and secure seal.

SKU	Description	UOM	Price
3M8210	Particulate respirator 8210, N95	20/BX	\$18.07

### B. 3M™ Particulate Respirator 8211, N95

This respirator offers all the great features of the 8511, plus a comfortable foam face seal. Its design helps protect against certain non-oil based particles.

SKU	Description	UOM	Price
3M8211	Particulate respirator 8211, N95	10/BX	\$35.35



### C. 3M™ Particulate Respirator 8511, N95

3M's most popular valved model, this respirator helps provide protection against certain non-oil based particles. Ideally suited for work situations involving heat, humidity, or long periods of wear.

SKU	Description	UOM	Price
3M8511	Particulate respirator 8511, N95	10/BX	\$23.37

### D. 3M™ Aura™ 9211+ Particulate Respirator, N95

An innovative three-panel respirator that's ideally suited for work situations involving heat, humidity, or long periods of wear. Designed to reduce eyewear fogging, the embossed top panel helps reduce the potential fogging of eyewear from warm, moist exhaled airflow. Sculpted top panel helps conform to nose and contours of the face and helps compatibility with eyewear. Chin Tab is designed for ease of positioning, donning and adjustment.

SKU	Description	UOM	Price
3M9211+	Particulate respirator 9211+, N95	10/BX	\$25.69



#### ⚠️ WARNING!



These respirators help reduce exposure to certain airborne contaminants. Before use, the wearer must read and understand the USER Instructions provided as a part of the product packaging. A written respiratory protection program must be implemented meeting all the requirements of OSHA 1910.134 including training, fit testing and medical evaluation. In Canada, CSA standards Z94.4 requirements must be met and/or requirements of the applicable jurisdiction, as appropriate. Misuse may result in sickness or death. For proper use, see packaging instructions, supervisor, or call 3M OH&ESD Technical Service in USA at 1-800-243-4630 and in Canada at 1-800-267-4414.



### A. 3M™ Particulate Respirator 8210V, N95

An economical option when a valved respirator is desired, this respirator is based on the popular 8210 and features the proprietary 3M™ Cool Flow™ Valve.

SKU	Description	UOM	Price
3M8210V	Particulate Respirator 8210V, N95	10/BX	\$14.13



### B. 3M™ Particulate Respirator 8293, P100

For those who want NIOSH's highest-rated filtration efficiency in a disposable respirator, this provides a minimum filter efficiency of 99.97% against oil-based particles.

SKU	Description	UOM	Price
3M8293	Particulate respirator 8293 P100	20/CS	\$205.63

### C. 3M™ Particulate Respirator 8233, N100

For those who want NIOSH's highest-rated filtration efficiency in a disposable respirator, this provides a minimum filter efficiency of 99.97% against **non-oil based** particles.

SKU	Description	UOM	Price
3M8233	Particulate respirator 8233, N100, Individually packaged	20/CS	\$182.02



#### Featured Technologies

3M's technological features help you match the right respirator to your environment. Use this color code to identify which features are included on each respirator.



**Advanced Electrostatic Media**  
Proprietary filter media with electrostatically charged microfibers designed for ease of breathing.



**Cool Flow™ Exhalation Valve**  
Proprietary one-way valve for easy exhalation and cool comfort.



**Faceseal**  
Soft and secure, conforms closely to face for additional comfort.



**P-Series Filter**  
Proprietary Advanced Electrostatic Media, appropriate for prolonged use in both oil and non-oil containing environments.

IMPORTANT: All 3M products shown in this catalog must be used in accordance with the OSHA regulations and the user instructions, warnings, and limitations accompanying each product.







**A**

### A. 3M™ Particulate Welding Respirator 8212, N95 with Faceseal

This option contains all of the features of the 8512 plus a comfortable foam faceseal.  
*Potential Applications: Welding, metal pouring.*

SKU	Description	UOM	Price
3M8212	Particulate respirator 8212, N95	10/BX	\$72.37



### B. 3M™ Particulate Welding Respirator 8515, N95

An economical option for welders. Features the 3M™ Cool Flow™ Valve, welding web, adjustable M-Noseclip, and braided headbands to help provide a custom and secure seal.

*Potential Applications: Welding, metal pouring.*

SKU	Description	UOM	Price
3M8515	Particulate welding respirator 8515, N95	10/BX	\$32.89



**B**



**C**

### C. 3M™ Particulate Welding Respirator 8514, N95

A respirator designed for applications where metal fumes are present, including those with ozone\* and nuisance level organic vapors.\*\*

*Potential Applications: Welding, particularly with stainless, galvanized and aluminum and metal pouring.*

SKU	Description	UOM	Price
3M8514	Particulate respirator 8514, N95	10/BX	\$75.31



### D. 3M™ Particulate Respirator 8214, N95

All the features of the 8514, plus a comfortable foam faceseal.\*

*Potential Applications: Welding, particularly with stainless, galvanized and aluminum, metal pouring.*

SKU	Description	UOM	Price
3M8214	Particulate respirator 8214, N95	10/BX	\$84.78



\* 3M recommended for ozone protection up to 10X OSHA PEL. Not NIOSH approved for ozone.  
 \*\* 3M recommended for relief against nuisance level acid gas or organic vapors. Nuisance levels are less than OSHA PEL or applicable government occupational exposure limits, whichever is lower.



**D**

#### ⚠️ WARNING!



These respirators help reduce exposure to certain airborne contaminants. Before use, the wearer must read and understand the USER Instructions provided as a part of the product packaging. A written respiratory protection program must be implemented meeting all the requirements of OSHA 1910.134 including training, fit testing and medical evaluation. In Canada, CSA standards Z94.4 requirements must be met and/or requirements of the applicable jurisdiction, as appropriate. Misuse may result in sickness or death. For proper use, see packaging instructions, supervisor, or call 3M OH&ESD Technical Service in USA at 1-800-243-4630 and in Canada at 1-800-267-4414.



### A. 3M™ Particulate Respirator 8577, P95, with Nuisance Level Organic Vapor Relief

This respirator helps provide comfortable, reliable worker protection against certain oil and non-oil based particles – including those with nuisance levels of **organic vapors\*** such as solvents, degreasers, and resins.

*Potential Applications: Foundry operation, lab settings, agricultural, petrochemical and manufacturing.*

SKU	Description	UOM	Price
3M8577	Particulate respirator 8577, P95, with Nuisance Level Organic Vapor Relief	10/BX	\$51.35



### B. 3M™ Particulate Respirator 8271, P95





This design helps protect against certain oil and non-oil based particles. It features a collapse-resistant shell for increased durability in most hot, humid conditions.

*Potential Applications: Grinding, sanding, sweeping, machining and other dust producing/oily operations.*

SKU	Description	UOM	Price
3M8271	Particulate respirator 8271, P95	10/BX	\$39.89



\* 3M recommended for relief against nuisance level acid gas or organic vapors. Nuisance levels are less than OSHA PEL or applicable government occupational exposure limits, whichever is lower.

 <p><b>M-Noseclip</b> Proprietary noseclip adjusts easily for fewer pressure points and greater comfort.</p>	 <p><b>Cake-Resistant Filter Media</b> Proprietary filter media with specifically designed filter layers for welding applications provide longer respirator life and easier breathing.</p>	 <p><b>Adjustable Buckle Straps</b> A single tug helps provide a comfortable, secure seal.</p>	 <p><b>Welding Web</b> Unique filter media incorporating protective layers designed to be flame resistant as demonstrated per ASTM D2859-96. (Not a substitute for a faceshield.)</p>	 <p><b>Carbon Filter Material</b> Carbon Filter Media provides relief against odors, vapors, and other gaseous contaminants for greater wearer comfort. For nuisance level relief only.**</p>
---	---	---	---	--



### C. NX95 Particulate Respirator

Class N95 particulate respirator with two latex free straps, adjustable aluminum nose piece and polyethylene nose pad. NIOSH approved.

SKU	Description	UOM	Price
MSGNX95	NX95 Particulate respirator, 20/box	BX	\$9.46
MSGNX95V	NX95 Particulate respirator valved, 10/box	BX	\$8.46



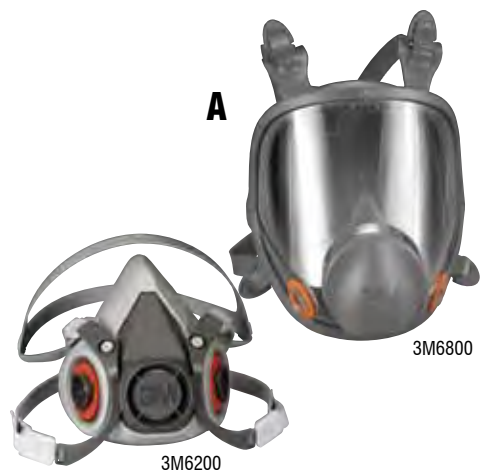

### A. 3M™ Half/Full Facepiece Respirators 6000 Series & Accessories

The 3M™ Half and Full Facepiece Respirators 6000 Series help provide versatility, comfort and ease of use. The low-maintenance design minimizes time required to maintain the product. Just clean as directed between uses and reduce the need for expensive repair programs.

SKU	Description	Size	UOM	Price
3M6100	Half Facepiece	S	EA	\$12.55
3M6200	Half Facepiece	M	EA	\$12.55
3M6300	Half Facepiece	L	EA	\$12.55
3M6700	Full Facepiece	S	EA	\$143.82
3M6800	Full Facepiece	M	EA	\$143.82
3M6900	Full Facepiece	L	EA	\$165.78
3M6885	Faceshield Cover		100/CS	\$177.04

### B. 3M™ Cartridges

NIOSH approved cartridges and filter to be used with 3M Half and Full Facepiece Respirator 6000 Series, Half Facepiece Respirator 7500 Series, Full Facepiece Respirator Series 7800 and Full Facepiece Respirator FF-400 Series. Some filters may require a retainer or adapter.

SKU	Description	UOM	Price
3M2071	Particulate Filter, P95	PR	\$4.29
3M2078	Particulate Filter, P95 w/ Nuisance Organic Vapor/Acid Gas Relief**	PR	\$7.64
3M2091	Particulate Filter, P100	PR	\$6.88
3M2097	Particulate Filter, P100 w/ Nuisance Organic Vapor Relief***	PR	\$9.43
3M2291	Advanced Particulate Filter P100	PR	\$7.61
3M7093	N95 Particulate Filter, P100 (For use with 5000, 6000, 7000 Series Face pieces with bayonet Attachments)	12/PK	\$52.97
3M5N11	Particulate Filter, N95 for 5000, 6000 and 7000 Series Facepieces (Requires Retainer Adapter)	10/BX	\$15.67
3M5P71	Particulate Filter, P95 for 5000, 6000 and 7000 Series Facepieces (Requires Retainer Adapter)	10/BX	\$18.55
3M501	Retainer 5000/6000/7000 Series	10 PR/BX	\$42.07
3M6001	Organic Vapor Cartridge	PR	\$11.70
3M6002	Acid Gas Cartridge	PR	\$12.66
3M6003	Organic Vapor/Acid Gas Cartridge	PR	\$12.35
3M6004	Ammonia Methylamine Cartridge	PR	\$13.96
3M6005	Formaldehyde/Organic Vapor Cartridge	PR	\$14.11
3M6006	Multi Gas/Vapor Cartridge	PR	\$12.53
3M6009	Mercury vapor or Chlorine Cartridge	PR	\$27.98
3M60923	Cartridge/Filter Organic Vapor/Acid Gas/P100	PR	\$23.44
3M60926	Cartridge/Filter Multigas/Vapor/P100	PR	\$25.41
3M60921	Cartridge/Filter Organic Vapor/P100	PR	\$23.38



B

3M6003



3M6004

\*3M recommended for relief against nuisance levels of acid gases. Nuisance level refers to concentrations not exceeding OSHA PEL or other applicable government occupational exposure limits, whichever is lower.

\*\*3M recommended for relief against nuisance levels of acid gases and for ozone protection up to 10X OSHA PEL. Not NIOSH certified for use against ozone. Nuisance level refers to concentrations not exceeding OSHA PEL or other applicable government occupational exposure limits, whichever is lower.

\*\*\*3M recommended for relief against nuisance levels organic vapors and ozone protection up to 10 times OSHA PEL. Not NIOSH certified for use against ozone. Nuisance level refers to concentrations not exceeding OSHA PEL or other applicable government occupational exposure limits, whichever is lower.

#### WARNING!



These respirators help reduce exposure to certain airborne contaminants. Before use, the wearer must read and understand the USER Instructions provided as a part of the product packaging. A written respiratory protection program must be implemented meeting all the requirements of OSHA 1910.134 including training, fit testing and medical evaluation. In Canada, CSA standards Z94.4 requirements must be met and/or requirements of the applicable jurisdiction, as appropriate. Misuse may result in sickness or death. For proper use, see packaging instructions, supervisor, or call 3M OH&ESD Technical Service in USA at 1-800-243-4630 and in Canada at 1-800-267-4414.





**A. 3M™ Full Facepiece 7800S, Half Facepiece 7500 Respirators & Accessories**

These silicone facepieces enhance comfort and improve durability. Breathing is easier with the extra-large inhalation and exhalation valves. Double-flange face seal and six adjustable straps on the 7800's help provide a secure fit. Not for use with 3M™ Self-Contained Breathing Apparatus (SCBA) Systems.

SKU	Description	Size	UOM	Price
3M7800S(sm)	Full Facepiece 7800S-S	S	EA	\$394.70
3M7800S(MD)	Full Facepiece 7800S-M	M	EA	\$394.70
3M7800S(lg)	Full Facepiece 7800S-L	L	EA	\$394.70
3M7501	Half Facepiece 7501	S	EA	\$28.82
3M7502	Half Facepiece 7502	M	EA	\$28.82
3M7503	Half Facepiece 7503	L	EA	\$28.70
3M7093	Particulate Filter P100		12/PK	\$52.97
3M7882	Nosecup Valve Assembly, 7800S		2/PK	\$10.72
3M7884	Replacement 7800 Lens		EA	\$79.84
3MSA2000	Dual Airline Back-Mounted Adapter Kit		EA	\$322.46



**B. 3M™ Ultimate FX Full Facepiece Respirator, FF-400 Series**

Engineered for maximum comfort, durability and visibility, the Ultimate FX FF-400 is the only respirator with Scotchgard™ Protector vision on the lens. Offered in three sizes, it features soft yet durable silicone material and a large lens for superior peripheral.

SKU	Description	Size	UOM	Price
3MFF-401	Ultimate FX Full Facepiece Respirator	S	EA	\$224.36
3MFF-402	Ultimate FX Full Facepiece Respirator	M	EA	\$224.36
3MFF-403	Ultimate FX Full Facepiece Respirator	L	EA	\$224.36

**C. 3M™ Dual Cartridge Respirator Assembly 5XP71, Organic Vapor/P95**

The 3M Dual Cartridge Respirator Assembly 5XP71, Organic Vapor/P95, respirator is NIOSH approved for protection against certain organic vapors and oil and non-oil based particles associated with paint spray and pesticide applications. Maintenance free. Cartridges cannot be replaced.

SKU	Description	Size	UOM	Price
3M51P71	Dual Cartridge Respirator Assembly Organic Vapor/P95	S	EA	\$22.19
3M52P71	Dual Cartridge Respirator Assembly Organic Vapor/P95	M	EA	\$22.19
3M53P71	Dual Cartridge Respirator Assembly Organic Vapor/P95	L	EA	\$22.19



**D. 3M™ Organic Vapor/Acid Gas Respirator Assembly 5X03**

Gas and Vapor Respirator 5000 Series offer workers greater convenience. They're pre-assembled, so there are no spare parts to replace. The cradle suspension holds the respirator in place with minimal pressure to the back of the worker's neck and the bridge of the nose. Also features a low-profile facepiece/cartridge for a wider field of vision and greater comfort while wearing glasses or goggles. The respirators are color coded by size and are NIOSH approved. Replaceable prefilters eliminate the need to replace the entire respirator. Maintenance free. Cartridges cannot be replaced.

SKU	Description	Size	UOM	Price
3M5103	Organic Vapor/Acid Gas Respirator Assembly	S	EA	\$18.09
3M5203	Organic Vapor/Acid Gas Respirator Assembly	M	EA	\$18.09
3M5303	Organic Vapor/Acid Gas Respirator Assembly	L	EA	\$18.09

**WARNING!**



These respirators help reduce exposure to certain airborne contaminants. Before use, the wearer must read and understand the USER Instructions provided as a part of the product packaging. A written respiratory protection program must be implemented meeting all the requirements of OSHA 1910.134 including training, fit testing and medical evaluation. In Canada, CSA standards Z94.4 requirements must be met and/or requirements of the applicable jurisdiction, as appropriate. Misuse may result in sickness or death. For proper use, see packaging instructions, supervisor, or call 3M OH&ESD Technical Service in USA at 1-800-243-4630 and in Canada at 1-800-267-4414.



# Respiratory

## Half/Full Face



by Honeywell



### A. North® 7700 Series Silicone Half Mask Respirator & Accessories

The 7700's soft non-allergenic silicone seal provides excellent protection, comfort and fit. The half mask cradle suspension system allows the facepiece to seal evenly on the face without creating pressure points. Its low profile gives workers a wide field of vision and does not interfere with protective eyewear. The low inhalation and exhalation resistance of the 7700 Series makes breathing easier to reduce worker fatigue. NIOSH approved when used with North cartridges and/or filters. Cartridges and filters sold separately.

SKU	Description	Size	UOM	Price
NORR7700-30S	7700 Series half mask	S	EA	\$28.77
NORR7700-30M	7700 Series half mask	M	EA	\$28.77
NORR7700-30L	7700 Series half mask	L	EA	\$28.77
NORR7500-1B	Cartridge filter organic vapors		PR	\$12.15
NORR7500-2B	Cartridge acid gas/formaldehyde		PR	\$12.64
NORR7500-3B	Cartridge organic vapor, acid gas		PR	\$12.38
NORR7580P100	P100 Particulate Filter		PR	\$8.67
NORR75SCP100	Multi-Purpose Cartridge & P100 Filter		PR	\$24.08
NORR7583P100	OV, Acid Gas Cartridge & P100 Filter		PR	\$23.61

### B. North® 5500 Series Half Mask

Elastomeric half mask is the economical solution that does not skimp on features. A wide contoured sealing area provides great fit. The low "dead air" space limits re-breathing of exhaled air for increase comfort and worker productivity. Latex free straps stretch and move with the worker while providing optimum support NIOSH approved when used with North cartridges and/or filters. Cartridges and filters sold separately.

SKU	Description	Size	UOM	Price
NORR5500-30S	5500 Series Half Mask	S	EA	\$14.01
NORR5500-30M	5500 Series Half Mask	M	EA	\$14.01
NORR5500-30L	5500 Series Half Mask	L	EA	\$14.01



### C. Advantage® 200 Respirators

The Advantage 200 Respirator is unlike any other half-mask respirator you'll find. Offering unmatched fit and comfort, it's the first respirator to feature MSA's patented MultiFlex® System, a soft, pliable combination of rubber and plastic that provides a customized fit. The result is a respirator that feels great on any face, because it works to remove the pressure points from the face seal area. This design results in an effective sealing surface that instantly conforms to the wearer's unique facial characteristics. Advantage cartridges are compatible with 42 CFR 84 NIOSH-approved.

SKU	Description	Material	Color	Size	UOM	Price
MSA815696	With 2-piece neckstrap	Thermoplastic rubber	Grey	S	EA	\$17.25
MSA815692	With 2-piece neckstrap	Thermoplastic rubber	Grey	M	EA	\$17.25
MSA815700	With 2-piece neckstrap	Thermoplastic rubber	Grey	L	EA	\$17.25
MSA815448	With single neckstrap	Thermoplastic rubber	Clear blue	S	EA	\$16.72
MSA815444	With single neckstrap	Thermoplastic rubber	Clear blue	M	EA	\$16.72
MSA815452	With single neckstrap	Thermoplastic rubber	Clear blue	L	EA	\$16.72

### D. Advantage® Respirator Cartridges

The complete line of Advantage Cartridges protect against a wide variety of contaminants. Filter cartridges protect against dusts, particles and mists. Chemical Cartridges protect against gases and vapors. Combination cartridges deliver protection from both particulate and gaseous contaminants. All cartridges, multigas w/ P100 are interchangeable between all Advantage Respirators and are color-coded to indicate the type of protection offered. The Complete Advantage line of particulate, chemical and combination cartridges are approved under 42 CFR Part 84.

SKU	Description	UOM	Price
MSA818342	Flexi-Filter P100	PR	\$9.38
MSA815366	GME-P100 super cartridge	PR	\$28.26

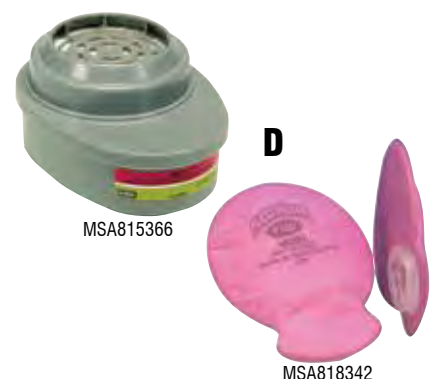



## 3M™ Versaflo™ TR-300 Powered Air Purifying Respirators

The lightweight 3M™ Versaflo™ TR-300 Powered Air Purifying Respirator is the key to easy-to-use, versatile respirator systems for particulate environments. With its compact, well-balanced and slim design, the Versaflo TR-300 powered air respirator is the answer to respiratory protection needs for many users. The TR-300 is available with a flexible range of headgear — from lightweight hoods to industrial helmets that can provide head, eye and face protection.

### A. 3M™ Versaflo™ PAPR Unit TR-302N

The TR-300 PAPR is a light weight, easy-to-use PAPR for protection against particulates and certain nuisance odors. The TR-302N PAPR Unit does not include a filter, belt, battery, or charger.

SKU	Description	UOM	Price
3MTR302N	3M™ Versaflo™) PAPR Unit TR-302N	EA	\$493.87



### B. 3M™ Versaflo™ PAPR Assembly TR-305N

The TR-300 PAPR is a light weight, easy-to-use PAPR for protection against particulates and certain nuisance odors. The TR-305N assembly includes a standard belt, economy battery, HE filter, and single-station charger.

SKU	Description	UOM	Price
3MTR305N	Versaflo™ PAPR Assembly TR-305N, Standard Belt and Economy Battery	EA	\$988.76

### C. 3M™ Versaflo™ PAPR Assembly TR-306N

The TR-300 PAPR is a light weight, easy-to-use PAPR for protection against particulates and certain nuisance odors. The TR-306N assembly includes a high durability belt, high capacity battery, HE filter, and single-station charger.

SKU	Description	UOM	Price
3MTR306N	Versaflo™ PAPR Assembly TR-306N, High Durability Belt and High Capacity Battery	EA	\$1109.95



### D. 3M™ Versaflo™ PAPR Assembly TR-307N

The TR-300 PAPR is a light weight, easy-to-use PAPR for protection against particulates and certain nuisance odors. The TR-307N assembly includes an easy clean belt, high capacity battery, HE filter, and single-station charger.

SKU	Description	UOM	Price
3MTR307N	Versaflo™ PAPR Assembly TR-307N, Easy Clean Belt and High Capacity Battery	EA	\$1109.95

**WARNING!**

These respirators help reduce exposure to certain airborne contaminants. Before use, the wearer must read and understand the USER Instructions provided as a part of the product packaging. A written respiratory protection program must be implemented meeting all the requirements of OSHA 1910.134 including training, fit testing and medical evaluation. In Canada, CSA standards Z94.4 requirements must be met and/or requirements of the applicable jurisdiction, as appropriate. Misuse may result in sickness or death. For proper use, see packaging instructions, supervisor, or call 3M OH&ESD Technical Service in USA at 1-800-243-4630 and in Canada at 1-800-267-4414.





### 3M™ GVP-Series Powered Air Purifying Respirators

These assemblies are available with a web belt or comfort belt. In addition to the waist belt, the assembly includes power cord, motor blower, battery, charger and flow meter. The system contours to the hip and body for comfort.

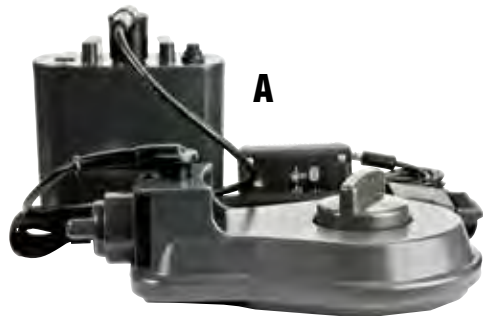

#### A. 3M™ GVP-Series PAPR GVP-1

This belt-mounted powered air purifying respirator assembly includes components needed to make a complete PAPR system. Helps provide respiratory protection when combined with 3M™ Headgear and breathing tube.

SKU	Description	UOM	Price
3MGVP-1	GVP-Series PAPR, Standard Belt, NiCd Battery	EA	\$943.00

#### B. 3M™ GVP-Series PAPR GVP-CB

This belt-mounted powered air purifying respirator assembly includes components needed to make a complete, comfortable PAPR system. Offers high airflow to the worker. Comfort belt is adjustable to fit waists from 26 inches to 54 inches.

SKU	Description	UOM	Price
3MGVP-CB	GVP-Series PAPR, Comfort Belt, NiCd Battery	EA	\$1096.47



#### C. 3M™ Cartridges and Filters GVP-Series

SKU	Description	UOM	Price
3MGVP-402	Acid Gas Cartridge	6/PK	\$372.36
3MGVP-440	HEPA Filter	8/PK	\$326.70
3MGVP-443	Organic vapor/Acid Gas/HEPA Cartridge	6/PK	\$562.40

#### D. 3M™ Vortex Cooling Assembly V-100

This supplied air respirator assembly, when used with approved breathing tube and headgear, can help regulate the flow and temperature of supplied air system. Cools the air up to 50°F (28°C). Includes the cooling tube, waist belt and holder.

SKU	Description	UOM	Price
3MV-100	Vortex Cooling Assembly	EA	\$407.19



#### E. 3M™ Air Supply Hoses

Choose the type and length that best fits your needs. Also available in 25' and 100' lengths. Industrial interchange fittings.

SKU	Description	Length	UOM	Price
3MW9435-50	3/8" High Pressure	50'	EA	\$212.90

**IMPORTANT:** All 3M™ products shown in this catalogue must be used in accordance with the OSHA regulations and the user instructions, warnings, and limitations accompanying each product.



**A. 3M™ Versaflo™ Hood Assembly S-757**

Similar to S-657 but with a fabric specifically intended to help capture paint overspray, minimizing the potential for paint to flake off the wearer and onto the work piece. Fabric has an internal film barrier to help prevent paint contact with skin or clothes.

SKU	Description	UOM	Price
3MS-757	Versaflo™ Hood Assembly S-757	EA	\$86.65



**B. 3M™ Versaflo™ Hood Assembly S-655**

Head, face, neck and shoulder coverage. Its respiratory seal is a comfortable, knitted inner collar that is shorter and thinner than previous models. General purpose, cost-effective fabric.

SKU	Description	UOM	Price
3MS-655	Versaflo™ Hood Assembly S-655	EA	\$79.58

**C. M-300 Respiratory Hard Hat**

Provides respiratory (OSHA APF 25) protection, plus limited head (ANSI Z89.1-2003 Type 1 Class G) and eye (ANSI Z87.1-2010) protection. 6-strap textile suspension offers maximum comfort. Recommended for most powder handling, paint spraying and general maintenance applications where hard hat protection is required or desired. Weighs approx. 850g (1.9 lbs)\*

SKU	Description	UOM	Price
3MM305	Respiratory Hard Hat Assembly, Standard Visor, Face Seal	EA	\$409.53
3MM307	Respiratory Hard Hat Assembly, Premium Visor, Flame Resistant Face Seal	EA	\$426.55



**D. M-400 Respiratory Helmet**

Provides respiratory (OSHA APF 1000) protection, plus limited head (ANSI Z89.1-2003 Type 1 Class G) and eye (ANSI Z87.1-2010) protection. 6-strap textile suspension offers maximum comfort. Recommended for most powder handling, paint spraying, and general maintenance applications where the highest level of respiratory protection defined by OSHA and hard hat protection is required or desired. Weighs approx. 1049g (2.3 lbs)\*

SKU	Description	UOM	Price
3MM405	Respiratory Helmet Assembly, Standard Visor, Shroud	EA	\$564.15
3MM407	Respiratory Helmet Assembly, Premium Visor, Flame Resistant Shroud	EA	\$628.91

\* Weight is complete assembly.

**WARNING!**

These respirators help reduce exposure to certain airborne contaminants. Before use, the wearer must read and understand the USER Instructions provided as a part of the product packaging. A written respiratory protection program must be implemented meeting all the requirements of OSHA 1910.134 including training, fit testing and medical evaluation. In Canada, CSA standards Z94.4 requirements must be met and/or requirements of the applicable jurisdiction, as appropriate. Misuse may result in sickness or death. For proper use, see packaging instructions, supervisor, or call 3M OH&ESD Technical Service in USA at 1-800-243-4630 and in Canada at 1-800-267-4414.





**A**

### A. PA30IS (Intrinsically Safe) Powered Air-Purifying Respirator

The PA30IS helps provide respiratory protection to workers in many potentially explosive atmospheres. Vapors from organic solvents and high dust concentrations can be triggered from a spark by equipment. The intrinsically safe PA30IS Powered Air-Purifying Respirator is designed exactly for these types of environments.

SKU	Description	UOM	Price
BULPA30ISTIC	PA30IS PAPR w/decon belt complete	EA	\$1578.72

### B. EVA Powered Air Purifying Respirator

EVA is the latest in cutting-edge Powered Air-Purifying Respirator (PAPR) technology and design. EVA offers users an easy-to-read visual fuel gauge, Active Flow Technology that automatically responds to a worker's need for more or less air flow, two distinct audible alarms for low battery and low air flow, a long-lasting 10,000 hour brushless motor, and a single combination filter for easy use.

SKU	Description	UOM	Price
BULEVA20TIC	EVA Blower, Battery, Charger, Breathing Tube, 20TIC Hood	EA	\$1241.22
BULPAPRFC3	Filter, HEPA, EVA (6 pack)	PK	\$257.14



**B**



**C**

### C. 88VX Series Respirator for Abrasive Blasting

The Bullard 88VX Series airline respirators offer comfortable, reliable respiratory protection for abrasive blasters and painters. NIOSH approved as a Type C or CE Continuous Flow Class Respirator (Approval No. TC-19C-293) Bullard's lightweight inner shell with an adjustable headband suspension holds the respirator firmly and comfortably on the wearer's head. Air-flow is channeled directly to the user's breathing zone for easy breathing. The helmet easily accommodates beards, prescription eye wear or safety glasses. No fit testing is required.

SKU	Description	UOM	Price
BUL88VX3230H	88VX series respirator for abrasive blasting includes air supply hose	EA	\$762.40
BUL88VXAK	Window frame maintenance kit	KT	\$58.62
BUL88VXBT	Breathing tube	EA	\$76.99
BUL88VXRTP	Ratchet suspension and air plenum	EA	\$32.33



## A. Sperian Survivair Cougar™ 30 minute SCBA

The Cougar meets the demands of industrial users who want the finest respiratory protection against environments that are immediately dangerous to life or health (IDLH), but do not require the performance of an NFPA-compliant SCBA. The Cougar design eliminates unnecessary fire fighting features, keeping costs under control for today's dollar-conscious industrial users, yet providing maximum safety and comfort. Standard configuration includes a TwentyTwenty Plus medium facepiece and a 2216 psig, aluminum cylinder without locking collar.

SKU	Description	UOM	Price
SVR888888	30-minute Cougar	EA	\$1872.43



## B. North® CBRN 30 minute Escape Hood

NIOSH CAP 2 Escape hood offers minimum of 30 minutes escape from many contaminants. Dual cartridge design is ergonomically balanced for increased comfort. Features anti-claustrophobic clear hood and contoured butyl neck dam for easy donning and better fit.

SKU	Description	UOM	Price
NORER2000CB	CBRN 30 minute Escape Hood	EA	\$264.76

## C. North® 7900 Series Emergency Escape Mouthbit Respirators

The 7900 Series Emergency Escape Mouthbit Respirators consists of a single cartridge, mouthpiece, neck strap, and nose clip attached to the cartridge body by a braided cord. These Respirators are designed for escape only from contaminants listed on the respective labels. They are not approved for entry or continuous use, or for escape from atmospheres that are Immediately Dangerous to Life and Health (IDLH), including atmospheres with less than 19.5% oxygen. Once the North 7900 Series Mouthbit Respirator has been used for escape from a contaminated atmosphere it must be discarded in accordance with EPA and local regulations.

SKU	Description	UOM	Price
NORR7902	Emergency Escape Mouthbit Respirator Acid Gas	EA	\$18.47
NORR7904	Emergency Escape Mouthbit Respirator Ammonia	EA	\$21.38





**A**

### A. Spray Socks

Provides comfortable protection against overspray and other particulates. Spray Sock fits over the head and can be worn with goggles, half mask or full mask respirators. The stretch knit material is breathable and cool to wear. One size fits all.

SKU	Description	UOM	Price
ALLE1410-12	Spray socks	12/PK	\$13.95

### B. Respirator Cleaning Pads

Large (5" x 8"), individually foil-packaged towelettes contain 70% Isopropanol and are designed specifically for rubber respirator facepieces and other personal safety equipment. The box is designed as a wall mounted dispenser, or can be wall mounted using the box holder. 100 towelettes per box. Or choose alcohol free cleaning pads where the manufacturer recommends using a non-alcohol cleaning wipe. Active ingredient: Benzalkonium Chloride. Will not harm even the most sensitive rubber facepieces. 100 towelettes per box.

SKU	Description	UOM	Price
ALLE1001	Respirator cleaning pads	100/BX	\$12.63
ALLE3001	Alcohol free cleaning pads	100/BX	\$12.63



**B**

**C**



### C. The Big Ones

Individually foil-packaged towelettes contain 70% isopropanol and are designed specifically for rubber respirator facepieces and other personal safety equipment. These extra large 8" x 11" towelettes are perfect for big cleaning jobs such as full face and supplied air respirators. 50 per box. Available in alcohol free.

SKU	Description	UOM	Price
ALLE1001-05	Big Ones alcohol pads	50/BX	\$9.39
ALLE3001-05	Big Ones alcohol free pads	50/BX	\$9.39

### D. Respirator Cleaning Kit

Convenient cleaning and storage for full face and half mask respirators. Contains ninety 1/2 oz. packets of water-soluble cleaner, air bulb, bucket, brush, 100 each sterile storage bags and seals, and large 17 quart, two sided bucket. Kit meets OSHA recommendations.

SKU	Description	UOM	Price
ALLE4001	Respirator cleaning kit	EA	\$121.05
ALLE4001-02	Dry replacement soap	EA	\$61.40
ALLE4001-05	Disposable storage bags	100/BX	\$21.49



**D**



**A. 3M™ Respirator Cleaning Wipe 504, Alcohol-Free, Individually Packaged**

These wipes are used to clean 3M™ Elastomeric Facepiece Respirators. The 8" x 10" tow-elettes are alcohol free and will not damage the facepiece materials.

SKU	Description	UOM	Price
3M504	Respirator Cleaning Wipes 504	100/BX	\$49.88



**B. 3M™ FIT Test Kits and Accessories**

Fit testing materials can help you meet OSHA requirements. Equipment and procedures provide a simple, direct way to meet OSHA qualitative fit testing requirements. Our fit test products can be used with any particulate or gas/vapor respirator with a particulate prefilter to test face-to-respirator seal. The equipment helps satisfy respiratory program requirements and is easy to use during respiratory training. Fit test kits include: hood & collar assembly, sensitivity solution, fit test solution, two nebulizers, english/spanish instruction book.

SKU	Description	UOM	Price
3MFT-30	Bitter solution fit test kit	EA	\$289.89

**IMPORTANT:** All 3M™ products shown in this catalogue must be used in accordance with the OSHA regulations and the user instructions, warnings, and limitations accompanying each product.

**C. OHD Quantifit™**

Introducing the OHD Quantifit...the new gold standard in respirator fit testing. We've taken the strengths of the OHD FitTester 3000, and made it even better. The new design includes fast 1-3 minute respirator fit tests, on-board storage, keyboard input, USB printer connection, USB memory stick port, and a simpler user interface. It's smaller, lighter and quieter. This advanced system is based on a patented technology called Controlled Negative Pressure (CNP), which directly measures leakage at the face-to-facepiece seal. There are no challenge agents to spray, breathe, mix, fill, or spill, so you can perform your testing quickly and easily. With the Quantifit, you'll be confident that your employees are wearing respirators that actually fit. Upgrade your respirator program with the fastest and most accurate method available. The best just got better!

SKU	Description	UOM	Price
OHD9519-4000	OHD Quantifit	EA	\$12265.91



**D**



**D. WorkSmart® Half-Mask Respirator Bag**

Rugged nylon bag provides instant access to half-mask respirator or small tools. Lightweight, durable nylon construction protects equipment from dust and moisture. Hook and loop closure for fast seal and release. Webbing belt loop closes with hook and loop for easy donning, doffing, and tear-away. Water-resistant, 7" x 6" x 3.5" main hold.

SKU	Description	Capacity	Color	UOM	Price
ERG13180	Half-mask respirator bag	145 ci	Black	EA	\$7.73







# Hearing Protection

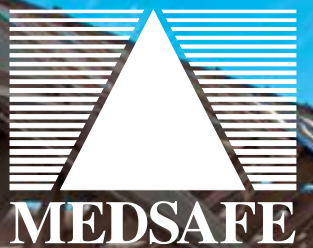

**A. Max® Earplugs**

Workers who need to block out loud noise demand the best protection and comfort available in an earplug. That's where Max comes in. The world's most-used polyurethane earplug, Max offers superior noise-blocking performance in a single-use earplug. Max's new enhanced contoured shape is easier to insert and resists backing out of the ear canal, while its softer foam delivers superior long-wearing comfort – delivering solid performance that your workers can depend on. NRR 33. Tested in accordance with ANSI S3.19-1974. Coral color.

SKU	Description	Type	Package	UOM	Price
HOWMAX1	Max	Uncorded	Polybag	200 PR/BX	\$26.21
HOWMAX30	Max	Corded	Polybag	100 PR/BX	\$24.80
HOWMAX30USA	RWB earplugs	Corded	Polybag	100 PR/BX	\$26.13

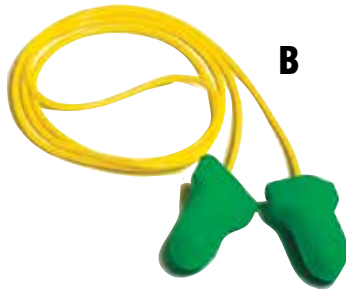
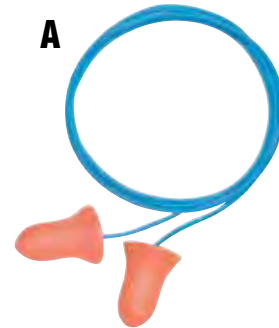

**B. Max Lite® Earplugs**

Ideal for workers with smaller ear canals, Max Lite's low-pressure foam expands gently inside the ear canal for comfortable long-term wear, eliminating that feeling of "tightness." Its contoured T-shape delivers easy handling for insertion and removal. Plus, Max Lite is available with special cording, packaging and dispenser options, ideal for process industries with low tolerances for packaging waste. Attenuation tested in accordance with ANSI S3.19-1974. Green color. NRR 30 dB.

SKU	Description	Type	Package	UOM	Price
HOWLPF1	Max Lite	Uncorded	Polybag	200 PR/BX	\$21.45
HOWLPF30	Max Lite	Corded	Polybag	100 PR/BX	\$21.09

**C. Laser Lite® Earplugs**

The bright idea in hearing protection, Laser Lite's low-pressure foam expands gently inside the ear canal for comfortable long-term wear, while its contoured T-shape delivers easy handling. Its high visibility magenta and yellow colors make compliance checks quick and easy. Plus, Laser Lite is available with special packaging and dispenser options, ideal for process industries with low tolerances for packaging waste. Attenuation tested in accordance with ANSI S3.19-1974. Magenta/Yellow color, NRR 32 dB.

SKU	Description	Type	Package	UOM	Price
HOWLL1	Laser Lite	Uncorded	Polybag	200 PR/BX	\$21.62
HOWLL30	Laser Lite	Corded	Polybag	100 PR/BX	\$20.92

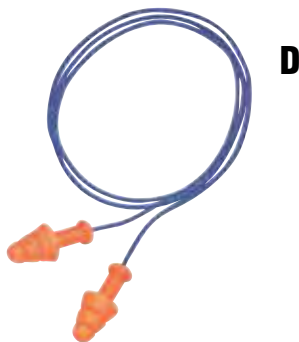
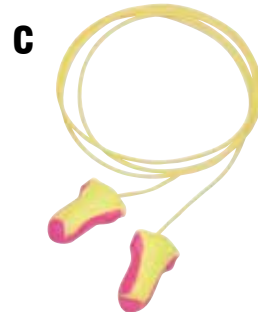

**D. SmartFit® Earplugs**

The only multiple-use earplug with Conforming Material Technology™, SmartFit uses body heat to adapt to the shape of the ear canal for a comfortable, personalized fit. With a detachable cord system, HearPack® carry case and special application styles available, it's the ultra-smart choice for today's diverse workplace. NRR 25.

SKU	Description	Type	Package	UOM	Price
HOWSMF-30	SmartFit reusable earplugs	Detachable cord	HearPack®	PR	\$.81

**E. AirSoft® Reusable Earplugs**

Optimized for exceptional in-ear comfort, AirSoft's new four flange design creates a better seal in the ear canal, delivering optimal protection and increased comfort for long-term wear. Internal fins create an interlocking, noise-blocking barrier within the air pocket, providing dependable attenuation for all wearers upon proper insertion. At the same time, AirSoft's firm stem and tapered shape facilitate easy insertion and removal, and allow the earplug to sit comfortably in the ear canal. NRR 27 dB.

SKU	Description	Type	UOM	Price
HOWDPAS30R	AirSoft, red polycord	Corded	PR	\$1.02
HOWDPAS30W	AirSoft, white nylon cord	Corded	PR	\$1.02

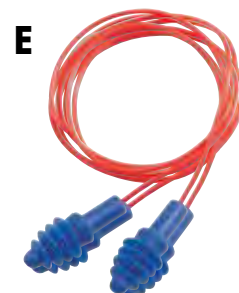

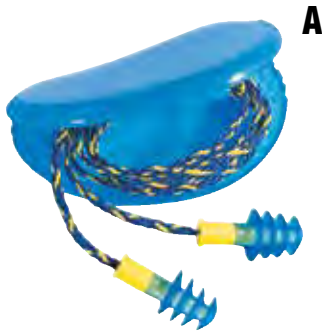

### A. Fusion® Earplugs

Fusion reusable earplugs use advanced manufacturing technology to deliver a revolutionary combination of all-day comfort and easy handling. FlexiFirm® core ensures easy insertion into the ear canal and a superior fit all day long. Fusion's patented SoftFlange™ design adjusts perfectly to the ear canal to deliver unmatched comfort and superior attenuation. Two sizes – regular and small – provide optimal fit for comfort and safety, while its soft braided fabric detachable cord system adapts to any application. Packaged in the HearPack® storage case for long-term use. NRR 27 dB.

SKU	Description	Type	Package	UOM	Price
HOWFUS30-HP	Fusion regular	Detachable cord	HearPack®	PR	\$1.10
HOWFUS30S-HP	Fusion small	Detachable cord	HearPack®	PR	\$1.10

### B. Leight® Source 500 Earplug Dispenser

Leight Source 500 provides a highly visible, user-friendly, permanent hearing protection center. Built with heavy-duty anodized aluminum and designed for wall installation, Leight Source 500 dispenses earplugs with a simple turn of the handle, providing a hygienic and economical source for earplugs. Leight Source 500 is ideal for large factories and process industries that have zero tolerance for packaging waste. Holds 500 pairs of Howard Leight earplugs only, including Max®, Max Lite® and Laser Lite®.

SKU	Description	NRR	UOM	Price
HOWLS500	Leight Source 500 earplug dispenser		EA	\$146.21
HOWMAX1D	Max earplugs refill	33 dB	500 PR/BX	\$59.07
HOWLL1D	Laser Lite earplugs refill	32 dB	500 PR/BX	\$51.39
HOWLRF1D	Max Lite earplugs refill	30 dB	500 PR/BX	\$51.39

B



C

### C. Leight® Source 400 Earplug Dispenser

The Leight Source 400 earplug dispenser offers easy access to single-use earplugs in any job-site. As a tabletop or wall-mount dispenser, Leight Source 400 provides a user-friendly source for earplugs - simply twist the spout to release earplugs! Place Leight Source 400 by the shop door or in the lunchroom, and workers can access a new pair of earplugs as they enter the workspace. Plus, it clearly displays fitting instructions for roll-down and no-roll foam earplugs to demonstrate proper insertion. Holds 400 pairs of Howard Leight single-use earplugs.

SKU	Description	NRR	UOM	Price
HOWLS-400	Leight Source 400 earplug dispenser		EA	\$22.06
HOWLL-LS4	Laser Lite earplugs refill	32 dB	200 PR/BX	\$19.53

### D. Quiet® Banded Earplugs

Designed for people who are exposed to intermittent noise, Quiet Bands offers superior protection. Smooth, ergonomic pods fit inside the ear canal for maximum protection, while its patented band design prevents ear pods from touching dirty or contaminated surfaces when set down. Quiet Bands can be worn in multiple positions. Includes extra pair of replacement ear pods.

SKU	Description	NRR	UOM	Price
HOWQB1HYG	QB1HYG banded inner-aural w/replacement pods	27	EA	\$4.16
HOWQB2HYG	QB2HYG banded supra-aural w/replacement pods	25	EA	\$4.16
HOWQB100HYG	QB1HYG replacement pods		PR	\$2.03
HOWQB200HYG	QB2HYG replacement pods		PR	\$2.03

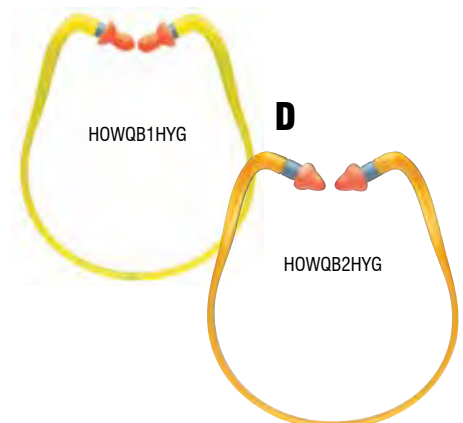

D





### A. 3M™ E-A-R™ UltraFit™ Earplugs

The triple flange design helps seal out noise comfortably. Earplugs are washable and reusable, making them an economical choice. Advance polymer material gives maximum comfort and durability, so you get the most out of every wear. NRR\* 25 dB.

SKU	Description	Type	UOM	Price
CAB340-4001	UltraFit w/ carrying case	Uncorded	PR	\$1.16
CAB340-4002	UltraFit w/ carrying case	Corded	PR	\$1.51
CAB340-4003	UltraFit	Uncorded	PR	\$.91
CAB340-4004	UltraFit	Corded	PR	\$1.25
CAB340-6004	UltraFit Plus NRR* 26 dB	Corded	PR	\$1.73

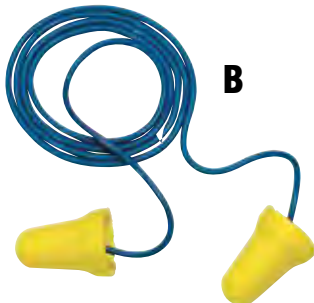
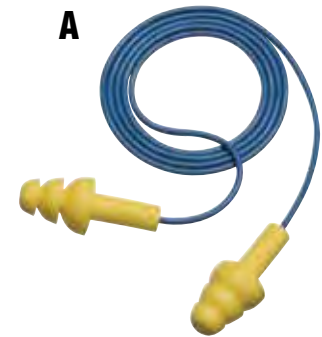

### B. 3M™ E-A-R™ E-Z Fit™ Earplugs

The E-Z Fit line of earplugs was designed specifically for smaller ear canals, providing comfort and a secure fit. The self-adjusting foam and bell shape allow for easy insertion and help to keep the earplug from shifting or dislodging. NRR\* 28 dB.

SKU	Description	Type	UOM	Price
CAB312-1222	E-Z Fit	Corded	200 PR/BX	\$65.31

### C. 3M™ E-A-R™ Push-Ins™ Earplugs

An innovative, simple-to-use design and the ultra-soft performance of a tip made of patented EARform™ foam. The EARform foam expands in the ear canal to create a comfortable seal against noise. The unique foam softens and becomes more pliable with body temperature for improved seal and comfort. The plugs stay seated with a gentle low pressure seal on the ear canal. NRR\* of 28 dB.

SKU	Description	Type	UOM	Price
CAB318-1003	Push-Ins	Corded	200 PR/BX	\$108.43

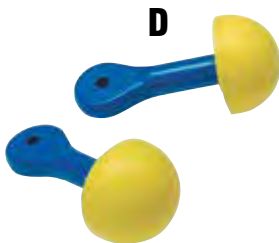

### D. 3M™ E-A-R™ Express™ Pod Plugs™

These reusable earpods feature the InstaSeal system, which combines a unique pod shape with a soft grip. The grip design eliminates the need to touch the plug's pod which in turn reduces the chance of contamination. The soft foam pods have a slow recovery time offering a customized and secure fit every time. Designed to not shift or dislodge with jaw movement. NRR\* 25 dB.

SKU	Description	Type	Package	UOM	Price
CAB311-1115	Express pod plugs	Corded	Assorted	100 PR/BX	\$90.43

### E. 3M™ E-A-R™ Push-Ins™ SoftTouch™ Earplugs

Provides the highest NRR of all Push-Ins Earplugs—31\*dB. Made of specially formulated foam for added softness. A gentle push is all it takes to insert. Flexible, pistol-grip handle and stem allow fingertip control for easy insertion. Eliminates dirt transfer for better hygiene. CSA Class AL.

SKU	Description	Type	UOM	Price
CAB318-4001	Push-Ins SoftTouch Earplugs	Corded	200/BX	\$111.85



\*Research suggests that many users will receive less noise reduction than indicated by the NRR due to variation in earplug fit and wearing time. It is recommended that the NRR be reduced by 50% for estimating the average amount of noise reduction provided. Hearing warning can be found page 246.





### A. 3M™ E-A-R™ ARC Plug™ Earplugs in Carrying Case

Patented Hear-Through™ design allow workers to hear conversations, signals, or other critical sounds clearly, while protecting against damaging impulse noise from an arc flash. Insert the yellow end and it allows clear hearing. Arc blast is instantly suppressed by a calibrated filter, reducing it to a safer level. Filter reacts instantaneously to reduce or eliminate the risk of hearing damage or concussive disorientation. Insert red end for steady-state 22dB protection from high-noise levels (heavy equipment, etc. ) Washable and reusable plugs include a plastic carrying case with dielectric chain. Red end NRR\* 22dB; Yellow end NRR\* 0dB (level dependent); CSA Class AL.

SKU	Description	UOM	Price
CAB370-2000	ARC Plug Earplugs in carrying case	PR	\$13.80

### B. 3M™ E-A-R™ Classic™ Earplugs

E-A-R Classic Plugs are the most popular earplugs in the world. The moisture-resistant foam is non-irritating and its slow recovery provides comfort with low pressure. NRR\* 29 dB and 33 dB.

SKU	Description	Type	Package	NRR*	UOM	Price
CAB310-1001	Classic	Uncorded	PillowPac™	29	200 PR/BX	\$30.65
CAB311-1101	Classic	Corded	Poly bag	29	200 PR/BX	\$57.96



### C. 3M™ E-A-Rsoft™ Yellow Neon™ Earplugs

The soft, smooth, tapered shape of the E-A-Rsoft earplug makes it extremely comfortable. The soft self-adjusting foam provides low pressure with excellent attenuation. The E-A-Rsoft Yellow Neon Blasts™ earplugs feature the same brilliant color, but are also decorated with exciting, blazing-red flames. Also offered in a SuperFit™ version, which features a patented “red ring” that takes the guesswork out of proper fit. NRR\* 33 dB. ANSI S3.19-1974.

SKU	Description	Type	Size	UOM	Price
CAB311-1250	Neons	Corded	Regular	200 PR/BX	\$51.58
CAB311-1252	Neon Blasts	Corded	Regular	200 PR/BX	\$52.35
CAB311-1254	SuperFit	Corded	Regular	200 PR/BX	\$58.25
CAB312-1250	Neons	Uncorded	Regular	200 PR/BX	\$25.38
CAB312-1252	Neon Blasts	Uncorded	Regular	200 PR/BX	\$28.76

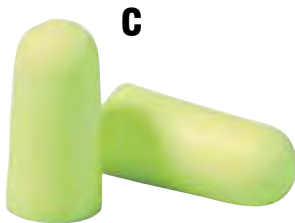

### D. 3M™ E-A-R™ CABOFLEX™ Model 600 Hearing Protector

The silicone pods contain a foam plug core for a sure fit. Pods swivel to properly align with and align with and fit a wide variety of ear canal sizes. The CABOFLEX is great for use with hard hats or safety glasses, when worn under the chin. NRR\* 20 dB.

SKU	Description	UOM	Price
CAB320-2001	CABOFLEX Model 600	EA	\$8.00

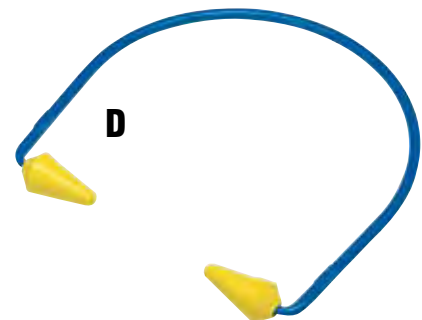

#### ⚠️ WARNING!

These hearing protectors help reduce exposure to hazardous noise and other loud sounds. Misuse or failure to wear hearing protectors at all times that you are exposed to noise may result in hearing loss or injury. For proper use, see supervisor, User Instructions, or call 3M in U.S.A. at 1-800-243-4630. In Canada, call Technical Service at 1-800-267-4414. If there is any drainage from your ear or you have an ear infection, consult with your physician before wearing ear plugs. Failure to do so may result in hearing loss or injury.

\*Research suggests that many users will receive less noise reduction than indicated by the NRR due to variation in earplug fit and wearing time. It is recommended that the NRR be reduced by 50% for estimating the average amount of noise reduction provided.



**A**



### A. Radians Eliminator™ 23 Earmuff

Radians Eliminator™ 23 earmuff is a lightweight, comfortable earmuff with a padded, adjustable headband. NRR 23 dB

SKU	Description	UOM	Price
RADEL23-B	Eliminator™ 23 Earmuff	EA	\$6.32

**B**



### B. Radians Eliminator™ 26 Earmuff

Radians Eliminator™ 26 earmuff is a lightweight, comfortable earmuff with a padded, adjustable headband. NRR 26 dB

SKU	Description	UOM	Price
RADEL26-B	Eliminator™ 26 Earmuff	EA	\$7.29

**C**



### C. Radians Eliminator™ 30 Earmuff

Radians Eliminator™ 30 premium earmuff provides excellent protection with superior comfort. The adjustable, padded moisture wicking headband moves moisture away from your head to keep you cool and comfortable. NRR 30 dB

SKU	Description	UOM	Price
RADEL30-BX	Eliminator™ 30 Earmuff	EA	\$18.17

**D**



### D. Radians Terminator™ 29 Earmuff

Radians Terminator™ 29 premium, lightweight earmuff provides excellent protection with superior comfort. The adjustable, padded moisture wicking headband moves moisture away from your head to keep you cool and comfortable. NRR 29 dB

SKU	Description	UOM	Price
RADTR29-BX	Terminator™ 29 Earmuff	EA	\$16.67



# Hearing Protection

## Earmuffs



### A. 3M™ Peltor™ Optime™ Series Earmuffs

These slim design muffs were specially engineered for high comfort and continuous wear. The two-point suspension exerts low pressure for comfortable, long-term use. The soft, liquid foam filled ear cushions provide added comfort and protection. Designed for use with welding helmets, sandblasting hoods, hard caps, bump caps and fire helmets. Not only protects from noise, but also protects from welding spatter which can cause ear and ear canal burns. NRR\* 21dB.

SKU	Description	Type	UOM	Price
PELH6B/V	H6 Series earmuff	Backband	EA	\$12.85

### B. 3M™ Peltor™ Optime™ Series Earmuff

The H9 Series is a lightweight, mid-range earmuff. It utilizes individual stainless spring steel headband wires and two low-tension points for even, comfortable alignment to the head. The broad foam cushions give low comfortable surface pressure.

SKU	Description	NRR*	Type	UOM	Price
PELH9A	H9 series earmuff	25	Headband	EA	\$16.74



### C. 3M™ Peltor™ Optime™ Series Earmuffs

The H10 Series represents the ultimate in earmuff technology by providing one of the highest protection levels in the industry coupled with Peltor's™ extensive list of performance and comfort features. The unique, patented dual cup design minimizes resonance to achieve maximum sound quality and attenuation without resorting to muff cups. A wide, soft padded headband distributes weight while two-point suspension exerts low pressure for comfortable, long-term use. The soft, foam-filled ear cushions provide added comfort.

SKU	Description	NRR*	Type	UOM	Price
PELH10B	H10 series earmuffs	29	Backband	EA	\$25.71

### D. 3M™ Peltor™ Optime™ Series Earmuffs

Deluxe personal hearing protector provides excellent attenuation at low and high frequencies. The soft, liquid foam-filled ear cushions provide added comfort. The H7 Series features simple height adjustment. The two-point suspension exerts low pressure for comfortable, long-term use.

SKU	Description	NRR*	Type	UOM	Price
PELH7B	H7 series	26	Backband	EA	\$20.20



#### WARNING!

These hearing protectors help reduce exposure to hazardous noise and other loud sounds. Misuse or failure to wear hearing protectors at all times that you are exposed to noise may result in hearing loss or injury. For proper use, see supervisor, User Instructions, or call 3M in U.S.A. at 1-800-243-4630. In Canada, call Technical Service at 1-800-267-4414. If there is any drainage from your ear or you have an ear infection, consult with your physician before wearing ear plugs. Failure to do so may result in hearing loss or injury.

\*Research suggests that many users will receive less noise reduction than indicated by the NRR due to variation in earplug fit and wearing time. It is recommended that the NRR be reduced by 50% for estimating the average amount of noise reduction provided.



### A. 3M™ Peltor™ Digital Worktunes AM/FM MP3 Earmuffs

The new Digital Worktunes gives workers the protection they need (NRR 26 dB) and the entertainment they want. Features include easy finger tip controls, 5 station presets, seek and scan, gel/foam cushions, MP3 cord included and long lasting battery power.

SKU	Description	NRR*	UOM	Price
PELWTD2600	Worktunes Earmuff AM/FM/MP3	26 dB	EA	\$92.00



A

**WARNING!**

These hearing protectors help reduce exposure to hazardous noise and other loud sounds. Misuse or failure to wear hearing protectors at all times that you are exposed to noise may result in hearing loss or injury. For proper use, see supervisor, User Instructions, or call 3M in U.S.A. at 1-800-243-4630. In Canada, call Technical Service at 1-800-267-4414. If there is any drainage from your ear or you have an ear infection, consult with your physician before wearing ear plugs. Failure to do so may result in hearing loss or injury.

\*Research suggests that many users will receive less noise reduction than indicated by the NRR due to variation in earplug fit and wearing time. It is recommended that the NRR be reduced by 50% for estimating the average amount of noise reduction provided.



by Honeywell



B

### B. QM24+® Earmuff

It is ultra-lightweight for prolonged usage, providing excellent protection for most environments. The QM24+ is a three-position, ultra-lightweight earmuff that weighs only 6 oz. The high visibility red cups and black band add style to an extremely functional earmuff. Supplied with an adjustable crown strap for a secure fit when worn behind the head or under the chin. Low-cost cushions are easily removed for replacement. NRR 25 dB.

SKU	Description	UOM	Price
HOWQM24	QM24+ earmuff	EA	\$7.16

### C. Thunder® Series Earmuffs

The Thunder series earmuff are designed with all-day comfort in mind. Thunder headband earmuffs features a unique dual-headband for better positioning and breathability, and non-deforming outer headband that minimizes pressure on the head. Plus, its dielectric construction withstands use and abuse, while protecting workers in electrical environments. The Thunder series features patented Air Flow Control™ technology for optimal attenuation across all frequencies and also snap-in ear cushions for easy maintenance. Quick-Click height adjustment keeps setting in place during wear. Special application models available, including cap-mounted [hard hat adapters included] and folding styles.

SKU	Description	NRR	UOM	Price
BIL1011600	Thunder T1 folding earmuff	25 dB	EA	\$13.34



C



D

### D. Leightning® Earmuffs

The Leightning series' steel wire construction provides high performance and robust durability. Leightning stands up to daily use and abuse without compromising comfort. The Leightning series has been optimized to deliver the highest level of comfort available, featuring an exclusive padded foam headband and super soft ear cushions that eliminate that "squeezing pressure" on the head. Features patented Air Flow Control™ technology for optimal attenuation across all frequencies and snap-in ear cushions for easy maintenance. Special application models available, including cap-mounted [hard hat adapters included] and neckband styles.

SKU	Description	NRR	UOM	Price
HOWL3	Leightning L3	30 dB	EA	\$21.56
BIL1013460	Leightning LON ultraslim earcups neckband	22 dB	EA	\$9.48





**A**

### A. Casella CEL-300 Series Convertible Noise Dosimeters

The CEL-300 Series includes the CEL-320 and CEL-360 dosimeters which can be converted to the CEL-320S and CEL-360S sound level meters by simply exchanging the cable microphone assembly for a traditional stalk microphone and preamplifier. They are the ideal instruments for any form of personal worker surveys when considering the possible risk of hearing loss in the workplace. Conversion to a compact sound level meter enables comprehensive noise measurements to be carried out with the possibility of storage of the results for later recall from memory.

SKU	Description	UOM	Price
CEL320/K1	Noise dosimeter kit	EA	\$2061.50
CEL320S/K1	IS noise Dosimeter kit	EA	\$2178.17
CEL360/K1	Logging noise Dosimeter kit	EA	\$2790.67

### B. Casella dBadge2 Personal Noise Dosimeter

The dbadge2 retains all the great features that made the CEL-35x series so successful but Casella has added powerful new capabilities that will completely change the way use dosimeters - to save you and your workers time, money and even prevent costly errors or mistakes - because they have revolutionized how personal dosimetry gets done! Imagine being able to view noise exposure data from multiple workers, REMOTELY right on your cellphone or tablet! That's right, now you can access each ANSI/IEC standards compliant dBadge2 dosimeter directly from your HHD using the built-in Bluetooth®4.0 connection and the Casella Airwave™ App!

SKU	Description	UOM	Price
CELD2K1	dBadge2 Noise Dosimeter 1 pack kit	EA	\$3184.21
CELD2K2	dBadge2 Noise Dosimeter 2 pack kit	EA	\$5007.01
CELD2K3	dBadge2 Noise Dosimeter 3 pack kit	EA	\$6829.81
CELD2K5	dBadge2 Noise Dosimeter 5 pack kit	EA	\$10247.56
CELD2K10	dBadge2 Noise Dosimeter 10 pack kit	EA	\$18222.31



**B**



### C. 3M™ Noise Indicator NI-100

Innovative and durable noise detection, the NI-100 noise indicator alerts you when noises in an area reach potentially hazardous levels. The noise indicator's small size and lightweight design make it ideal for workers in a variety of industries. With a rechargeable battery that operates for up to 200 hours between charges, it's an economical investment in your hearing conservation program. The NI-100 can be used as an effective training tool within a Hearing Conservation Program (consult OSHA Standard 1910.95) to help ensure workers know when and where to wear hearing protection. Safety and health professionals can also use it as a mapping tool to determine where noise studies are necessary. In a variable noise environment, the 3M noise indicator can help train workers as to when noise levels become potentially hazardous and hearing protection may be required.

- Red Flashing LED indicates noise levels are above 85 dBA and hearing protection may be required.
- Green Flashing LED indicates noise levels are below 85 dBA and hearing protection may not be necessary.

*\*The NRR may overestimate the hearing protection provided during typical use. 3M recommends reducing the NRR by 50% for estimating the amount of noise reduction provided. 3M is Leading the Advancement of Hearing Conservation™. 3M™ Noise Indicator NI-100 is not Intrinsically Safe.*

SKU	Description	UOM	Price
3MNI-100	Noise Indicator NI-100, 10/CS	CS	\$434.13

IMPORTANT: For appropriate use of hearing protection, consult your company's safety professional or applicable local safety standards

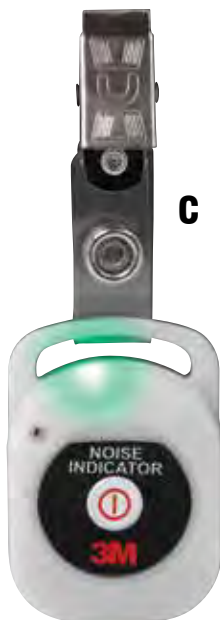

**C**



# Footwear





**A**

### A. Men's Timberland PRO® Boondock WP Safety Toe Work Boot

The Timberland PRO® Boondock Work Boot features premium waterproof leather with waterproof membrane and Ever-Guard™ leather heel for abrasion resistance and dry feet. Molded Timberland PRO® rubber toe protector for increased abrasion resistance and durability. Composite safety toe shaped on TITAN® last for non-metallic protection and a superior fit. Combination three-quarter Goodyear welt/cement heel construction and rigid external heel cup for lateral stability. Dual-density thermal plastic urethane (TPU) outsole features deep lugs for traction and is slip-, oil- and abrasion-resistant. Padded top collar, fiberglass shank for structural support and dual-density dynamic anti-fatigue technology absorbs shock and returns energy at key zones of the foot.

SKU	Description	UOM	Price
TIM92615	Boondock WP Safety Toe Work Boot	PR	\$162.75

### B. Men's Timberland PRO® TITAN® 6" Safety Toe

Timberland's lightest work boots. Engineered in premium waterproof dark mocha brown leather and packed with features for the jobsite including Timberland's TITAN® Safety Toe protection, Electrical Hazard protection to keep you safe from open circuits and a rebound heel insert for durable cushioning and energy return.

SKU	Description	UOM	Price
TIM26078	Titan® 6" lace-up, brown leather, steel toe	PR	\$138.33

**B**



**C**

### C. Men's Timberland PRO® Helix 6" WP Safety Toe

The Titan 85594 Helix 6" lace-up is made with a rugged full-grain waterproof leather and waterproof membrane. It has a Titan® alloy safety toe for lightweight protection and roomy fit. Other features include mesh lining with Agion® anti-microbial treatment, contoured single-density open-cell polyurethane footbed, anti-fatigue technology with conical midsole geometry, and molded EVA midsole for lightweight cushioned comfort.

SKU	Description	UOM	Price
TIM85594	Titan® 6" lace-up, brown leather, steel toe	PR	\$152.98

### D. Men's Timberland PRO® Rigmaster 8" Steel Toe WP Boot

Rigmaster is from Timberland's series of industrial traction workboots. Engineered specifically to provide workers in the oil and gas industries with exceptional slip resistance, this polyurethane outsole has triangular-shaped lugs in a multi-directional pattern for a mechanical grip. Features include: waterproof full-grain leather with waterproof membrane, Goodyear® Welt Cast-Bond™ construction for a durable chemical and mechanical bond, TITAN® steel toe for a roomy fit, anti-fatigue conical midsole geometry, featuring polyurethane material, mesh lining with Agion® anti-microbial treatment, contoured single-density OrthoLite® footbed, quick-release hardware, aggressive tread design features triangular lock lugs that provide maximum traction, sole is oil-, heat-, and abrasion-resistant and features Ladder Lock™ outsole radius.

SKU	Description	UOM	Price
TIM95553	Rigmaster 8" lace-up, brown leather, steel toe	PR	\$158.68

**D**



**E**



### E. Men's Timberland PRO® Helix Met Guard 6" Boot

The Timberland PRO® Helix collection is in a class of its own, this boot features premium full-grain leather for comfort and abrasion resistance. Timberland PRO® rubber "double toe" for abrasion resistance and durability; Timberland PRO® rubber outsole features Ladder Lock™ outsole radius to better grip ladders and is slip-, oil-, and abrasion-resistant. Composite safety toe is shaped on TITAN® last for non-metallic protection. Anti-fatigue technology with conical geometry in polyurethane inner midsole reduces shock and returns energy to the foot. Internal, anatomical, breathable open-cell polyurethane and rubber anti-fatigue technology metatarsal guard for comfortable protection. Molded EVA outer midsole for lightweight, cushioned comfort. Mesh lining with antimicrobial treatment for odor control and contoured single-density open-cell polyurethane footbed with antimicrobial cover for breathable comfort and odor control.

SKU	Description	UOM	Price
TIM89697	Helix Met Guard 6" Boot	PR	\$157.05

### A. Men's Timberland PRO® AG Boss Alloy Toe Pull-On Work Boots

Timberland Pro's AG Boss work boots feature ultimate comfort, waterproof job site protection and Western-inspired styling. The slip-resistant lug outsoles keep you grounded, and Timberland has added anti-fatigue technology, antimicrobial mesh linings and easy pull-on tabs. Patented COOLMAX® thermoregulation technology lining helps to maintain a consistent comfort zone and Smart Comfort® technology medial shift expansion seam for easy on/off.

SKU	Description	UOM	Price
TIM91636	AG Boss Alloy Toe Pull-On Work Boots	PR	\$210.53

A



B

### B. Men's Timberland PRO® Mortar Pull-On Composite Toe Work Boot

Timberland PRO® Mortar Pull-On Composite Toe Work Boot features a non wicking air textured nylon ballistic weave with a "blood borne pathogen" certified waterproof membrane that allows foot perspiration to escape while providing a protective barrier against chemicals and various liquids creates the ultimate in foot protection and comfort on and off the job. Stitched-on oil resistant rubber toe provides enhanced abrasion resistance above and beyond the ballistic textile performance. Non-metallic composite toe cap based on the TITAN shape for proven lightweight ergonomic protection.

SKU	Description	UOM	Price
TIM1059A	Mortar Pull-On Composite Toe Work Boot	PR	\$179.02

### C. Men's Timberland PRO® Helix Waterproof Wellington Work Boot

The 88537 Timberland PRO® Helix Waterproof Wellington Boot features premium waterproof leather with waterproof membrane, composite safety toe shaped on TITAN®, cement construction, Anti-Fatigue Technology with conical geometry in polyurethane midsole, unique "finger-grip" pull-on feature, molded EVA midsole, mesh lining with Agion® antimicrobial treatment and contoured single-density open-cell polyurethane footbed with Agion® antimicrobial cover. Timberland PRO® rubber outsole is slip-, heat-, oil- and abrasion resistant and features Ladder Lock™ outsole radius. Imported

SKU	Description	UOM	Price
TIM88537	Helix Waterproof Wellington, safety toe	PR	\$173.32

C



D

### D. Men's Timberland PRO® Excave Wellington Steel Toe Work Boot

The 87559 Timberland PRO® Excave Wellington Steel Toe features rugged full-grain leather and fabric upper, steel safety toe, cement construction, unique "finger-grip" pull-on feature, mesh lining with Agion® antimicrobial treatment, steel shank, contoured single-density open-cell polyurethane footbed with Agion® antimicrobial and rubber lug outsole is non-marking, oil-resistant and features Ladder Lock™ outsole radius. Imported

SKU	Description	UOM	Price
TIM87559	Excave Wellington, steel toe	PR	\$113.92

### E. Women's Timberland PRO® Titan 6" Steel Toe Work Boot

The Women's 6" Titan is made of waterproof full-grain leather with waterproof membrane; it is 360° of lightweight comfort. Soft leathers to minimize break-in time and TITAN alloy safety toe for lightweight protection and roomy fit. Moisture-channeling spacer mesh comfort lining with Agion antimicrobial treatment keeps foot dry and comfortable. Polyurethane midsole for lightweight, durable cushioning and nylon diffusion shank for torsional rigidity. Cast metal top stud hooks.

SKU	Description	UOM	Price
TIM53359	Titan 6" Steel Toe Work Boot	PR	\$117.99

E







**A**

### A. Men's Timberland PRO® TiTAN® Slip-On Safety Toe

Timberland's footwear is made for you, the working professional who takes pride in your job. We take pride in our job also, by putting attention to detail in everything we make. Timberland's industrial casual shoes are packed with features for the office, warehouse or jobsite including our PowerFit™ comfort system and a lightweight TiTAN® safety toe.

SKU	Description	UOM	Price
TIM53534	TiTAN® slip-on, steel toe, brown	PR	\$101.71

### B. Men's Timberland PRO® Branston Alloy Toe Slip-On Shoe

Timberland's Branston Alloy Toe features the rugged good looks of a traditional Timberland® slip-on shoe and the performance features of our Timberland PRO® line. This Slip-On Shoe also features premium full-grain leather for comfort and abrasion resistance, alloy safety toe for lightweight protection, cement construction for flexibility and reduced break-in time, padded top collar for comfort, fiberglass shank for structural support, conductive polyurethane mid-sole for consistent static-dissipative performance, dynamic anti-fatigue technology absorbs shock and returns energy back to the foot, Agion® antimicrobial treatment for odor control and comfortable feet and a non-marking Timberland PRO® polyurethane outsole is slip- and oil-resistant.

SKU	Description	UOM	Price
TIM91694	Branston Alloy Toe Slip-On Shoe	PR	\$113.92



**B**



**C**

### C. Timberland PRO® Anti-Fatigue Technology Insole

Timberland PRO® footwear is designed to handle the specific conditions and environment of your job, and these insoles offer a carefully engineered upgrade in both performance and comfort. The Anti-Fatigue Technology Insole features our exclusive inverted cone foam, designed to absorb shock and return energy to your feet with every step, decrease fatigue and keep you going during long hours at the worksite.

SKU	Description	Sizes	UOM	Price
TIM91621	Anti-Fatigue Technology Insole	XS-2X	EA	\$24.41



by Honeywell

### D. Oliver 8" Lace-Up Work Boot

This 8" lace up boot features a Heavy Duty AT's All Terrain Dual Density PU / Rubber Sole, heat resistant to 572° F and resists exposure to most acids and chemicals, NATUREform wide profile safety toecap, with latex comfort liner under the cap to eliminate toe discomfort, NANOLite footbed massages your feet as you walk, promoting greater blood flow to help reduce fatigue, COMFORTcushion impact absorption system with PORON®, caustic and water resistant leather, PORON® XRD™ Flexible Internal Metatarsal Guard, Kevlar thread on critical wear seams for maximum abrasion and chemical resistance, Integrated TPU SAFETYcell for maximum protection and durability, anti-static sole and lace in quick release zipper attachment.

SKU	Description	UOM	Price
OLB65392	8" Lace-Up Work Boot	PR	\$207.02



**D**



### A. 8" Moc Toe Safety Toe

The Thorogood 8 Inch Moc Toe Safety Toe features atobacco oil-tanned leather upper, Goodyear storm welt construction, cotton drill vamp lining, removable Dual Density Ultimate Shock Absorption™ Footbed on Poron® 4000 Comfort Cushion insole, rubber midsole, engineered composite shank, and Thorogood Exclusive MAXwear Wedge™ outsole. ASTM F2413-11 M I/75/C/75 Steel Toe. EH Rated. Tested For and Meets CAN/CSAZ195 18,000 Volts Electric Shock Resistance Standard.

SKU	Description	UOM	Price
TG4208	8" Moc Toe safety toe	PR	\$165.00

A



B

### B. Wellington 8" Side-Zipper Composite Toe Work Boot

The Wellington 8" side-zipper composite toe work boot has a tumbled oiled full-grain leather upper and a Goodyear Storm Welt construction, it also features a spacer mesh lining, polyurethane removable footbed / Special EVA Cushion Flex, compression molded EVA with Impact 300 Gel Heel insert, engineered composite shank, Anti-Roll Bar Heel Support (ABHS) and Gen Flex II Dual Density Slip Resistant Rubber outsole. Tested for and Meets CAN/CSA-Z195 18,000 Volts Electric Shock Resistance Standard

SKU	Description	UOM	Price
TG4440	Wellington 8" side-zipper composite toe work boot	PR	\$130.00

### C. Wellington Pull-On Safety Work Boot

The Wellington safety work boot features a Direct Injection construction with a Root Beer Old West Tumbled full grain leather upper. It also features a Comfort Weave lining, removable Dual Density Polyurethane "SHOCK ZONE" Footbed, engineered composite shank and Soft Streets™ Dual Density Polyurethane outsole. ASTM F 2413-05 M/I/75/C/75 Steel Toe. "Unlined" Shaft. Electrical Hazard. Tested For and Meets CAN/CSA-Z195 18,000 Volts Electric Shock Resistance Standard.

SKU	Description	UOM	Price
TG4580-	Wellington pull-on safety work boot	PR	\$166.67

C



D

### D. American Heritage Job Pro 8" Safety Toe Work Boot

The American Heritage – Job Pro 8" Safety Toe Work Boot features a brown trail Crazyhorse oil-tanned leather upper, Goodyear Storm Welt construction, cotton drill vamp lining, removable Dual Density Ultimate Shock Absorption™ Footbed on Poron® 4000 Comfort Cushion insole, rubber midsole: engineered composite shank and polyurethane "White 90" Comfort Sole outsole ASTM F2413-11 M I/75/C/75 Steel Toe. EH Rated. Tested For and Meets CAN/CSA-Z195 18,000 Volts Electrical Shock Resistance Standard.

SKU	Description	UOM	Price
TG4379	American Heritage Job Pro 8" Safety Toe Work Boot	PR	\$160.00

### E. American Heritage Job Pro 8" Moc Toe Safety Toe Work Boot

American Heritage Job Pro 8" Moc Toe Safety Toe Work Boot features a Brown Trail Crazyhorse oil-tanned upper leather, Goodyear Storm Welt construction, removable dual density Ultimate Shock Absorption™ Footbed on Poron® 4000 Comfort Cushion insole and single-density polyurethane MAXWear Sole with 90° heel outsole.

SKU	Description	UOM	Price
TG4378	American Heritage Job Pro 8" Moc Toe Safety Toe Work Boot		\$178.95

E





**A**

### A. At Work Crew 3-Pack

Crew cut socks that feature order guard, protects against odor causing bacteria. Long wearing sole, stay put leg stop and cushiony foot.

Contents: 67% Cotton, 17% Acrylic, 13% Stretch Nylon, 3% Elastic (rubber)

SKU	Description	Size	UOM	Price
WIGS1221B	At Work Crew 3-pack Black	M-XL	PK	\$10.88
WIGS1221SG	At Work Crew 3-pack Sweatshirt Grey	M-XL	PK	\$10.88

### B. At Work Double Duty 2-Pack

Crew cut socks that feature order guard, protects against odor causing bacteria. Long wearing sole, stay put leg stop, cushiony foot, and seamless toe closure.

Contents: 35% Wool, 35% Acrylic, 23% Stretch Nylon, 7% Olefin

SKU	Description	Size	UOM	Price
WIGS1350	At Work Double Duty 2-Pack Grey	M-XL	PK	\$13.68



**B**



**C**

### C. At Work Quarter 3-Pack

Quarter length socks that feature order guard, protects against odor causing bacteria. Long wearing sole, stay put leg stop and cushiony foot.

Contents: 85% Cotton, 10% Stretch Nylon, 3% Polyester, 2% Elastic (rubber)

SKU	Description	Size	UOM	Price
WIGS1360	At Work Quarter 3-Pack Sweatshirt Grey	M-XL	PK	\$9.82

### D. Super 60® Crew, Quarter & Low-Cut Spare Pair

Crew, Quarter & Low-Cut length cotton athletic sock in a 7-pack.

Contents:

85% Cotton, 15% Stretch Nylon

SKU	Description	Size	UOM	Price
WIGS9004	Socks Super 60 Quarter White 7-PR/PK	M-XL	PK	\$15.97
WIGS9005M	Socks Super 60 Low-Cut White 7-PR/PK	M	PK	\$15.35
WIGS9005L	Socks Super 60 Low-Cut White 7-PR/PK	L	PK	\$15.35
WIGS9010	Socks Super 60 Crew White 7-PR/PK	M-XL	PK	\$17.80



**D**



**E**

### E. Merino Comfort Hiker Lite

Crew cut socks that feature long wearing sole, stay put leg stop, cushiony foot, and seamless toe closure.

Contents: 61% Merino Wool, 30% Stretch Nylon, 6% Acrylic, 3% Elastic (rubber)

SKU	Description	Size	UOM	Price
WIGF2409G	Socks Merino Comfort Hiker Lite Grey	M-XL	PR	\$10.43
WIGF2409N	Socks Merino Comfort Hiker Lite Navy Blue	M-XL	PR	\$10.43





### A. Arctic Pro Steel Toe

The Arctic Pro Steel Toe is a professional extreme, conditions work boot to keep you working at your best when Mother Nature is at her worst. This boot features an 8mm CR flex-foam bootie with four-way stretch nylon that snugs the leg to keep warmth in and cold out. Fleece lining adds warmth for wearer comfort, even at temperatures down to -60° F. 100% waterproof, lightweight and flexible. 2mm thermal foam underlay added to the instep area for additional warmth, EVA molded midsole with contoured footbed, bob-tracker molded outsole is rugged, aggressive and durable for maximum protection and stability and meets ASTM F2413-11 M I/75 C/75 EH.

SKU	Description	Sizes	UOM	Price
SRVACPBLK	Arctic Pro Steel Toe, Black	7-14	PR	\$204.92



A



B

### B. Arctic Sport Steel Toe

The Arctic Sport Steel Toe is an extreme conditions work boot to keep you working at your best when Mother Nature is at her worst. This boot features an 8mm CR flex-foam bootie with four-way stretch nylon that snugs the leg to keep warmth in and cold out. 100% waterproof, lightweight and flexible. It has a fleece lining, 2mm and a thermal foam underlay added to the instep area for additional warmth. EVA molded midsole with contoured footbed and MS-1 molded outsole is rugged, aggressive and durable for maximum protection and stability. Meets ASTM F2413-11 M I/75 C/75 EH

SKU	Description	Sizes	UOM	Price
SRVASPBLK	Arctic Sport Steel Toe, Black	7-14	PR	\$195.16

### C. Chore Cool Steel Toe

The best-selling Chore Muck Boot now features XpressCool™ fabric lining to rapidly pull moisture away from skin to dryer areas of the boot - as moisture spreads it creates a cooling affect. The Chore Cool Steel Toe features a 4mm neoprene bootie with four-way stretch nylon that is 100% waterproof, lightweight and flexible. The upper is triple reinforced in the toe area and quadruple reinforced in the heel area. It has a steel shank for additional arch support, etc® sockliner lining to reduce friction and heat buildup, new Vibram® outsole for improved durability and performance and Spandura® added to the exterior of the neoprene for added protection against wear and abrasion. Meets ASTM F2413-11 M I/75 C/75 EH

SKU	Description	Sizes	UOM	Price
SRVCSTBL	Chore Cool Steel Toe	5-14	PR	\$156.11



C



D

### D. Chore Pro Cool Steel Toe

The Chore Pro Cool Steel Toe features XpressCool™ fabric lining to rapidly pull moisture away from skin to dryer areas of the boot - as moisture spreads it creates a cooling affect. It has a etc® sockliner lining to reduce friction and heat buildup, new Vibram® outsole for improved durability and performance, full rubber coverage and 4mm CR flex-foam bootie with four way stretch nylon that is 100% waterproof, lightweight and flexible. Meets ASTM F2413-11 M I/75 C/75 EH

SKU	Description	Sizes	UOM	Price
SRVCPCTBL	Chore Pro Cool Steel Toe, Black	5-16	PR	\$170.76



**A**

### A. 16" Black Metatarsal Knee Boot

Perfect for hazardous, heavy-duty jobs, the Turtleback features Safe-Toe steel toe construction, anchored metatarsal guard, Safe-Step steel midsole and Trac Tread™ sole and heel. The outsoles are high abrasion rubber for durability and longer wear. 100% waterproof rubber construction. Meets ASTM F2413-11 M I/75 C/75 Mt/75 PR Made in the U.S.A

SKU	Description	Sizes	UOM	Price
SRVR2145	16" Full Metatarsal Midsole Steel Toe	6-14	PR	\$127.82

### B. Stormking

The 31 inch rubber Stormking with pull-on-loops, Trac Tread sole and heel. Made in U.S.A. These 100% waterproof, non-safety toe boots feature commercial grade rubber uppers that are specially formulated to prevent ozone deterioration. Steel shanks reinforce construction and support the feet, while cushion insoles reduce fatigue for all-day comfort.

SKU	Description	Sizes	UOM	Price
SRV11444	SEAFARER stormking, 31" rubber boot	8-13	PR	\$127.41



**B**



**C**

### C. Servus® PRM

The 15" Servus PRM was developed to meet the needs of workers in many industries including mining, construction, breweries, utilities and municipalities. PRM™ features a steel toe for impact protection and steel midsole for puncture protection. 100% waterproof PVC injection molded construction. Meets ASTM F2413-11 M I/75 C/75 PR EH

SKU	Description	Sizes	UOM	Price
SRV75145-	15" PRM rubber boot steel toe	7-14	PR	\$40.02



### D. Dielectric Work Boot

Dielectric overshoes are made from ozone resistant yellow rubber. The construction is hand layered in full cut patterns to easily fit over work boots. These overshoes are 100% waterproof. The lining is fabric, so it is easy to slip on and off. The sole is an anti-skid bar tread. The outsole of these boots have been tested to 20,000 volts to the electrical hazard requirements of ASTM F2413-05.

SKU	Description	Sizes	UOM	Price
SRV31924	Dielectric work boot	6-17	PR	\$190.29



**D**

**SERVUS**<sup>®</sup>

by Honeywell

**A. Servus<sup>®</sup> Neoprene III**

Servus dipped Neoprene boots feature a highly specialized construction of hand laid natural rubber and triple-dipped process to ensure a water-tight boot. Chevron outsole is self-cleaning and provides excellent traction on surfaces with liquid and debris.

Two heights are available and both meet ASTM F2413-11 M I/75 C/75 EH

SKU	Description	Sizes	UOM	Price
SRV22114	12" Copper Tan Neoprene Steel Toe	4-15	PR	\$90.06
SRV22214	15" Copper Tan Neoprene Steel Toe	4-15	PR	\$92.13

**TINGLEY**  
A TRADITION SINCE 1896**B. Neoprene Snugleg Boots**

Tingely's Neoprene Snugleg Boots are made with a multi-ply manufacturing method. Every boot is triple dipped with two neoprene coatings and one sealant, so the foot is surrounded by a layer of 100% waterproof and chemical resistant neoprene for optimum protection and extraordinary comfort.

SKU	Description	Sizes	UOM	Price
TINGMB921B	Neoprene boot 16" red/brwn steel toe	6-15	PR	\$87.30
TINGMB922B	Neoprene boot 12.5" red/brwn steel toe	6-15	PR	\$85.67

**C. General Purpose PVC Knee Boot**

When you are working in wet, muddy conditions, our General Purpose PVC knee boot provides easy walking and all day protection.

SKU	Description	Sizes	UOM	Price
TING31244	Contractor boot PVC steel toe	7-14	PR	\$14.40

**D. The Premier<sup>™</sup> PVC Boot**

Tingely's Premier boot is tough, yet extremely comfortable. The Premier's unique blend of high molecular weight PVC resins and specialty additives offers superior chemical resistance to concentrates of fats, certain acids, hydrocarbons, caustics, and other chemicals. That's why it is an excellent choice for food processing and petrochemical applications.

SKU	Description	Sizes	UOM	Price
TING93245	Premier maroon boot steel toe	6-14	PR	\$44.02



# SERVUS®

by Honeywell



**A**

### A. Servus® 15" Iron Duke®

PVC polyblend injection molded work boots combine flexible and comfortable uppers with durable and hard wearing outsoles. Steel toe impact protection, 15 inch height. Deep angle cleat outsole helps to grip slick surfaces to help prevent slips and falls. Meets ASTM F2413-11 M I/75 C/75 EH

SKU	Description	Sizes	UOM	Price
SRV18801	Injection molded	6-13	PR	\$30.71

### B. Servus® CT™ PVC Boot

Seamless injection molded PVC footwear is 100% waterproof. Flexible and durable upper and specialized top-line design allows for freedom of movement. Steel toe impact protection, 14 inch height. Deep angle cleat outsole helps to grip slick surfaces to help prevent slips and falls. Boot with steel toe meets ASTM F2413-11 M I/75 C/75 EH. Non-safety toe boot meets ASTM F2413-11 EH.

SKU	Description	Sizes	UOM	Price
SRV18821	Black PVC - Steel toe	6-15	PR	\$17.64
SRV18822	Black PVC - Plain toe	6-14	PR	\$15.36



**B**

### C. Servus® "Pro"

PVC footwear featuring TDT innovations for a seamless injection molded work boot that combines compounds engineered to withstand organic and chemical deterioration. Dual compound outsole provides a soft inner sole and harder perimeter for outstanding surface to surface contact and slip-resistance. Boot is 100% waterproof, 15 inch height. Meets ASTM F2413-11 M I/75 C/75 EH.

SKU	Description	Size	UOM	Price
SRV75101	Gray PVC blend	6-13	PR	\$46.07



**C**

### D. Servus® 6" Iron Duke

6" black PVC, steel toe, 5-eyelet, safety shoe, anti-skid sole and heel. The choice for superior durability and performance year after year! Safety steel toe for added protection, foot form contour insole for comfort. Meets ASTM F2413-11 M I/75 C/75 EH

SKU	Description	Sizes	UOM	Price
SRV73104	Black PVC Safety Shoe, Steel Toe	6-13	PR	\$30.71



**D**



### A. Chest Waders

Insulated, all rubber chest waders. Vulcanized construction is 100% waterproof for all day wearer comfort. Polymeric foam insulation in boots, and soft cotton lining. Inside chest pocket, non-safety toe, steel shanks to provide added arch support, and heavy TracTread™ outsoles to take on tough terrain. Suspenders sold separately.

SKU	Description	Sizes	UOM	Price
SRVA2070	Chest waders	6-14	EA	\$105.41
SRV20000	Suspenders for chest waders		EA	\$16.24



### B. Hazproof® Boot

Made of special polymer material, this comfortable boot meets the protective footwear chemical permeation requirements of NFPA 1991 Standard on Vapor-Protective Ensembles for Hazardous Materials Emergencies 2005 Edition. With the growing reality that chemical warfare agents are now a threat to the civilian population, domestic preparedness programs are developing rapidly. The HazProof boot has also been tested to Military Standard 282 and will provide protection against certain chemical warfare blister and nerve agents!

SKU	Description	Sizes	UOM	Price
TING82330	Hazproof boot 11" steel toe	7-13	PR	\$90.00



### C. Yellow Latex Bootie

12" latex bootie, disposable, stretch overshoe bootie, textured outsole, slip resistant, 100% waterproof.

SKU	Description	Size	UOM	Price
SRVA352L	Disposable overboot	L	CS	\$314.55
SRVA352XL	Disposable overboot	XL	CS	\$314.55
SRVA3522X	Disposable overboot	XXL	CS	\$314.55





# Safety Overshoes Keep You On Your Feet



**Ice & All Surface Overshoe**  
Reduce Slips & Falls Outdoors



**Safety Overshoe**  
Protects Toes from Impact



## A. Tiger Grip® Visitor Overshoe

Visitor is a safety toe-cap overshoe made to protect visitors to industrial sites against crushed toes and impacts. Visitor's toe-cap is made of aluminum/titanium alloy ( 50% lighter, but as resistant as steel ). With its Tiger Grip® anti-slip technology sole, you will easily walk on wet or greasy surfaces too.

SKU	Description	Size	UOM	Price
TGRVISS	Visitor Overshoe	SM 5.5	PR	\$41.75
TGRVISM	Visitor Overshoe	MD 6-9.5	PR	\$41.75
TGRVISXL	Visitor Overshoe	XL 10-13+	PR	\$41.75

## B. Tiger Grip® Total Protect Overshoe

As a worldwide innovation, TOTAL-PROTECT is intended to protect against slipping risks and toe crush injuries. Safety cap is made of an aluminum/titanium alloy, 50% lighter than steel but as resistant. The antislip sole from Tiger Grip® technology secures all your moves on greasy or wet floors and guarantee security and comfort. TOTAL PROTECT is a real alternative for a better safety on the workplace.

SKU	Description	Size	UOM	Price
TGRTOTS	Total Protect Overshoe	SM	PR	\$41.60
TGRTOTM	Total Protect Overshoe	MD	PR	\$41.60
TGRTOTL	Total Protect Overshoe	LG	PR	\$41.60
TGRTOTXL	Total Protect Overshoe	XL	PR	\$41.60





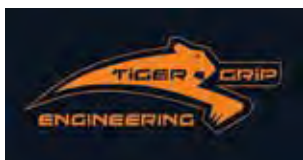

### A. Tiger Grip® Master-Grip Overshoe

This overshoe will allow you to walk as well on snow and ice as well as on muddy surfaces. Master-grip overshoes have 4 interchangeable studs that you can adapt to your needs.

SKU	Description	Sizes	UOM	Price
TGRMASS	Master-Grip Ice and All-Surface Overshoe	SM 5.5	PR	\$44.28
TGRMASM	Master-Grip Ice and All-Surface Overshoe	MD 6-9.5	PR	\$44.28
TGRMASXL	Master-Grip Ice and All-Surface Overshoe	XL 10-13	PR	\$44.28



### B. Trex Adjustable one-piece traction device

Adjustable one-piece traction device for shoes or boots delivers tenacious grip and stability.

Features:

- Rugged steel studs for tenacious grip & stability
- Adjustable cord cinches tight for a secure fit
- Stretchable rubber for fit and easy on/off
- Aggressive tread connects mid-foot and heel stud zones
- Reflective pull-on tab adds enhanced visibility
- Flexible to -40°F (-40°C)

SKU	Description	Size	UOM	Price
ERG6310M	Trex adjustable one-piece traction device for shoes or boots	M	PR	\$22.05
ERG6310L	Trex adjustable one-piece traction device for shoes or boots	L	PR	\$22.05
ERG6310XL	Trex adjustable one-piece traction device for shoes or boots	XL	PR	\$22.05



### C. Stainless Steel Insole

A stainless steel insert that is flexible and cushion-covered. It will not deteriorate and fits into most boots.

SKU	Description	Sizes	UOM	Price
SRV29000-	Puncture-resistant midsole	5-14	PR	\$17.02





**A**

### A. Foot and Shin Combination Guards

Rugged aluminum alloy foot and shin guards fastened to permit free leg movement in any direction. Shin guard covers front of leg through 180 degrees; full height 16-3/4".

SKU	Description	UOM	Price
ELW400	Foot and shin combination guards, aluminum	PR	\$99.75

### B. Metatarsal Guard

Comfortable and low-cost protection are standard to this aluminum alloy Metatarsal Guard. Designed to be worn with most lace-type steel-toed safety shoes. Can withstand an impact of over 75 foot-pounds. Weighs only 4-1/2 oz. One size fits all.

SKU	Description	UOM	Price
ELW800	Metatarsal Guard	PR	\$32.92
ELW801	Metatarsal Guard w/ spring for non-lace-up	PR	\$34.50



**B**



**C**

### C. Foot Guards

Foot guards fit any shoe (no rights or lefts), with 5" (average) and 5-1/2" (large) widths. They are light enough to be worn comfortably all day. To keep the guard properly positioned, it has a rubber toe clip, crossbar, and either a one-piece rubber strap with a tension buckle, or a two-piece leather strap with a spring fastening device. Made of .081" aircraft quality aluminum alloy.

SKU	Description	Size	UOM	Price
ELW200	Foot guard w/ rubber toe	L	PR	\$47.83
ELW200XL	Foot guard w/ rubber toe	XL	PR	\$61.92
ELW202	Foot guard w/ full sole	L	PR	\$77.21

### D. Plastic Foot Guard

Lightweight, comfortable, economical, rugged Thermo-Foam plastic guards withstand impact of 50 foot-pounds. Rubber straps on sole and heel slip on and off easily, one size fits all.

SKU	Description	UOM	Price
ELW500	Plastic foot guard	PR	\$24.42

**D**



**E**

### E. Toe Guard

Protect toes from injury with this 16-gauge carbon steel Toe Guard. Weighs only 12 oz, yet can withstand an impact of over 75 foot-pounds. Features a quick fastener and an adjustable strap. Easy to put on. Exceptionally comfortable.

SKU	Description	Size	UOM	Price
ELW702	Toe Guard	Men's	PR	\$29.07

# Welding

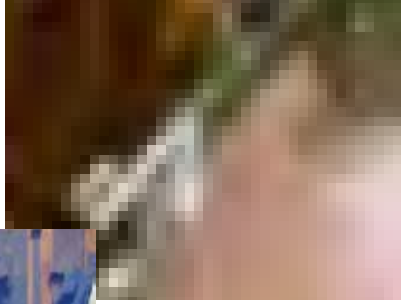
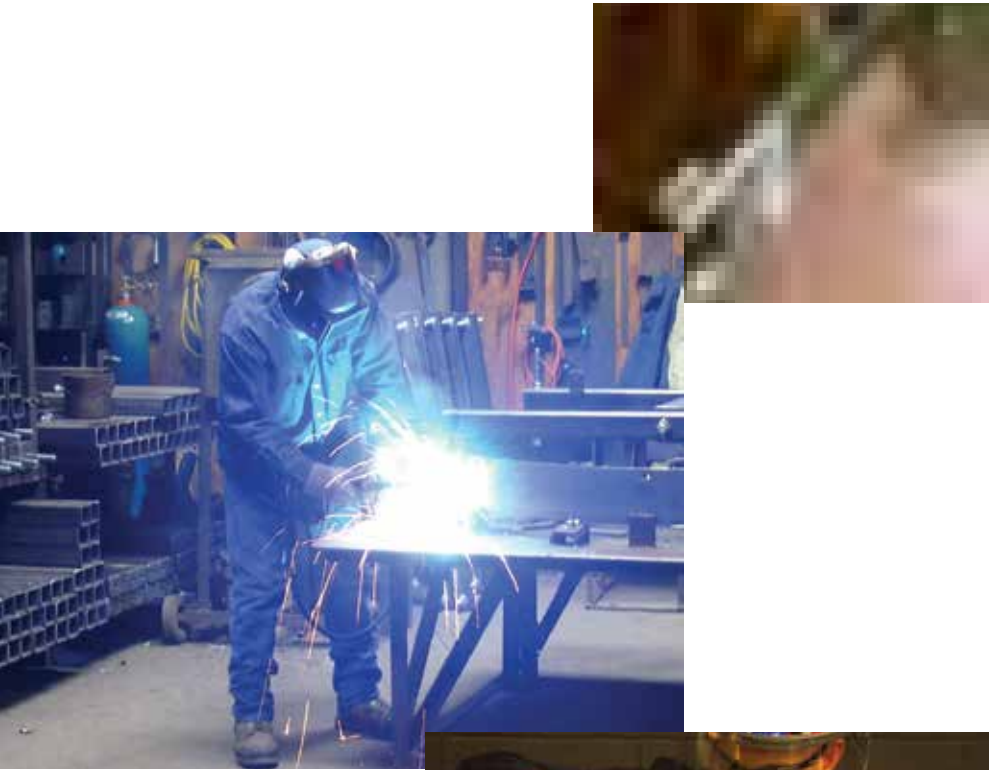





3M0606000SW

**A**



3M060600  
10SW/20SW/30SW

### A. 3M™ Speedglas™ 9100 FX Welding Helmet

The new 9100 FX combines legendary Speedglas quality and auto darkening technology with an innovative wide-view grinding visor to give welders an all-in-one solution for more flexibility, precision, and efficiency.

The exceptionally clear, wide grinding visor offers a greater field of view in all directions, while a smooth flip-up pivot mechanism assures effortless transition from welding to grinding modes.

New front air exhaust vents help reduce fogging, and highly adjustable suspension and well-balanced design enhance the well known Speedglas top performance and comfort qualities.

#### Features:

- Exceptionally large, 8" x 4.25" protective visor with 105 degree viewing angle significantly increases user's field of view in all directions.
- Smooth flip-up pivot mechanism allows for effortless one-handed use and quick transition between welding and grinding modes.
- Compatible with all 3M™ Speedglas™ 9100 Auto Darkening Filters (Shade 5, 8, 9-13, and tack mode).
- Includes SideWindows with exclusive Shade 5 filters allow you to see others working around you.
- Meets the mechanical strength requirements of EN 175 level "B" and ANSI Z87.1 – 2010.
- Includes spark deflector, and optional flame-resistant extended ear and neck protection accessory for added protection from welding hazards.
- Front and side air exhaust vents minimize fogging and enhance comfort, particularly during extended use.
- Compatible with most 3M disposable respirators and select 3M reusable respirators.

SKU	Description	UOM	Price
3M0606000SW	Speedglas™ Welding Helmet 9100 FX with SideWindows and head cover (no ADF)	EA	\$318.01
3M06060010SW	Speedglas™ Welding Helmet 9100 FX, with SideWindows Auto-Darkening Filter 9100V Shade 5, 8-13	EA	\$598.43
3M06060020SW	Speedglas™ Welding Helmet 9100 FX with SideWindows Auto-Darkening Filter 9100X Shade 5, 8-13	EA	\$697.10
3M06060030SW	Speedglas™ Welding Helmet 9100 FX with SideWindows Auto-Darkening Filter 9100XX Shade 5, 8-13	EA	\$771.39

### B. 3M™ Speedglas™ Welding Helmets Series 100

3M™ Speedglas™ Welding Helmet Series 100 allows you to take advantage of excellent optical quality and reliable light-to-dark switching at an affordable price. Choose from several highly creative graphic helmet designs - each with a unique personality.

The easy-to-use Speedglas 100 model helmet can be an ideal auto-darkening helmet for the occasional welder. Welders can benefit from the ability to clearly see with their welding protection in place.

#### Features:

- Speedglas 100 welding helmets meet high impact standards of ANSI Z87.1 - 2003 and CSA Z94.3.
- Five adjustable dark shades 8-12 and a light shade of 3.
- Three sensitivity settings.
- Switching speed (light to dark) of <0.1 ms.

SKU	Description	UOM	Price
3M07001231IH	Welding Helmet 100 Ice Hot, 100V Shades 8-12	EA	\$275.25
3M07001231RD	Welding Helmet 100 Razor Dragon, 100V Shades 8-12	EA	\$275.25



**B**

#### WARNING

This product is designed to help protect the wearer's eyes and face from harmful radiation including visible light, ultra-violet radiation (UV), infra-red radiation (IR), sparks and spatter resulting from welding processes. These products must be used only by qualified persons who are properly trained in their use and maintenance. Misuse may result in permanent eye injury and vision loss. Always wear ANSI Z87.1 compliant safety spectacles in addition to any welding helmet. For proper use, see supervisor, or User Instructions or call 3M in U.S.A. 1-800-243-4630. In Canada, call Technical Service at 1-800-267-4414.



by Honeywell

### A. Superglas Pipeliner

Molded from Superglas Plus, this helmet is light and strong. Provides everything pipe welders need in a helmet to be safe and productive under the harshest welding conditions. Impervious to moisture, impact-resistant, will not crack, chip or split. Compact design allows access to areas where there is no room for a standard helmet. Comfortable, functional headgear uses a constant-fit rubber headband for frequent readjustments as pipe welders move about their work. Also available with a ratchet headgear for use where space limitations are not as severe.

SKU	Description	Color	UOM	Price
FIB110	Ratchet headgear	White	EA	\$57.33
FIB110P	Rubber headband	White	EA	\$56.76
FIB1-CP	Pipeliner elastic headgear		EA	\$18.43
FIB1-PS	Neoprene headgear strap		EA	\$1.86

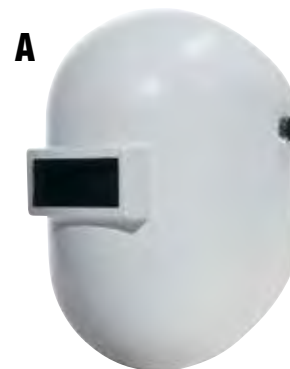

### B. TIGERHOOD® Thermoplastic Welding Helmets

Lightweight Tigerhood helmets are molded from Noryl®, a tough weight-to-strength, heat-resistant thermoplastic. Their universal shell shape combines under-chin and straight-front helmet benefits to increase welder comfort and protection. Choose from telescoping lift front stationary, molded-in or wide vision molded-in glass holder models. Deeply offset, pliable headband fits head contours comfortably. Overhead band with multiple adjustments helps position the glass holder for the best view of the weld and a comfortable working position. Exclusive “free-floating” arms balance and stabilize the helmet while minimizing pressure points.

SKU	Description	UOM	Price
FIB4906	Helmet with Quick-Lok	EA	\$49.24
FIB5906	Helmet with Speedy-Loop	EA	\$48.07
FIB3C	Standard replacement headgear	EA	\$19.54
FIB4000	Quick Lok mounting system	EA	\$17.21
FIB4001	Quick-Lok no-tool cups	EA	\$7.35
FIB4002	Quick-Lok mounting blocks	EA	\$8.88
FIB5000	Speedy-Loop helmet mount	EA	\$18.83
FIB906	Helmet with lift front glassholder	EA	\$53.18
FIB990	Helmet with wide lens	EA	\$43.01



### C. Trident Camo Welding Helmet

Eye-catching, contour and lightweight. Sellstrom’s new Trident™ graphic welding helmets are ideal for all welding applications. Featured with the new patent pending “Quick Release” ratchet headgear suspension allowing the user to adjust size and tighten at the turn of a knob and RELEASE at the pull of a knob. Quality materials and design features insure this helmet perfect for any job. Extended crown provides greater overhead protection. Rigid bib deflects welding spatter. Meets ANSI Z87.1 Standards.

SKU	Description	Color	UOM	Price
SEL41200CA	Trident welding helmet	Camo	EA	\$283.55



### D. Adapter Kits for Welding Shields and Sparkgards

Permit the easy attachment of Welding Shields and Sparkgards with visors to MSA’s slotted caps.

SKU	Description	UOM	Price
MSA485460	Instant release attachment for slotted caps	EA	\$38.36
MSA488525	Welding helmet adapter for slotted caps	EA	\$15.81





3M27110100SW



3M27110110SW  
10SW/20SW/30SW

### A. 3M™ Speedglas™ Welding Helmet 9100 MP with 3M™ Adflo™ PAPR and HE filter

The award-winning 3M™ Adflo™ Powered Air Purifying Respirator is especially designed for you, as a welder. Its slim profile, light weight, and ergonomic design fits into many tight welding spaces. And you can simply add an organic vapor/acid gas OV/AG cartridge to the HE particle filter — and selectively replace either as needed.

The airflow is always a constant nominal rate of approx. 7 CFM (205 liters/minute), regardless of the battery's charge or the particle loading of the filter. The Adflo PAPR, combined with the 3M™ Speedglas™ Welding Helmet 9100 MP's unique air delivery system achieves an OSHA assigned protection factor of 25.

SKU	Description	UOM	Price
3M27110100SW	3M™ Speedglas™ Welding Helmet 9100 MP with 3M™ Adflo™ PAPR, HE filter without welding filter	EA	\$1989.22
3M27110110SW	3M™ Speedglas™ Welding Helmet 9100 MP with 3M™ Adflo™ PAPR, HE filter and 3M™ Speedglas™ Welding Filter 9100V	EA	\$2553.18
3M27110120SW	3M™ Speedglas™ Welding Helmet 9100 MP with 3M™ Adflo™ PAPR, HE filter and 3M™ Speedglas™ Welding Filter 9100X	EA	\$2675.60
3M27110130SW	3M™ Speedglas™ Welding Helmet 9100 MP with 3M™ Adflo™ PAPR, HE filter and 3M™ Speedglas™ Welding Filter 9100X	EA	\$2798.02

### B. 3M™ Speedglas™ Welding Helmet 9100 MP with 3M™ Speedglas™ Fresh-air III Supplied Air Regulator, V-100 cooling valve

For welding environments where supplied air respiratory protection is needed, the 3M™ Speedglas™ Fresh-air III Supplied Air Regulator System can be used with the 3M™ Speedglas™ Welding Helmet 9100 MP. The lightweight, belt-mounted regulator allows you to regulate the airflow from a supplied air source and cool or heat the air entering the headgear by as much as 50°F (28°C), - ideal for extreme temperature work environments.

The Fresh-air III SAR system meets National Institute for Occupational Safety and Health (NIOSH) standards for supplied air respirators, OSHA assigned protection factor of 25 with Speedglas welding helmet 9100 MP, and Freshair III SAR regulator (3M™ Valves V-Series). Meets the requirements of CSA Z94.3 for CSA marked products and the high impact requirements of ANSI Z87.1 - 2010

SKU	Description	UOM	Price
3M27570200SR	3M™ Speedglas™ Welding Helmet 9100 MP with V-100SR cooling valve with Schrader Fitting, without welding filter	EA	\$1281.46
3M27570210SW	3M™ Speedglas™ Welding Helmet 9100 MP with 3M™ Speedglas™ Welding Filter 9100V	EA	\$1580.57
3M27570220SW	3M™ Speedglas™ Welding Helmet 9100 MP with 3M™ Speedglas™ Welding Filter 9100X	EA	\$1694.98
3M27570230SW	3M™ Speedglas™ Welding Helmet 9100 MP with 3M™ Speedglas™ Welding Filter 9100XX	EA	\$1809.36



3M275702

### C. 3M™ Speedglas™ Welding Helmet 9100 MP with 3M™ Speedglas™ Fresh-air III Supplied Air Regulator, V-300 air-regulating valve

SKU	Description	UOM	Price
3M27590210SW	3M™ Speedglas™ Welding Helmet 9100 MP with 3M™ Speedglas™ Welding Filter 9100V	EA	\$1347.51
3M27590220SW	3M™ Speedglas™ Welding Helmet 9100 MP with 3M™ Speedglas™ Welding Filter 9100X	EA	\$1461.91
3M27590230SW	3M™ Speedglas™ Welding Helmet 9100 MP with 3M™ Speedglas™ Welding Filter 9100XX	EA	\$1576.31



3M275902

#### WARNING!



These respirators help reduce exposure to certain airborne contaminants. Before use, the wearer must read and understand the USER Instructions provided as a part of the product packaging. A written respiratory protection program must be implemented meeting all the requirements of OSHA 1910.134 including training, fit testing and medical evaluation. In Canada, CSA standards Z94.4 requirements must be met and/or requirements of the applicable jurisdiction, as appropriate. Misuse may result in sickness or death. For proper use, see packaging instructions, supervisor, or call 3M OH&ESD Technical Service in USA at 1-800-243-4630 and in Canada at 1-800-267-4414.



## 3M™ GVP-Series Powered Air Purifying Respirators

These assemblies are available with a web belt or comfort belt. In addition to the waist belt, the assembly includes power cord, motor blower, battery, charger and flow meter. The system contours to the hip and body for comfort.

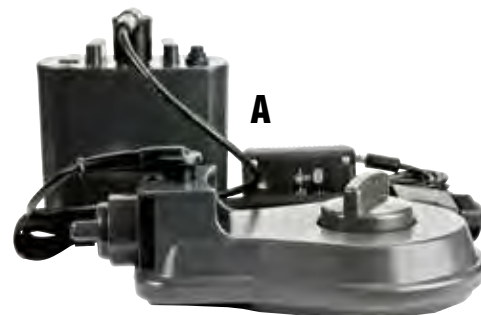

### A. 3M™ GVP-Series PAPR GVP-1

This belt-mounted powered air purifying respirator assembly includes components needed to make a complete PAPR system. Helps provide respiratory protection when combined with 3M™ Headgear and breathing tube.

SKU	Description	UOM	Price
3MGVP-1	GVP-Series PAPR, Standard Belt, NiCd Battery	EA	\$943.00



### B. 3M™ GVP-Series PAPR GVP-1U

Includes the components needed to make a complete 3M™ PAPR System. When combined with the 3M™ Headgear and breathing tube, it provides protection for a wide range of applications.

SKU	Description	UOM	Price
3MGVP1U	GVP-Series PAPR, Urthane Belt, NiCd Battery	EA	\$1018.83



### C. 3M™ GVP-Series PAPR GVP-CB

This belt-mounted powered air purifying respirator assembly includes components needed to make a complete, comfortable PAPR system. Offers high airflow to the worker. Comfort belt is adjustable to fit waists from 26 inches to 54 inches.

SKU	Description	UOM	Price
3MGVP-CB	GVP-Series PAPR, Comfort Belt, NiCd Battery	EA	\$1096.47



### D. 3M™ Cartridges and Filters GVP-Series

SKU	Description	UOM	Price
3MGVP-401	Organic Vapor Cartridge	6/PK	\$406.05
3MGVP-402	Acid Gas Cartridge	6/PK	\$372.36
3MGVP-403	Organic Vapor/Acid Gas Cartridge	6/PK	\$358.38
3MGVP-404	Ammonia Cartridge	6/PK	\$451.61
3MGVP-405	Formaldehyde Cartridge	6/PK	\$447.31
3MGVP-440	HEPA Filter	8/PK	\$326.70
3MGVP-441	Organic Vapor/HE Cartridge	6/PK	\$562.40
3MGVP-442	Acid Gas/HE Cartridge	6/PK	\$556.70
3MGVP-443	Organic vapor/Acid Gas/HEPA Cartridge	6/PK	\$562.40
3MGVP-444	Ammonia/HE Cartridge	6/PK	\$739.16
3MGVP-445	Formaldehyde/HE Cartridge	6/PK	\$646.15

**IMPORTANT:** All 3M™ products shown in this catalogue must be used in accordance with the OSHA regulations and the user instructions, warnings, and limitations accompanying each product.





**A**

### A. 3M™ L-Series Headgear

APF 25 (L-705SG) or APF 1000 (L-901SG/L-905SG) Respiratory Protection, Head Protection, Eye/Face Protection.

SKU	Description	UOM	Price
3ML705	Hard Hat, Speedglas™ Welding Shield, Wideview Faceshield	EA	\$640.55
3ML901SG	Helmet, Wideview Faceshield, Shroud	EA	\$585.31
3ML905SG	Helmet, Speedglas™ Welding Shield, Wideview Faceshield, Shroud	EA	\$711.56

**B**



### B. 3M™ Breathing Tube L-122

This breathing tube is attached to the opening on 3M™ Headgear L-Series to help provide respiratory protection. The lower end of the breathing tube is attached to the air control device.

SKU	Description	UOM	Price
3ML122	Breathing Tube for L-series Facepiece	EA	\$101.99

**C**



### C. 3M™ Full Facepiece 7800S

This is the ultimate reusable full facepiece respirator. The lightweight silicone facepiece enhances the comfortable fit and improves durability. Breathing is easier with the extra-large inhalation and exhalation valves. Double-flange face seal and six adjustable straps on the 7800S help provide a secure fit. Not for use with 3M™ Self-Contained Breathing Apparatus (SCBA) Systems.

SKU	Description	Size	UOM	Price
3M7800S(sm)	Full Facepiece 7800S-S	S	EA	\$394.70
3M7800S(MD)	Full Facepiece 7800S-M	M	EA	\$394.70
3M7800S(lg)	Full Facepiece 7800S-L	L	EA	\$394.70

**D**



### D. 3M™ Combination Dual Airline Back-Mounted Breathing Tube

Used on both the high and low pressure back-mounted combination kits.

SKU	Description	UOM	Price
3MSA2600	Dual airline back-mounted adapter kit	EA	\$160.35

**E**



### E. 3M™ Welders Full Face Shroud

Use with 3M™ Full Facepieces 7000 Series to cover head and shoulders. Leather.

SKU	Description	UOM	Price
3M7993	Welders full face shroud, leather	EA	\$233.22



### A. 3M™ Clip-on Welding Shield

This lightweight, easy to use clip-on welding adapter can be used in conjunction with the 3M™ Full Facepiece 7800S and is approved in all modes of operation as an accessory product. It is compatible with standard 4.5 by 5.25 inch lens. Also can be used with the 3M™ Electronic Lens Assembly 7991/7991-AM. The large viewing area enhances wearer safety.

SKU	Description	UOM	Price
3M7990	Clip-on welding attachment for the 3M™ Full Facepiece 7800S	EA	\$197.21



**B**

### B. 3M™ Electronic Lens Assembly

Auto darkening lens enhances the quality and speed of the welds by allowing the wearer to view the weld with the lens down, unlike traditional passive lenses. Variable shade options (9-12) allows for multiple uses.

SKU	Description	UOM	Price
3M7991	Auto darkening lens for use with 3M™ Clip-on Welding Faceshield Kit	EA	\$618.93

### C. 3M™ Welding Fume Respirators

Maintenance-free particulate respirators are designed for applications such as welding, soldering and other operations where metal fumes are present.

SKU	Description	UOM	Price
3M8212	Particulate welding respirator N95, 3M™ Cool Flow™ Exhalation Valve, welding web, cake-resistant filter media, nose foam, adjustable noseclip, buckle straps and faceseal, 10/BX	BX	\$72.37
3M8512	Particulate welding respirator, N95, 3M™ Cool Flow™ Exhalation Valve, welding web, cake-resistant filter media, nose foam, adjustable noseclip, and buckle straps, 10/BX	BX	\$66.24
3M8214	Particulate respirator N95, 3M™ Cool Flow™ Exhalation Valve faceseal and nuisance level organic vapor relief, 10/BX	BX	\$84.78
3M8514	Particulate respirator N95, 3M™ Cool Flow™ Exhalation Valve nuisance level organic vapor relief, 10/BX	BX	\$75.31
3M8515	Particulate respirator N95, 3M™ Cool Flow™ Exhalation Valve, welding web, adjustable M-Noseclip, and braided headbands, 10/BX	BX	\$32.89



3M8212



3M8214

**C**



3M8515



3M8512



3M8514

**IMPORTANT:** All 3M™ products shown in this catalogue must be used in accordance with the OSHA regulations and the user instructions, warnings, and limitations accompanying each product.







SEL 80211

**A**

### A. Odyssey® II Shade 5 Goggle

The Sellstrom Odyssey® II Shade 5 Goggle provides has an ultra comfortable, soft goggle body for a snug seal and a shade 5 IR Lens. It has indirect vents ports top & bottom protecting against liquids and dust while permitting indirect ventilation. Extra wide peripheral vision fits over prescription eyewear. Meets ANSI Z87.1-2003 Standards and CAN/CSA Z94.3 Standards.

SKU	Description	Lens	UOM	Price
SEL80211	Odyssey II goggle	IR Shade 5	PR	\$17.54
SEL80243	Replacement Lens Odyssey II	IR Shade 5	PR	\$7.76

### B. Plate Goggle

Flexible direct vented goggle body provides maximum air flow and protection against grinding, chipping and cutting operations. UV absorbing polycarbonate lens. High quality, durable green PVC body ensures a proper fit. Supplied with an adjustable 18" elastic headband. Uses standard size filter, cover, impact and magnifier plates. For welding affiliated operations such as medium to heavy torch soldering, brazing and cutting operations. Meets ANSI Z87.1 Standards and is CUL Certified to meet CAN/CSA Z94.3 Standards.

SKU	Description	Lens	UOM	Price
SEL85440	Plate goggle	Shade 4	PR	\$9.54
SEL85450	Plate goggle	Shade 5	PR	\$8.93



SEL85440

**B**



SEL85540

**C**

### C. Lift Front Plate Goggle

Lift front feature allows you to flip up IR lens when not performing welding affiliated operations. Flexible direct vented goggle body provides maximum air flow and protection against grinding, chipping and cutting operations. UV absorbing polycarbonate lens. High quality, durable green PVC body ensures a proper fit. Supplied with an adjustable 18" elastic headband. Uses standard size filter, cover, impact and magnifier plates. For welding affiliated operations such as medium to heavy torch soldering, brazing and cutting operations. Meets ANSI Z87.1 Standards and is CUL Certified to meet CAN/CSA Z94.3 Standards.

SKU	Description	Lens	UOM	Price
SEL85540	Lift front plate goggle	Shade 4	PR	\$10.76
SEL85550	Lift front plate goggle	Shade 5	PR	\$10.76

### D. Lens Cover Goggle

Flexible direct vented goggle body provides maximum air flow and protection against grinding, chipping and cutting operations. UV absorbing polycarbonate lens. High quality, durable green PVC body ensures a proper fit. Supplied with an adjustable 18" elastic headband. Replaceable 50mm lens. For welding affiliated operations such as medium to heavy torch soldering, brazing and cutting operations. Meets ANSI Z87.1 Standards and is CUL Certified to meet CAN/CSA Z94.3 Standards.

SKU	Description	Lens	UOM	Price
SEL85240	Lens cover goggle	Shade 4	PR	\$8.61
SEL85250	Lens cover goggle	Shade 5	PR	\$8.06
SEL04704	Replacement Lens 50mm	Shade 4	PR	\$4.50
SEL04705	Replacement Lens 50mm	Shade 5	PR	\$4.50
SEL04501	Replacement Protective Impact Lens 50mm	Clear	PR	\$8.43



SEL85240

**D**



SEL85350

**E**

### E. Lift Front Lens Cover Goggle

Lift front feature allows you to flip up IR lens when not performing welding affiliated operations. Flexible direct vented goggle body provides maximum air flow and protection against grinding, chipping and cutting operations. UV absorbing polycarbonate lens. High quality, durable green PVC body ensures a proper fit. Supplied with an adjustable 18" elastic headband. Replaceable 50mm lens. For welding affiliated operations such as medium to heavy torch soldering, brazing and cutting operations. Meets ANSI Z87.1 Standards and is CUL Certified to meet CAN/CSA Z94.3 Standards.

SKU	Description	Lens	UOM	Price
SEL85350	Lift front lens cover goggle	Shade 5	PR	\$9.29
SEL04704	Replacement Lens 50mm	Shade 4	PR	\$4.50
SEL04705	Replacement Lens 50mm	Shade 5	PR	\$4.50
SEL04501	Replacement Protective Impact lens 50mm	Clear	PR	\$8.43

### A. Eye Cup Goggle

Extremely lightweight. Provides protection against grinding, chipping and cutting operations. UV absorbing polycarbonate lens. High quality, durable green PVC body ensures a proper fit. Supplied with an adjustable 18" elastic headband. Replaceable 50mm lens. For welding affiliated operations such as medium to heavy torch soldering, brazing and cutting operations. Meets ANSI Z87.1 Standards and is CUL Certified to meet CAN/CSA Z94.3 Standards.

SKU	Description	Lens	UOM	Price
SEL85110	Eye cup goggle	Clear	PR	\$5.20
SEL85140	Eye cup goggle	Shade 4	PR	\$6.02
SEL85150	Eye cup goggle	Shade 5	PR	\$6.21
SEL04704	Replacement Lens 50mm	Shade 4	PR	\$4.50
SEL04705	Replacement Lens 50mm	Shade 5	PR	\$4.50
SEL04501	Replacement Protective Impact lens 50mm	Clear	PR	\$8.43



SEL85140



USS90202

### B. InfraSpec

Constructed from impact modified nylon, the InfraSpec wrap-around design is lightweight and durable with temples intended to hug the head and adjustable nose pads to insure a secure fit. The flip-up is a simple, extremely functional mechanism that can be raised and lowered with a single motion. The low profile, impact resistant, optical insert is designed to be worn in conjunction with prescription or non prescription lenses, attaching into the frame behind the outer infrared polycarbonate lens. All InfraSpec's provide 99.9% UV protection and a scratch resistant coating to prolong the life of the lens.

SKU	Description	Lens	UOM	Price
USS90202	InfraSpec flip-up glasses	Green IR shade 2.0	PR	\$10.49
USS90203	InfraSpec flip-up glasses	Green IR shade 3.0	PR	\$10.49
USS90205	InfraSpec flip-up glasses	Green IR shade 5.0	PR	\$10.95

### C. Supervisor Series Welding Curtains

Specially designed to allow a safer work environment for welding supervisor, co-worker and passerby. Available in top grade heavy duty vinyl or duck that absorbs dangerous ultraviolet radiation from high amperage welding arcs while allowing excellent observation of activities. Sets up in minutes and comes complete with hardware.

Warning: Curtains and Screens are not to be used as a replacement for a welding helmet or filter plate, but as transmission protection for casual observation

SKU	Description	UOM	Price
SEL97310-1	6' x6' Orange 14 mil. transparent vinyl welding curtain	EA	\$69.41
SEL97310-2	6' x6' Yellow 14 mil. transparent vinyl welding curtain	EA	\$69.41
SEL97310-3	6' x6' Green 14 mil. transparent vinyl welding curtain	EA	\$69.41
SEL97310-4	6' x6' Blue 14 mil. transparent vinyl welding curtain	EA	\$69.41
SEL97310-7	6' x6' Duck welding curtain	EA	\$76.34
SEL97230	Adj. welding curtain frame. can be made into 5'x5', 5'x6', 6'x4' & 6'x6'	EA	\$260.27



### D. Light/Medium Weight Fiberglass Fabric

Withstands a maximum temperature of 1100°F. Woven, non-flammable, asbestos-free fiberglass fabric suitable for lagging, coating and as a curtain for spark protection in welding & cutting.

SKU	Description	Size	UOM	Price
LEW2025-9383	17 oz medium weight fiberglass fabric	5' x 50 yards	EA	\$497.22
LEW9383HI	18 oz heat treated fiberglass fabric 1,000 degree	5' x 50 yards	EA	\$406.28
LEW1800HTO	High temperature silica fabric	36" x 50 yards	EA	\$990.55



by Honeywell

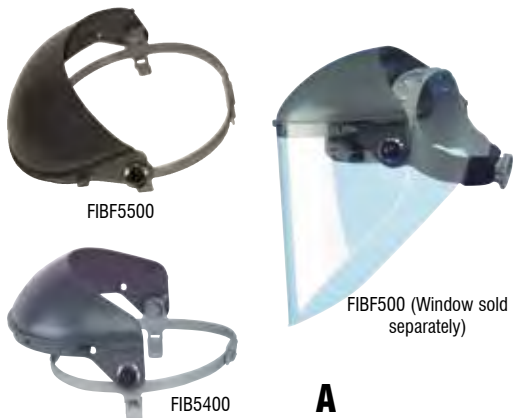

FIBF5500

FIBF5400

FIBF500 (Window sold separately)

**A**



FIB4178

### A. Fibre-Metal Faceshields

Model F-300 is for light duty, general purpose face protection. Exceptionally lightweight and comfortable. Fits easily over today's spectacles with space for air circulation to prevent fogging. Accommodates a 4118 standard size (11-1/2" x 8") window. Model F-400 has a deep crown protector and wider windows for extended face protection. Deeper 4" crown protector extends protection without increasing weight. Incorporates wide-vision (17" x 8") wraparound windows and screens which provide 40% more protective area than standard size faceshields. Fits easily over required spectacles or respirators. Available with choice of three protective cap mounting mechanisms. High Performance protective faceshields can be equipped with model 5000 Speedy-Loop for easy on/off mounting on protective caps. Patented, adjustable loop fits Fibre-Metal caps and most competitive brands; model 4000 Quick-Lok cups for mounting on Fibre-Metal Caps equipped with Quick-Lok blocks for more permanent mounting.

SKU	Description	UOM	Price
FIBF300	Faceshield headband ratchet w/3" crown	EA	\$15.31
FIBF400	Faceshield bracket w/ratchet headgear	EA	\$18.78
FIBF500	Faceshield headgear, 7" crown	EA	\$22.60
FIBF4400	Faceshield bracket w/quick-lok	EA	\$10.92
FIBF4500	Faceshield bracket w/quick-lok caps	EA	\$18.91
FIBF5400	Faceshield bracket w/speedy loop	EA	\$16.69
FIBF5500	Faceshield bracket w/speedy loop mounts	EA	\$20.09

### Fibre-Metal Shaded Replacement Visors

These top quality faceshields feature a wide view window is made of injection molded propionate, superior to cut-acetate in every significant performance characteristic. Pre-shaped at factory for ease of attachment to crown protectors. Fits FIBF300, FIBF400 and FIBF500.

SKU	Description	UOM	Price
FIB4118DRK	Green replacement visors 8" X 11 1/4" fits FIBF300 series	EA	\$5.27
FIB4178DGR	Green replacement visors 8" x 16.5"x .060 fits FIBF400 and FIBF500 series	EA	\$5.95
FIB4178IR/UV	Shade 5 replacement visors 8" x 16.5"x .060 fits FIBF400 and FIBF500 series	EA	\$16.66
FIB4199DRK	Green replacement visors 9 3/4" x 19" fits FIBF400 and FIBF500 series	EA	\$9.61
FIB4199IR/UV	Shade 5 replacement visors 9 3/4" x 19" fits FIBF400 and FIBF500 series	EA	\$20.65

### B. Cap Peak Mounted Faceshields with Shaded Replacement Visors

Lightweight, dielectric faceshield protective cap mounting bracket mounts on the front peak of the cap. Dual channel mounting system uses one channel to anchor the bracket to the cap while the other channel holds the window so it can lock into the work position and pivot up and out of the way when not needed. The locked channels form a positive seal to keep debris from filtering between the cap and faceshield. Molded from strong, heat-resistant Noryl, ideal for extended outdoor use.

SKU	Description	UOM	Price
FIBFM70	Faceshield, cap style	EA	\$10.92
FIBFM71	Faceshield, full brim style	EA	\$10.92
FIB4178	Clear replacement visors 8" x 16.5"x .060	EA	\$5.71
FIB4178DGR	Green replacement visors 8" x 16.5"x .060	EA	\$5.95
FIB4178IR/UV	Shade 5 replacement visors 8" x 16.5"x .060	EA	\$16.66



**B**

**C**

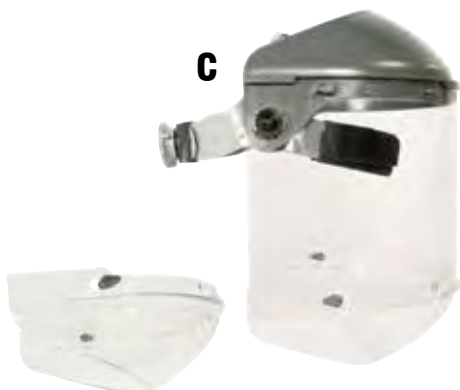

### C. Dual Crown Faceshield with Chin Guard

North is pleased to introduce our new Fibre-Metal brand clear chin guard for all dual crown faceshields. This new clear poly carbonate chin guard will provide our customers with an even better option for cutting and grinding applications by increasing their field of vision.

SKU	Description	Type	UOM	Price
FIBFM5400DC	Dual crown faceshield with chin guard	Speedy Mounting Loop	EA	\$31.70
FIBFM4400DC	Dual crown faceshield with chin guard	4001 Quick Lok Caps	EA	\$30.67
FIBFM400DC	Dual crown faceshield with chin guard	Ratchet Gear	EA	\$34.29
FIBFM3400CGC	Chin gurad clear		EA	\$6.67





### A. Sellstrom® DP4™ Multi-Purpose Faceshield

The new DP4 faceshield combines a clear anti-fog window with a flip-down IR window, providing uninterrupted protection for grinding, cutting, and brazing operations. The shield curves naturally to fit facial contours; ensuring reliable protection from splash, particles, and flying debris. Ratchet headgear suspension allows user to adjust size and tighten at the turn of a knob. Rugged, polycarbonate shield is impact and splash resistant. Meets ANSI Z87.1 standards and is CUL-certified to meet CAN/CSA-Z94.3 standards.

SKU	Description	Lens	UOM	Price
SEL32010	Multi-purpose faceshield	Clear	EA	\$34.14
SEL32151	Multi-purpose faceshield w/5 IR flip up window	Clear	EA	\$50.07
SEL32155	Replacement 5 IR flip up window	5 IR	EA	\$16.23
SEL32130	Replacement faceshield lens	Clear	EA	\$27.78



### B. Portable HEPA Welding Fume Extractors

Air Systems' Portable Fume Extractor is used mainly for source capture of welding smoke and fumes. Different filter combinations can make the Portable Fume Extractor unit very versatile and cost effective for the job required. The Portable Fume Extractor series operates at less than 80dba. A non-metallic fume hood is placed on the 360° rotating adjustable arm and is supplied with an adjustable damper to control air flow velocity at the capture site. The contaminated air is drawn in through the arm or central duct; clean filtered air is exhausted through the sides and bottom of the cabinet.

SKU	Description	UOM	Price
ASIPFE-750	The Fume-Air 750	EA	\$6097.02
ASIPFE2412HF	HEPA filter for Fume-Air 750 24" x 24 x 11-1/2"	EA	\$514.29
ASIPFE2424PF	Prefilter pad Fume-Air 750 24"x 24" x 1" 10/PK	PK	\$91.14
ASIPFE-230	The Fume-Air™ 230	EA	\$2988.09

### C. LeadCheck™ Swabs

Easy to use, disposable LeadCheck Swabs will work on any surface, instantly turning bright pink when lead is present. Each swab is ready to use. There are no hidden steps or lengthy procedures. LeadCheck Swabs are odorless, disposable and non-staining. The entire test procedure is so convenient that it can be performed anywhere in 30 seconds. There's even a test confirmation card to verify test results. This product has an indefinite shelf life.

SKU	Description	UOM	Price
LEADCHK	LeadCheck swabs	8/Kit	\$25.90



### D. ChromateCheck™ Swabs

ChromateCheck Swabs are an instant field test for the detection of hexavalent chromium ions also called chrome (VI) on any surface. When ChromateCheck Swabs come in contact with hexavalent chromium the swab tip turns a pink/purple color. The intensity of the color development is directly related to hexavalent chromium content. Each kit contains 8 swabs and instruction sheet with color guide.

SKU	Description	UOM	Price
LEADCHRCHK	ChromateCheck Swabs	8/Kit	\$44.37



### A. Shoulder Split Cowhide

Shoulder split cowhide provides excellent protection in high heat welding conditions at an affordable price. 14" length protects hands and arms from sparks and spatter. Welting fingers to protect seams from sparks, wing thumb for a natural fit and cotton lining keeps hands cool.

SKU	Description	Size	UOM	Price
WCHE9010L	Welding Glove Shoulder Split Cowhide, Gray	L	DZ	\$69.91

### B. Shoulder Split Cowhide

Shoulder split cowhide provides excellent protection in high heat welding conditions at an affordable price. 14" length protects hands and arms from sparks and spatter. Welting fingers to protect seams from sparks, wing thumb for a natural fit and cotton lining keeps hands cool.

SKU	Description	Size	UOM	Price
WCHE9011L	Welding Glove Shoulder Split Cowhide, Russet	L	DZ	\$87.68



### C. Premium Side Split Cowhide

Premium side split cowhide provides the most durable protection in high heat welding conditions. 14" length protects hands and arms from sparks and spatter. Welting fingers and Kevlar® thread protect seams from sparks, wing thumb for a natural fit and cotton lining keeps hands cool.

SKU	Description	Size	UOM	Price
WCHE9030L	Welding Gloves Premium Side Split Cowhide	L	DZ	\$109.75

### D. Insulated Premium Side Split Cowhide - Dbl Reinforced Thumb

Premium side split cowhide provides the most durable protection in high heat welding conditions. 14" length protects hands and arms from sparks and spatter. Additional layer of foam on palm and back of hand provides added heat insulation. Double reinforced thumb combines thumb strap with an added patch on thumb saddle to protect high stress area. Double reinforced wing thumb provides a natural fit and reduces abrasion. Welting fingers and Kevlar® thread protect seams from sparks.

SKU	Description	Size	UOM	Price
WCHE9051	Welding Gloves Insulated Premium Side Split Cowhide, Reinf Thumb	M-XL	DZ	\$128.50





### A. Heavyweight Top Grain Cowhide - MIG

Heavyweight grain cowhide glove provides a sturdy glove for all-around MIG welding. Unlined for additional dexterity. 4" cuff protects hands and lower arms from burns. Kevlar® thread protects seams from sparks. Wing thumb and seamless forefinger for increased dexterity.

SKU	Description	Size	UOM	Price
WCHE6010	Welding Gloves Heavyweight Top Grain Cowhide, MIG	S-XL	DZ	\$112.29



**B**

### B. Insulated Top Grain Pigskin - MIG

Grain pigskin glove provides a pliable and sturdy glove for MIG welding. Additional foam lining on back of hand protects against heat while reinforced straight thumb minimizes abrasion. 4" cuff protects hands and lower arms from burns. Kevlar® thread protects seams from sparks. Pigskin is ideal for wet and oily conditions.

SKU	Description	Size	UOM	Price
WCHE6020	Welding Gloves Insulated Top Grain Pigskin, MIG	M-L	PR	\$13.02



### C. Premium Grain Cow MIG/TIG Welder's Gloves

Top of the line welder's gloves feature premium grade cowhide leather sewn with Kevlar® thread for improved durability. 4" split leather gauntlet cuff protects wrist and forearm.

SKU	Description	Size	UOM	Price
MSG8130	Premium grain leather MIG/TIG welding glove	M-L	DZ	\$95.71
MSG8130XL	Premium grain leather MIG/TIG welding glove	XL	DZ	\$98.84
MSG81302XL	Premium grain leather MIG/TIG welding glove	2X	DZ	\$103.68



**C**



**D**



### D. FR Treated Cotton Sateen Jacket 30"

30" length, 9 oz. green durable FR treated cotton sateen jacket with snap closure on front and wrist, inside left breast pocket, set-in sleeve and 3" lay down collar.

SKU	Colors	Sizes							UOM
STGGS16750	Green	S	M	L	XL	2X	3X	4X	EA
<b>Price</b>		\$27.02	\$27.02	\$27.02	\$27.02	\$29.72	\$29.72	\$32.42	



# Ergonomics





### A. ProFlex® 100 Economy Back Support

Economy Back Support: Rubber track webbing helps keep support in position. Features include adjustable, detachable suspenders, non-conductive polypropylene stays, Stretchable bias binding with zig-zag stitching and 280D spandex body material.

SKU	Description	Color	Size	UOM	Price
ERG100PL	Economy back support	Black	XS-L	EA	\$13.88
ERG100PLXL	Economy back support	Black	XL	EA	\$13.88
ERG100PLXXL	Economy back support	Black	2XL	EA	\$13.88
ERG100PLXXXL	Economy back support	Black	3XL	EA	\$13.88
ERG100PLXXXX	Economy back support	Black	4XL	EA	\$13.88



### B. ProFlex® 1100SF Standard w/Sticky Fingers® Back Support

Standard Back Support features patented non-conductive Sticky Fingers® stays, Adjustable, detachable suspenders, patented power panel positioners™, durable 280D spandex body material and stretchable bias binding with zig-zag stitching.

SKU	Description	Color	Size	UOM	Price
ERG1100SFXS	Standard back support	Black	XS	EA	\$26.44
ERG1100SFS	Standard back support	Black	S	EA	\$26.44
ERG1100SFM	Standard back support	Black	M	EA	\$26.44
ERG1100SFL	Standard back support	Black	L	EA	\$26.44
ERG1100SFXL	Standard back support	Black	XL	EA	\$26.44
ERG1100SFXXL	Standard back support	Black	2XL	EA	\$26.44
ERG1100SF3X	Standard back support	Black	3XL	EA	\$26.44
ERG1100SF4X	Standard back support	Black	4XL	EA	\$26.44

### C. ProFlex® 1650 Economy Elastic Back Support

The ProFlex® Economy Elastic Back Support has an elastic 7.5-inch body for extra firm support. It also features a 5" (12.7 cm) single strap closure, non-conductive polypropylene stays, rubber track webbing, stretchable bias binding with zig-zag stitching and adjustable, detachable suspenders.

SKU	Description	Color	Size	UOM	Price
ERG1650S	ProFlex economy elastic back support	Black	S	EA	\$11.79
ERG1650M	ProFlex economy elastic back support	Black	M	EA	\$11.79
ERG1650L	ProFlex economy elastic back support	Black	L	EA	\$11.79
ERG1650XL	ProFlex economy elastic back support	Black	XL	EA	\$11.79
ERG1650XXL	ProFlex economy elastic back support	Black	2XL	EA	\$11.79



### D. ProFlex® 1500 Weight Lifters Back Support

Rigid foam composition back support with a durable fabric body. Horizontal lumbar pad fills the gap in the back's natural curve for added support and comfort throughout longer periods of wear. The contoured design hugs the body for an exact comfortable fit. Ideal for over-the-head lifting.

SKU	Description	Color	Size	UOM	Price
ERG1500S	Weight Lifters back support	Black	S	EA	\$29.86
ERG1500M	Weight Lifters back support	Black	M	EA	\$29.86
ERG1500L	Weight Lifters back support	Black	L	EA	\$29.86
ERG1500XL	Weight Lifters back support	Black	XL	EA	\$29.86
ERG1500XXL	Weight Lifters back support	Black	2XL	EA	\$29.86



### A. OccuMitts Support Gloves

Snug, lightweight stretch gloves act like support hose to help promote proper wrist position, soothe irritation, stimulate circulation and keep hands flexible. OccuMitts can be worn under work gloves or alone. OccuMitts are ideal for computer users, garment workers, electronics assemblers, food processors, meat cutters, carpenters, painters, musicians, mail sorters, mechanics, dentists, dental hygienists, cashiers, case cutters, hair stylists, pet groomers, garment workers, gardeners, people with arthritis and more. Ideal for nighttime wear to help keep hands warm and flexible the next day.

SKU	Description	Measurements	Color	Size	UOM	Price
OCC450BXS	OccuMitts support gloves	up to 2.5"	XS	Beige	PR	\$6.91
OCC450B	OccuMitts support gloves	2.5 - 3.0"	S	Beige	PR	\$6.91
OCC450BM	OccuMitts support gloves	3.0 - 3.5"	M	Beige	PR	\$6.91
OCC450BL	OccuMitts support gloves	3.5 - 4.0"	L	Beige	PR	\$6.91
OCC450BXL	OccuMitts support gloves	over 4.0"	XL	Beige	PR	\$6.91
OCC450N-XS	OccuMitts support gloves	up to 2.5"	XS	Navy	PR	\$6.91
OCC450N-S	OccuMitts support gloves	2.5 - 3.0"	S	Navy	PR	\$6.91
OCC450N-M	OccuMitts support gloves	3.0 - 3.5"	M	Navy	PR	\$6.91
OCC450N-L	OccuMitts support gloves	3.5 - 4.0"	L	Navy	PR	\$6.91
OCC450N-XL	OccuMitts support gloves	over 4.0"	XL	Navy	PR	\$6.91

### B. ProFlex® 4000 Wrist Support

World's leading wrist support. Limits downward wrist movements. Includes patented open-center stay™ to reduce pressure on median nerve. Durable fabric holds up to the toughest work environments. Fully-adjustable for an exact fit and comfortable wear.

SKU	Description	Color	Size	UOM	Price
ERG4000SR	Wrist support - single strap	Black	S right	EA	\$10.66
ERG4000MR	Wrist support - single strap	Black	M right	EA	\$10.66
ERG4000LR	Wrist support - single strap	Black	L right	EA	\$10.66
ERG4000XLR	Wrist support - single strap	Black	XL right	EA	\$10.66
ERG4000SL	Wrist support - single strap	Black	S left	EA	\$10.66
ERG4000ML	Wrist support - single strap	Black	M left	EA	\$10.66
ERG4000LL	Wrist support - single strap	Black	L left	EA	\$10.66
ERG4000XLL	Wrist support - single strap	Black	XL left	EA	\$10.66

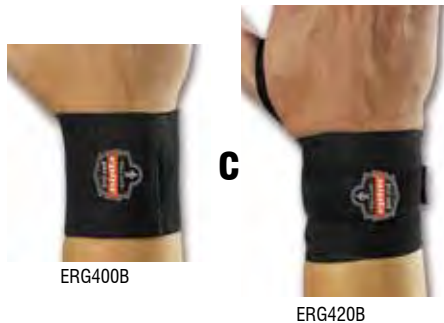

### C. Ergodyne® 400 & 420 Thumb Loop Wrist Wrap

Thumb loop design secures around the thumb and wrist for maximum support and comfort. Durable woven elastic improves support and wearability. Hook-and-loop closure quickly adjusts to the desired tension and exact fit. Available in two sizes: S/M and L/XL. Ambidextrous.

SKU	Description	Color	Size	UOM	Price
ERG400B	Wrist wrap universal	Black		EA	\$2.03
ERG420BS/M	Wrist wrap - thumb loop	Black	S/M	EA	\$2.35
ERG420BL/XL	Wrist wrap - thumb loop	Black	L/XL	EA	\$2.35
ERG420TS/M	Wrist wrap - thumb loop	Tan	S/M	EA	\$2.35
ERG420TL/XL	Wrist wrap - thumb loop	Tan	L/XL	EA	\$2.35

### D. ProFlex® 4010 Wrist Support

Limits upward and downward wrist movements. Includes patented open-center stay to reduce pressure on median nerve. Fully-adjustable for an exact fit and comfortable wear. Four sizes available: S, M, L, XL.

SKU	Description	Color	Size	UOM	Price
ERG4010SR	Wrist support - dual strap	Black	S right	EA	\$14.07
ERG4010MR	Wrist support - dual strap	Black	M right	EA	\$14.07
ERG4010LR	Wrist support - dual strap	Black	L right	EA	\$14.07
ERG4010XLR	Wrist support - dual strap	Black	XL right	EA	\$14.07
ERG4010SL	Wrist support - dual strap	Black	S left	EA	\$14.07
ERG4010ML	Wrist support - dual strap	Black	M left	EA	\$14.07
ERG4010LL	Wrist support - dual strap	Black	L left	EA	\$14.07
ERG4010XLL	Wrist support - dual strap	Black	XL left	EA	\$14.07





### A. ProFlex® 670 Ambidextrous Wrist Support

Ambidextrous Single Strap Wrist Support: Supplemental support to help relieve stress associated with repetitive strain and overuse injuries.

SKU	Description	Color	Size	UOM	Price
ERG670S	Neoprene Wrist support, Reversible hook & loop strap	Black	S	EA	\$6.75
ERG670M	Neoprene Wrist support, Reversible hook & loop strap	Black	M	EA	\$6.75
ERG670L	Neoprene Wrist support, Reversible hook & loop strap	Black	L	EA	\$6.75
ERG670XL	Neoprene Wrist support, Reversible hook & loop strap	Black	XL	EA	\$6.75



A



B

### B. ProFlex® 675 Ambidextrous Wrist Support

Ambidextrous Double Strap Wrist Support: Supplemental support to help relieve stress associated with repetitive strain and overuse injuries.

SKU	Description	Color	Size	UOM	Price
ERG675S	Neoprene Wrist support, two reversible hook & loop straps	Black	S	EA	\$8.70
ERG675M	Neoprene Wrist support, two reversible hook & loop straps	Black	M	EA	\$8.70
ERG675L	Neoprene Wrist support, two reversible hook & loop straps	Black	L	EA	\$8.70
ERG675XL	Neoprene Wrist support, two reversible hook & loop straps	Black	XL	EA	\$8.70

### C. Universal Wrist Wrap

Neoprene construction for warmth and compression. Malleable aluminum palmer stay. Contact closure. Ideal for Carpal Tunnel Syndrome and immobilization of the wrist.

SKU	Description	Size	UOM	Price
AC82481	Universal wrist wrap, left	Universal	EA	\$10.77
AC82480	Universal wrist wrap, right	Universal	EA	\$10.77



C

PROCARE



D

### D. Wrist Wrap

Specially designed neoprene wrist wrap offers improved compressive support for weak or injured wrist. Adjustable design provides a secure fit. Fits right or left.

SKU	Description	UOM	Price
AC82300	Wrist wrap black	EA	\$6.30



### A. Wrist Support with Metal Stay Universal Black

Universally sized wrist support can be worn on either left or right wrist. Constructed with a reshaped 6" stay and black duo-tension elastic. Tension strap adds stability and support. No impairment of flexibility or dexterity. Stockinette lining.

SKU	Description	Size	UOM	Price
57381385	Wrist Support with metal stay	Universal	EA	\$13.03

### B. Wrist Wrap- 3"

Wraparound style wrist wrap provides warmth and compression. Easy to apply.

SKU	Description	UOM	Price
57381311-00	Wrist wrap, 3"	EA	\$2.65

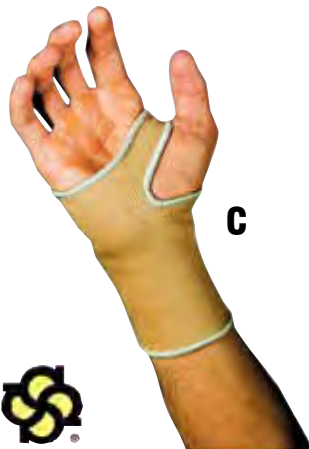

### C. 6" Slip-on Wrist Compression

This slip-on wrist compression features thumb hole and beige, knitted cotton elastic. Fits either hand.

SKU	Description	Measurements	Size	UOM	Price
57381361S	6" Slip-on wrist compression	5 1/2 - 6 1/2"	S	EA	\$7.10
57381361M	6" Slip-on wrist compression	6.75 - 7.5"	M	EA	\$7.10
57381361L	6" Slip-on wrist compression	7.75 - 8.5"	L	EA	\$7.10
57381361XL	6" Slip-on wrist compression	8 3/4 - 10"	XL	EA	\$7.10

### D. Neoprene Thumb Wrist Support

Neoprene thumb and wrist support helps keep hand and muscles warm. Protects against chafing. Great in cold environments such as meat and poultry processing.

SKU	Description	Measurements	Color	Size	UOM	Price
OCC400S	Thumb wrist support	6.5 - 7.5"	Navy	S	EA	\$11.00
OCC400M	Thumb wrist support	7.5 - 8.5"	Navy	M	EA	\$11.00
OCC400L	Thumb wrist support	8.5 - 9.5"	Navy	L	EA	\$11.00
OCC400XL	Thumb wrist support	9.5 - 10.5"	Navy	XL	EA	\$10.00

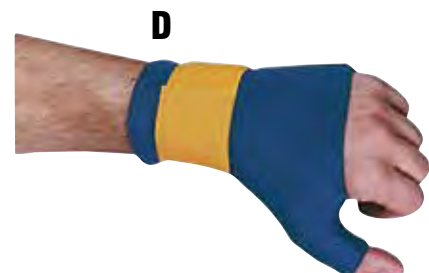

**OccuNomix**  
International LLC

### A. Neoprene Tennis Elbow Brace with Pad & Strap

Neoprene Elbow Support helps alleviate pain due to tennis elbow (lateral epicondylitis), supinator muscle strain and tendonitis. Applies pressure below the elbow while maintaining a full range of motion. Epicondyle pad focuses effective, gentle pressure. Contoured neoprene construction for healing warmth. Hook-and-loop compression strap. Wear only during activity.

SKU	Description	Size	UOM	Price
TAMT525PD-S	Tennis elbow brace with pad & strap	S	EA	\$19.73
TAMT525PD-M	Tennis elbow brace with pad & strap	M	EA	\$19.73
TAMT525PD-L	Tennis elbow brace with pad & strap	L	EA	\$19.73
TAMT525PD-XL	Tennis elbow brace with pad & strap	XL	EA	\$19.73



A

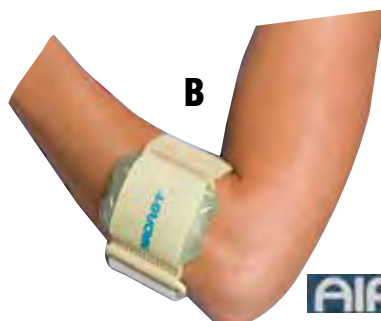

B

AIRCAST

### B. Pneumatic Armband

A single, pre-inflated aircell, concentrates compression on the extensor muscle, not around the arm – providing more support, less constriction. Universal fit. Indications: tennis elbow; golfer's elbow (epicondylitis)

SKU	Description*	Color	Dimensions	UOM	Price
AIR05-A	Pneumatic Armband	Beige	8 - 14"	EA	\$16.04

### C. Tennis Elbow Strap With Unifoam

Provides compression to support stretched or weakened muscles and can be used for minor muscle stains or sprains of the elbow. 3" wide foam laminated to pressure sensitive fabric engages with hook tab. Features elastic insert for desired compression.

SKU	Description	UOM	Price
57381975	Tennis elbow strap w/unifoam	EA	\$3.48

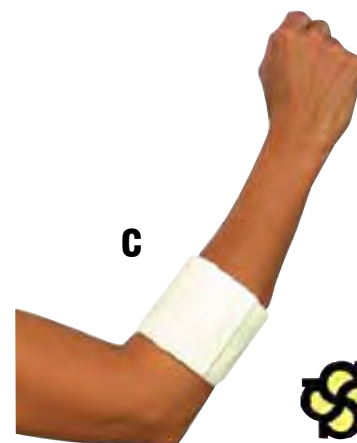

C



D



### D. Neoprene Tennis Elbow Strap

Blue 2" wide neoprene strap with loop-lock closure. Provides local pressure to muscle of the forearm.

SKU	Description*	Color	Size	UOM	Price
57389032-00	Neoprene tennis elbow strap	Blue	Universal	EA	\$5.35

### E. 2" Vinyl Tennis Elbow Brace

2" wide leatherette vinyl wrap and soft nylon tricot for comfort. Loop lock provides easy application and tension adjustment. One size fits all.

SKU	Description	Size	UOM	Price
57381960-00	2" Vinyl tennis elbow brace	Universal	EA	\$4.00



E







**A**



### A. 2" Plush Tennis Elbow Support

Royal blue plush fabric on both sides; accepts hook closure anywhere. Easy to adjust with loop-lock ring. 2" wide.

SKU	Description	Size	UOM	Price
57381969-00	2" Plush tennis elbow support	Universal	EA	\$4.95

### B. Slip-on Elbow Support

This slip-on elbow support features varying degrees of tension for proper fit. Provides compression to support stretched or weakened muscles and can be used for minor muscle stains or sprains of the elbow. Features an 8" length.

SKU	Description	Measurements	Size	UOM	Price
57381953-01	Slip-on elbow support	9 - 10"	S	EA	\$7.72
57381953-02	Slip-on elbow support	10 - 12"	M	EA	\$7.72
57381953-03	Slip-on elbow support	12 - 14"	L	EA	\$7.72
57381953-04	Slip-on elbow support	13 - 16"	XL	EA	\$7.72



**B**



**C**

### C. Elbow Sleeve

Neoprene sleeve provides maximum warmth and comfort without roll or ride-up. Offers support and relief to elbow joint, muscles and tendons. 8.5" length. Ideal for mild support and compression of the elbow.

SKU	Description	Circ.	Size	UOM	Price
AC82317	Elbow sleeve	12" - 14"	L	EA	\$11.16
AC82318	Elbow sleeve	14" - 16"	XL	EA	\$11.16



### D. Tennis Elbow Wrap

Neoprene construction with full circumferential sewn-on vinyl strap for firm counter force support. Ideal for medial epicondylitis (golfer's elbow) and lateral epicondylitis (Tennis elbow).

SKU	Description	Size	UOM	Price
AC82320	Tennis elbow wrap	S/M	EA	\$7.63
AC82321	Tennis elbow wrap	L/XL	EA	\$8.09

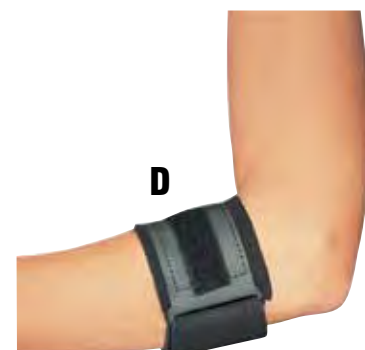

**D**

### A. Ergodyne® 615 Knee Sleeve with Anterior Pad and Open Patella

The contoured design of Ergodyne sleeves conforms to the body's natural shape. Neoprene four-way stretch fabric provides uniform support and warmth. All sleeves are ambidextrous.

SKU	Description	Color	Size	UOM	Price
ERG615S	Knee sleeve, neoprene	Black	S	EA	\$11.31
ERG615M	Knee sleeve, neoprene	Black	M	EA	\$11.31
ERG615L	Knee sleeve, neoprene	Black	L	EA	\$11.31
ERG615XL	Knee sleeve, neoprene	Black	XL	EA	\$11.31
ERG615XXL	Knee sleeve, neoprene	Black	2XL	EA	\$11.31



### B. 11" Slip-on Knee Compression

Beige slip-on knitted elastic provides moderate compression for swelling, weak knees and moderate knee injuries. 11" length with knitted taper in back

SKU	Description	Measurements	Size	UOM	Price
57383611S	11" Slip-on knee compression	12 - 14"	S	EA	\$10.57
57383611M	11" Slip-on knee compression	14.5 - 17"	M	EA	\$10.57
57383611L	11" Slip-on knee compression	17.5 - 20"	L	EA	\$10.57
57383611XL	11" Slip-on knee compression	20.5 - 24"	XL	EA	\$10.57



### C. Sport Aid Ankle Compression

Beige, knitted elastic provides intermediate compression with open toe and heel. Knitted tapered for contour fit.

SKU	Description	Measurements	Size	UOM	Price
57381400S	Sport aid ankle compression	7 - 8"	S	EA	\$7.63
57381400M	Sport aid ankle compression	8 1/4 - 9"	M	EA	\$7.63
57381400L	Sport aid ankle compression	9 1/4 - 10"	L	EA	\$7.63
57381400XL	Sport aid ankle compression	10 1/4 - 11 1/4"	XL	EA	\$7.63

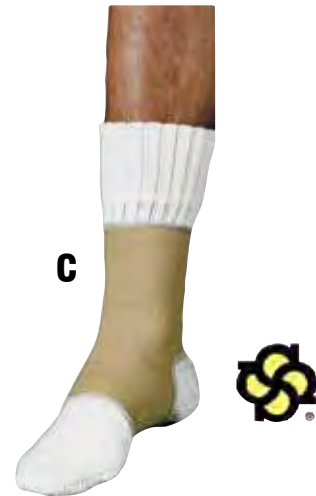

### D. Air-Stirrup® Ankle Brace

Anatomically designed semi-rigid shells lined with the patented Duplex™ aircell system for support and graduated compression during ambulation. The compression promotes efficient edema reduction in addition to helping accelerate rehabilitation from ankle sprains. Indications: Acute injury; Post-op; Ankle sprains grade I, II, III; Chronic instability.

SKU	Description	Brace Length	Ankle	Size	UOM	Price
AIR02-A-L	Air-Stirrup ankle brace	10.5"	Left	L	EA	\$45.37
AIR02-A-R	Air-Stirrup ankle brace	10.5"	Right	L	EA	\$45.37

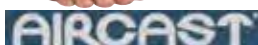



### A. ProFlex® 300 Rounded Cap

Rounded cap allows for swiveling and pivoting during continuous on-the-ground jobs. Tough-as-nails 840 denier nylon fabric stands up to any job. 1/2" neoprene padding provides firm, consistent support without bottoming out. Biomechanically-designed with contoured side cuts for greater knee motion and comfortable fit. Longer design offers maximum surface coverage. Woven elastic straps adjust to an exact fit and improve wearability and comfort. Adjustable buckle easily fastens for a comfortable, exact fit keeps free of dust and grime. Wipes clean with damp cloth. One size adjusts to exact fit. Sold in pairs. Buckle or hook and loop closure.

SKU	Description	Color	Closure	UOM	Price
ERG300	Rounded cap knee pad	Black w/gray cap	Buckle	PR	\$20.75
ERG300HL	Rounded cap knee pad	Black w/gray cap	Hook & loop	PR	\$19.77

### B. ProFlex® 325 Non-Marring Kneepads

This non-marring cap protects delicate work surfaces, such as wood floors. Tough-as-nails 840 denier nylon fabric stands up to any job. 1/2" EVA padding provides firm, consistent support without bottoming out. Biomechanically-designed with contoured side cuts for greater knee motion and comfortable fit. Longer design offers maximum surface coverage. Woven elastic straps adjust to an exact fit and improve wearability and comfort. Adjustable buckle easily fastens for a comfortable, exact fit keeps free of dust and grime. Wipes clean with damp cloth. One size adjusts to exact fit.

SKU	Description	Color	Closure	UOM	Price
ERG325	Non-marring knee pads	Black w/tan cap	Buckle	PR	\$22.37
ERG325HL	Non-marring knee pads	Black w/tan cap	Hook & loop	PR	\$21.56



### C. ProFlex® 335 Slip-Resistant Cap

Slip-resistant design grips work surface for a firmer, more stable hold. Tough-as-nails 840 denier nylon fabric stands up to any job. 1/2" neoprene padding provides firm, consistent support without bottoming out. Biomechanically-designed with contoured side cuts for greater knee motion and comfortable fit. Longer design offers maximum surface coverage. Woven elastic straps adjust to an exact fit and improve wearability and comfort. Adjustable buckle easily fastens for a comfortable, exact fit keeps free of dust and grime. Wipes clean with damp cloth. One size adjusts to exact fit.

SKU	Description	Color	Closure	UOM	Price
ERG335	Slip-resistant cap knee pad	Black w/black cap	Buckle	PR	\$22.37
ERG335HL	Slip-resistant cap knee pad	Black w/black cap	Hook & loop	PR	\$21.56

### D. ProFlex® Kneeling Pads

Comfort for static kneeling situations. Closed-cell foam is non-conductive, resistant to petroleum, and silicone-free. Convenient handle.

SKU	Description	UOM	Price
ERG380	Kneeling Pad standard size 14" x 21" x 1"	EA	\$32.46
ERG385	Kneeling Pad large size 16" x 25" x 1"	EA	\$48.74
ERG390	Kneeling Pad x-large size 18" x 36" x 1"	EA	\$63.22







### A. ProFlex® 342 Extra Long Cap Injected Gel Knee Pad

Extra Long Cap All Terrain - Injected Gel: Biggest, baddest knee pad you can get. Monster to the world, teddy bear to your knees and tendons. Features include unique fastening system uses calf muscle to eliminate straps behind knee, patented suspension design redirects pressure away from the patella, cover design delivers stability on all terrain and surfaces, breathable, wide lycra strap with hook & loop closure, adjusts to any calf size, extended shin protection optimizes stability and comfort, silicone-free and fulfils requirements of EN 14404.

SKU	Description	UOM	Price
ERG342	Extra long cap injected gel knee pad	PR	\$84.54

A



B

### B. ProFlex® 347 Long Cap Honeycomb Gel Knee Pad

Long Cap All Terrain - Honeycomb Gel: Lightweight Gel protection and stability. Comfortable elastic straps. Features include patented suspension design redirects pressure away from the patella, patented cover design delivers stability on all terrain and surfaces, 10 mm Honeycomb Gel and EVA foam for lightweight comfort, long cap design optimizes stability, upper and lower elastic straps with hook & loop closure, silicone-free and fulfils requirements of EN 14404.

SKU	Description	UOM	Price
ERG347	Long cap honeycomb gel knee pad	PR	\$55.22

### C. ProFlex® 355 Short Cap Injected Gel Knee Pad

Short Cap All Terrain - Injected Gel: Optimal Gel comfort with two cap options. Great for multiple surfaces. Features include patented suspension design redirects pressure away from the patella, patented cover design delivers stability on all terrain and surfaces, 10 mm Injected Gel and PU foam for long lasting comfort, short cap design for lightweight, mobile protection, snap on cap is easily removed for 2-in-1 kneepad, upper and lower elastic straps with hook & loop closure and silicone-free.

SKU	Description	UOM	Price
ERG355	Short cap injected gel knee pad	PR	\$42.39

C



D

### D. ProFlex® 357 Short Cap Honeycomb Gel Knee Pad

Short Cap All Terrain - Honeycomb Gel: Lightweight Gel protection and stability. Comfortable elastic straps. Features include patented suspension design redirects pressure away from the patella, patented cover design delivers stability on all terrain and surfaces, 10 mm Honeycomb Gel and EVA foam for lightweight comfort, short cap design for lightweight, mobile protection, upper and lower elastic straps with hook & loop closure, silicone-free and fulfils requirements of EN 14404.

SKU	Description	UOM	Price
ERG357	Short cap honeycomb gel knee pad	PR	\$30.67

### E. ProFlex® 367 Low-Profile Cap Honeycomb Gel Knee Pad

Low-Profile Cap - Honeycomb Gel: Gel comfort and roll-over prevention. If the job is more about leaning, here's your kneepad. Features include low profile cap prevents roll-over, 10 mm Honeycomb Gel and EVA foam for lightweight comfort, short cap design for lightweight, mobile protection, grooved cap design for added grip, upper and lower elastic straps with hook & loop closure, silicone-free and fulfils requirements of EN 14404.

SKU	Description	UOM	Price
ERG367	Low-Profile cap honeycomb gel knee pad	PR	\$36.53

E



# Hazmat

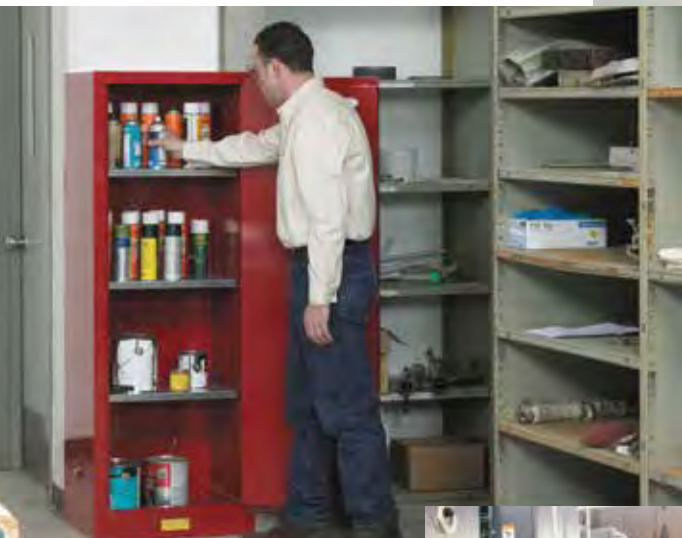



A



### A. Sure-Grip® EX Drum Safety Cabinets

These Vertical Drum Storage Cabinets safely house one 55-gallon drum. All cabinets are supplied with a removable, adjustable half-depth shelf to store Class III materials or spare accessories such as drum funnels, vents and antistatic wires. Cabinets are also designed to accommodate a drum equipped with a pump or funnel so the cabinet may be used as a pumping station or for waste accumulation. Cabinets are offered with and without roller assemblies which facilitate the movement of heavy drums.

SKU	Description	Capacity Gallons	Dimensions H x W x D	Approv./List Regulations	UOM	Price
JUS896220	Vertical drum cabinet self closing	1-55	65 x 34 x 34	FM,N,O,U	EA	\$1287.25

B



### B. Sure-Grip® EX Yellow Safety Cabinet for Flammables

With Justrite's Sure-Grip® EX cabinets, you are assured of getting the best possible protection. Distinguishable differences like a versatile U-Loc™ padlockable handle and Haz-Alert™ reflective labeling system offer added convenience and safety. Welded construction and a 3-point, stainless steel bullet latching system help reduce fire risks. High performance, long-life design is backed by an industry first, Ten-Year Warranty.

Sure Grip® EX design offers exclusive features to make a workplace EXtra safe, EXtra secure:

- Exclusive U-loc™ padlockable handle comes with a double key set and/or accepts an optional padlock
- Exclusive Haz-Alert™ reflective labeling provides high-visibility under fire conditions and power outages
- Unique SpillSlope™ galvanized steel shelves safely direct incidental spills to back and bottom of leaktight, 2" bottom sump

Protect workers, reduce fire risks, and improve productivity by storing hazardous liquids in code compliant safety cabinets. Designed to meet OSHA and NFPA standards, Justrite's cabinets are sturdily constructed of all-welded, 18-gauge, double-walled steel with 1-1/2" of insulating air space for resistance. Finished inside and out with a powder coat paint for durability and chemical resistance. Complies with OSHA and NFPA regulations and all cabinets are FM Approved.

SKU	Description	Doors	Style	Capacity	External H	External W	External D	Adj. Shelves	List/Approval	UOM	Price
JUS893000	Yellow safety cabinet for flammables	2	Manual close	30 gal	44"	43"	18"	1	FM	EA	\$724.98
JUS893020	Yellow safety cabinet for flammables	2	Self-close	30 gal	44"	43"	18"	1	FM	EA	\$811.21
JUS894520	Yellow safety cabinet for flammables	2	Self-close	45 gal	65"	43"	18"	2	FM	EA	\$986.57
JUS896000	Yellow safety cabinet for flammables	2	Manual close	60 gal	65"	34"	34"	2	FM	EA	\$1081.39
JUS896020	Yellow safety cabinet for flammables	2	Self-close	60 gal	65"	34"	34"	2	FM	EA	\$1175.49
JUS899000	Yellow safety cabinet for flammables	2	Manual close	90 gal	65"	43"	34"	2	FM	EA	\$1359.67
JUS899020	Yellow safety cabinet for flammables	2	Self-close	90 gal	65"	43"	34"	2	FM	EA	\$1548.45





### A. Type I Red Safety Cans



Compliant and economical Justrite Type I safety cans reduce fire risks and make everyday use of flammables easier and safer. Protection features include a 3.5" (88mm) long chemical resistant stainless steel flame arrester that stops flashback ignition, provides faster liquid flow, and offers exceptional durability. The self-venting, self-closing leakproof lid prevents ruptures from pressure build-up and controls vapors and spills. Warning label includes an extra large ID zone for user labeling of contents to avoid misuse, reduce the potential for incompatible mixtures, or may be used to designate department or individual owner. Made of galvanized steel with a tough powder paint finish, can capacities 1 gallon (4L) and above have ample headspace to accommodate oil additives.

SKU	Description	Capacity	Dia.	Height	Approval/List	UOM	Price
JUS10801	Type I red safety can w/o funnel	5 gal	11 1/2"	16 3/8"	FM, UL,ULC	EA	\$40.02
JUS11202Y	1'm Easy Funnel		1/2"	11 1/4"	FM	EA	\$6.46

### Optional Colors for Type I Safety Cans

Type I safety cans are available in a variety of colors that are suitable for the storage of flammable liquids. Now it's easy to differentiate between various types of liquids and avoid costly errors when more than one type of liquid is needed at a particular worksite.

SKU	Description	Capacity	Dia.	Height	Approval/List	UOM	Price
JUS10811	Safety can yellow	5 gal	11 1/2"	16 3/8"	FM,UL,ULC	EA	\$45.35
JUS10810	Safety can blue	5 gal	11 1/2"	16 3/8"	FM,UL,ULC	EA	\$45.35

### B. Red Oily Waste Can with Foot Operated Cover

Dispose of oil soaked rags and protect your facility from fires that can start due to spontaneous combustion, sparks or careless use of smoking material. OSHA compliant oily waste cans are essential whenever solvent cloths and wiping rags are used. Rags and cloths soaked with solvents, thinners, linseed oil, combustible adhesives and other flammable liquids present a serious fire risk when improperly discarded. The specially designed lid opens no more than 60 degrees and stays closed when not in use, isolating contents from fire sources. Round construction and elevated bottom encourage circulation of air around the can to disperse heat and reduce moisture build-up and rusting. Container has a high-grade coated steel body construction with a durable powder-paint finish. FM tested and approved; UL listed.

SKU	Description	Cap.	OD	Height	UOM	Price
JUS09100	Oily waste can w/foot operated cover	6 gal	11 7/8"	15 7/8"	EA	\$61.84
JUS09300	Oily waste can w/foot operated cover	10 gal	13 15/16"	18 1/4"	EA	\$70.73
JUS09700	Oily waste can w/foot operated cover	21 gal	18 3/8"	23 7/16"	EA	\$118.33



### C. Aerosolv® Aerosol Can Disposal System

Safe, convenient, easy-to-use, economical and compliant way to dispose of aerosol cans. Changes cans from solid hazardous waste to a non-hazardous, fully recyclable state. Every 100 cans punctured and emptied increases recyclable scrap metal by 25 lb. and reduces solid waste by 10 cubic feet. The contents of over 4,000 spent aerosols may be collected in just one 55 gallon drum. The puncturing unit threads into the 2" bung of a standard 55-gallon drum. All moving parts are 308 stainless-steel. Accepts series 200, 300 and 6 oz. cans. No power source is needed. Carbide-tipped piercing pin displays no visible signs of wear after puncturing 10,000 aerosol cans. Super system includes a lockout and shutoff mechanism that positively seals the unit and the drum when not in use. A padlock with key is included to insure against use by unauthorized personnel. Super system is also easier to keep clean as dirt and grime slide off its Teflon® coated body. A 32 oz. bottle of degreaser is included. Color changing combination coalescing/carbon filter signals saturation and eliminates premature changing of upper activated carbon cartridge. Complies with EPA 40 CFR 261.23(a)6.

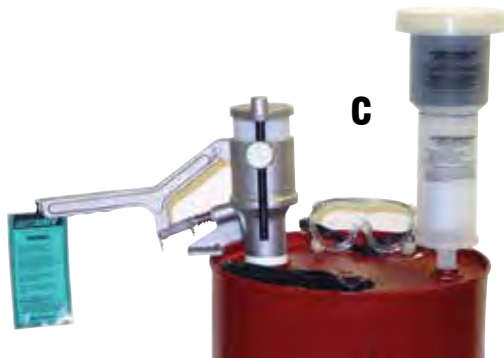

SKU	Description	UOM	Price
JUS28202	Aerosolv® standard aerosol can disposal system	EA	\$909.00
JUS28197	Coalescing/carbon filter	EA	\$166.37



### A. Ultra-Drum Truck®

Drum handling, dispensing and containment in one unit. This drum dolly features a rugged polyethylene construction that offers excellent chemical resistance, a large containment sump (66 gallons) that meets SPCC and EPA Containment Regulations. Unlike alternative products, the open containment sump does not require spills to flow inside the double walls to meet EPA regulations — easy to clean; eliminating residue concerns as related to compatibility. Can be used with 55- or 30-gallon drums — nylon strap keeps drums secure. Ergonomically designed for safe and easy handling and large 10" wheels roll easily over shop and factory floors.

SKU	Description	UOM	Price
ULT1310	Drum dolly, yellow	EA	\$805.26



A



B

ULT0484

ULT0482

### B. Bung Access Ultra-Funnel®

The only full, drum-top funnel which allows access to the 3/4" drum bung. It eliminates the mess caused by overfilling! Unique zig-zag channeled surface diffuses splashing. Level surfaces allow filters, paint cans, buckets and bottles to remain upright while draining passively. It's also lockable for secure drum management.

SKU	Description	UOM	Price
ULT0482	Drum funnel, bung access with spout, yellow	EA	\$50.88
ULT0484	Drum funnel, bung access with hinged lid and spout, yellow	EA	\$101.75

### C. Ultra-Overpacks®

Versatile Ultra-OverPacks offer the highest UN and DOT certifications available. The 30-, 55-, 65- and 95-gallon models comply with UN Packaging Group 1 (X-Rating) and are certified for use as DOT Salvage Drums, 49 CFR 173.3 (c). New Overpack Plus 95 and 65 with screw top lids are the highest performing poly overpacks on the market! High density polyethylene construction offers excellent chemical resistance, including acids, caustics and corrosives. Convenient, "no tools required" closures are perfect for clean-up and spill response activities. Nestable design and low tare weight allow convenient storage and reduced transportation costs. Applications Include: overpacking of damaged or leaking packages, collection and transport of soiled sorbents, clean-up of contaminated sites, emergency response, direct containment and transport of hazardous solids and use as spill kits.

SKU	Description	UOM	Price
ULT0582	Ultra-Overpack Plus 65, yellow	EA	\$175.44
ULT0580	Ultra-Overpack Plus 95, yellow	EA	\$194.74



C



D

### D. Ultra-Spill Pallets®

High load capacity: 6,000 lbs. for 4-drum model, 3000 lbs. for 2-drum model. Bright, safety yellow sidewalls are translucent, offering convenient visual leak detection. 100% polyethylene Construction compatible with a broad range of chemicals, including acids and corrosives. Meets SPCC, EPA Container Storage Regulation 40 CFR 264.175 and UFC Spill Containment Regulations.

SKU	Description	UOM	Price
ULT1000	P4 Plus spill pallet, standard, 4-drum, yellow, no drain	EA	\$436.84
ULT1001	P4 Plus spill pallet, standard, 4-drum, yellow, with drain	EA	\$459.65
ULT1010	P2 Plus spill pallet, standard, 2-drum, yellow, no drain	EA	\$326.32
ULT1011	P2 Plus spill pallet, standard, 2-drum, yellow, with drain	EA	\$350.88



### A. Ultra-Spill Pallets Economy Models®

With the advent of global markets, the business world has never been more competitive. Ultra-Spill Pallet Economy Models have been developed specifically to meet tight budgets for spill containment products. Available in 2-drum and 4-drum configurations. Applications for the all-polyethylene units include satellite waste collection and storage of virgin chemicals. Black color helps hide dirt and grime. Removable grating - makes clean-up quick and easy. Meets SPCC, EPA Container Storage Regulation 40 CFR 264.175 and UFC Spill Containment Regulations.

SKU	Description	UOM	Price
ULT1112	P4 Plus spill pallet, economy, 4-drum, black, no drain	EA	\$361.40
ULT1113	P4 Plus spill pallet, economy, 4-drum, black, with drain	EA	\$385.96
ULT2504	P2 Plus spill pallet, economy, 2-drum, black, no drain	EA	\$243.86
ULT2505	P2 Plus spill pallet, economy, 2-drum, black, with drain	EA	\$268.42

### B. Ultra-Utility Trays®

Keep messy drips and spills off warehouse and factory floors. Heavy-duty polyethylene construction - will not rust or corrode. Ribbed bottom keeps cans, pails and other containers elevated above small spills or leaks. Nestable for easy storage when not in use and available in six sizes for a variety of applications.

SKU	Description	UOM	Price
ULT1031	Utility tray - 12" x 48", black	EA	\$64.91
ULT1032	Utility tray - 24" x 48", black	EA	\$85.96
ULT1033	Utility tray - 30" x 48", black	EA	\$124.56
ULT1034	Utility tray - 24" x 36", black	EA	\$78.95
ULT1035	Utility tray - 36" x 36", black	EA	\$100.00
ULT1036	Utility tray - 40" x 48", black	EA	\$154.39



### C. Ultra-Containment Berms® - Collapsible Wall Model

Economical design sets up quickly - provides secure containment. The Collapsible Wall Model Containment Berm features rugged PVC sidewall assemblies for sidewall support. Simply swivel the "feet" of the PVC supports to lower or raise the sidewalls in just seconds! Meets SPCC and EPA Container Storage Regulation 40 CFR 264.175.

SKU	Description	UOM	Price
ULT8400	Containment Berm, collapsible wall, 10' x 10' x 1'	EA	\$1433.33
ULT8403	Containment Berm, collapsible wall, 6' x 6' x 1'	EA	\$922.81

### D. Ultra-Containment Berms® - Rapid Rise Model

Sidewalls stay lowered and out of the way until they are needed. Sidewalls remain down during normal operations, loading and unloading. Vehicles and equipment can drive in and out with no set-up or take-down required. In the case of a spill, the foam ring around the top perimeter of the Containment Berm rises with the level of spilled liquid. Helps meet EPA Container Storage Regulation 40 CFR 264.175 and SPCC requirements. Standard material of construction is Copolymer 2000™.

SKU	Description	UOM	Price
ULT8432	Containment Berm, rapid rise, 10' x 10' x 1'	EA	\$1638.60
ULT8437	Containment Berm, rapid rise, 12' x 26' x 1'	EA	\$3450.88







### A. Ultra-Containment Berms® - Ultimate Model

Unique, "Living Hinge" design allows hands-free drive in/drive out - no need to manually raise or lower the endwalls. Entry and exit walls are supported every 12" with a patented "living hinge". Once a vehicle has entered or exited, the walls automatically spring back to their vertical position. Both long sidewalls are held upright by PVC sidewall assemblies. Simply swivel the feet to lower the sidewalls for storage or transport to another location. Standard material of construction is Copolymer-2000™. XR5, polyurethane and other materials also available.

SKU	Description	UOM	Price
ULT8505	Containment Berm, Ultimate Model, 12' x 60' x 1'	EA	\$6178.95
ULT8506	Containment Berm, Ultimate Model, 15' x 50' x 1'	EA	\$6149.12
ULT8507	Containment Berm, Ultimate Model, 15' x 66' x 1'	EA	\$7640.35



### B. Ultra-Concrete Washout Berm®

Economical and portable containment for concrete washout. Portable solution for harmful industrial concrete sediment, paint, drywall mud, stucco and mortar. UV resistant, 10 mil polyethylene and unfolds for simple and quick set up in seconds. Compatible with mixer, pump trucks and wheel barrows. Built-in tie-downs allow berm to be secured to standard wooden pallets for easier handling and transport. Dispose of after evaporation and job completion.

SKU	Description	UOM	Price
ULT3512	Concrete Washout Berm, Ultimate Model, yellow, 48" x 48" x 14"	EA	\$87.72

### C. Ultra-Dewatering Bag®

Contain sediment and oil pumped out during dewatering operations. Detains both oil and sediment, offering a combination of benefits not available in alternative dewatering bags. Accommodates up to 4" discharge hose. Helps comply with NPDES, 40 CFR 122.26 (1999) when used as Best Management Practice in Storm Water Pollution Prevention Plans.

SKU	Description	UOM	Price
ULT9724-O/S	Dewatering Bag, oil and Sediment 6' x 6'	EA	\$47.37
ULT9725-O/S	Dewatering Bag, oil and Sediment 10' x 15'	EA	\$152.63
ULT9727-O/S	Dewatering Bag, oil and Sediment 15' x 15'	EA	\$226.32
ULT9729-O/S	Dewatering Bag, oil and Sediment 3' x 4'	EA	\$33.33



### D. Ultra-Drain Seals®

Stop spills from going down the drain. Reinforced mesh is "sandwiched" between layers of polyurethane - increases durability and resistance to tearing. Unique, urethane construction allows the pad to deform and seal off most drains — temporarily "seals" to any smooth surface. A valuable addition to any emergency response plan, spill kit or stormwater management program. Unlike some alternative products, BOTH sides will quickly seal drains - there is no specified "top" or "bottom". Flexible, non-absorbing material with reinforced, tear-resistant mesh. Resists oil, water and most aggressive chemicals, cleans with soap and water.

**NOTE:** Not intended for long-term outdoor use (more than two (2) hours), as UV exposure and/or heat for extended periods can degrade the product. For applications where extended use may be required, the Ultra-Drain Seal Plus should be considered.

*Due to the nature of softer urethane, the physical properties of these products may change with exposure to certain environmental conditions like temperature, humidity and UV radiation. Regular inspection of the stored product should be done to ensure it is in a usable state.*

SKU	Description	UOM	Price
ULT2130	Drain Seal 36" x 36", orange	EA	\$305.26



### A. HazMat Spill Kits

Be prepared with these emergency spill kits. Great for industrial and marine applications. Contains goggles, gloves, sorbent materials and disposal bag.

SKU	Description	Contents	Absorbs	UOM	Price
CEPHAZSK5	HazMat aggressive spill kit	10 pads, 2 socks	5 gal	EA	\$63.64
CEPHAZSK55	HazMat aggressive spill kit	100 pads, 2 booms, 5 pillows	55 gal	EA	\$336.54
CEPSK30	HazMat spill kit, oil only	50 pads, 12 socks, 4 pillows	30 gal	EA	\$333.93
CEPSK55	HazMat spill kit, oil only	100 pads, 2 booms, 5 pillows	55 gal	EA	\$498.67
CEPCSKU2	HazMat truck kit, universal	20 pads, 2 socks	20 gal	EA	\$106.86

### B. Universal Aggressive Sorbent Pads

Universal sorbent pads will absorb all liquids from water based fluids to aggressive acids. An absolute necessity for any hazmat spill or spill contingency planning. Bonded for tensile strength and absorb up to 25 times their weight in liquids.

SKU	Description	Size	UOM	Price
CEPUP100	Sorbent pads, universal	17" X 19"	100/CS	\$65.09



### C. Oil Only Sorbents

Oil only sorbent products are made of pure melt blown polypropylene fibers that quickly pick up to 25 times their weight in hydrocarbon. Choose from a variety of sorbents available.

SKU	Description	Absorb	Size	UOM	Price
CEPB510	Sorbent booms, oil only	32 gal	5' x 10'	4/CS	\$70.25
CEPP100	Sorbent pads, oil only	34 gal	17" x 19"	100/CS	\$63.65
CEPP200	Sorbent pads, oil only	35 gal	17" x 19"	200/CS	\$55.79



### D. Econo Sorbent Pads

CEP pure meltblown polypropylene fibers are the most cost-effective adsorption technology today. Fibers absorb up to 25 times their weight in hydrocarbon. Oil only sorbent.

SKU	Description	Thickness	Absorb	Size	UOM	Price
CEPEP100	Econo sorbent pads, oil only	1/4"	28 gal	17" x 19"	100/CS	\$41.60



### E. 3M™ Petroleum Sorbent Pad HP-156, High Capacity

This high capacity sorbent pad features a low-profile design, so that it can be easily placed in tight areas. Ideal for cleaning up small spills and wiping down contaminated areas. Designed with scrim on one side to increase strength and help eliminate linting. Conveniently sized pad allows the user to quickly spread sorbent over a spill. Pad may also be used on a work surface in anticipation of a spill or as a wipe.

SKU	Description	Absorb	Approx. Size	UOM	Price
3MHP156	Petroleum sorbent pad	37.5 gal/bale	17" x 19"	100 PD/bale	\$67.67

#### WARNING!

Failure to properly handle and dispose of sorbents contaminated by hazardous materials can result in serious physical injury or death and/or environmental harm. For proper handling, consult the Material Safety Data Sheet for the material absorbed, applicable safety and health standards, contact your supervisor, or call 3M OH&ESD Technical Service in the USA at 1-800-243-4630. In Canada, call 1-800-267-4414.

# Poly-America

A



## A. Drum Liner

3-mil polyethylene drum liner fits inside of 55-gallon drums. 38" x 65".

SKU	Description	UOM	Price
POLHWY4-55	Drum liner	55/RL	\$58.93

B



## B. Husky® Sheeting

Poly-America's construction sheeting is made from polyethylene which provides for optimum in economy and performance. Because of its good weatherability, chemical inertness and toughness, Poly-America's polyethylene sheeting has successfully been used for over 20 years in a wide variety of applications.

SKU	Description	Water Vapor(ASTM) Transmission Rate	Dart Impact	UOM	Price
POL420C	Husky® sheeting, 20' x 100', 4 mil	.19 perm	165 g	EA	\$60.00
POL620C	Husky® sheeting, 20' x 100', 6 mil	.13 perm	260 g	EA	\$90.00



## C. AC & DC Duct Canister Fans

This combination ventilation fan and duct storage unit is constructed of rugged polyethylene. Ideal for use as a one-piece ventilation package. Duct canister is securely attached to a light-weight Air System® fan. Axial canister fans are available in AC or DC, with 6', 15' or 25' of duct installed. The DC fan can be ordered with the new Jump-n-Carry battery pack to provide approximately 2 hours of run time. CE registered and CSA approved. Sold individually.

SKU	Description	Weight	UOM	Price
ASISVF25ACAN	AC Axial Canister Fan with 25' Duct Installed	39lbs	EA	\$692.90
ASISVF25DCAN	DC Axial Canister Fan with 25' Duct Installed	39lbs	EA	\$692.90

C



D



## D. Standard Industrial Saddle Vent®

The standard Industrial Saddle Vent, 2AM94, is made of orange polyethylene and is used for all non-hazardous ventilation applications

SKU	Description	UOM	Price
ASISV189	Saddle Vent	EA	\$148.10
ASISVUM	Universal Mount for Saddle Vent	EA	\$48.66



# Facility

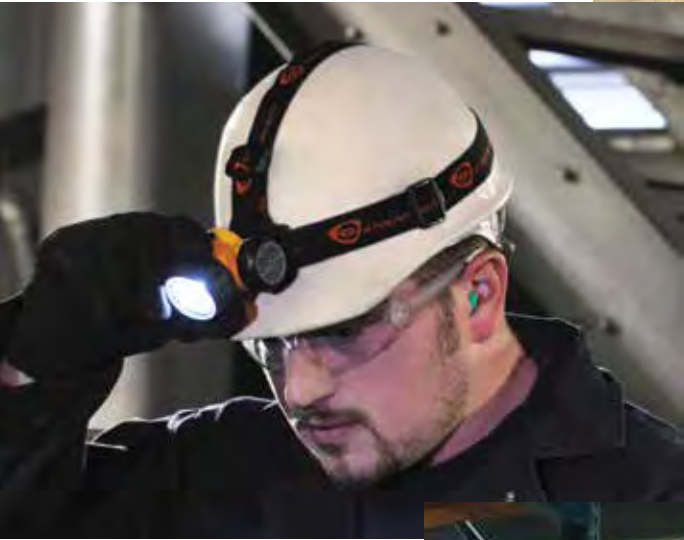

### A. Safety Station Eye Wash and Shower

Features a 10" safety orange ABS plastic showerhead with 1" IPS chrome plated brass stay-open ball valve and stainless-steel actuating arm and stainless-steel pull rod. Two GS-Plus spray heads mounted on chrome plated brass supply arms complete the outlet head assembly. Each GS-plus spray head has "flip-top" dust cover, internal flow control and filter to remove suspended solids from water flow. 11-1/2" stainless-steel or safety orange ABS plastic bowl. Eye wash valve is a 1/2" IPS chrome plated brass stay-open ball valve with epoxy-coated cast aluminum flag handle and 1-1/4" IPS Schedule 40 hot-dipped galvanized steel; 9" cast aluminum floor flange. Has 1-1/4" IPS female top or side inlet supply and 1-1/4" IPS female outlet waste. This unit meets ANSI Z 358.1 standard as primary eye wash and safety shower. Comes with ANSI-compliant identification sign.

SKU	Description	UOM	Price
GREG1902	Safety station eyewash and shower w/ stainless steel bowl	EA	\$791.92
GREG1902P	Safety station eyewash and shower w/ orange ABS plastic bowl	EA	\$703.34
GREG1902BC	Safety station eyewash and shower w/ stainless steel bowl cover	EA	\$983.51



### B. 15 Gallon Portable Eyewash/Drench Hose Unit

Self-contained eyewash and/or drench hose units are ideal where a continuous supply of potable water is not available. These units may be used in low traffic areas, low hazard areas or where installation of plumbed equipment is not cost effective. Fifteen gallon units provide approximately 10 usable gallons (37.9 liters) of water for effective rinsing of the eyes, face or body. 15 gallon stainless steel pressurized tank. Tank has built-in carrying handles, air intake fitting, pressure gauge and pressure relief valve. Tank has approximately 10 gallons (37.9 liters) usable capacity. Two GS-Plus spray heads, each with a "flip-top" dust cover, internal flow control and filter. 1/2" IPS chrome plated brass stay-open ball valve with flag handle. Pressure regulator controls eyewash flow to 0.65 GPM for 15 minutes. Single GS-Plus spray head with "flip-top" dust cover, internal flow control and filter. Chrome plated brass squeeze valve with stainless steel lever handle and 6 ft. reinforced PVC hose.

SKU	Description	UOM	Price
GREG1562	15 gallon portable eyewash with drench hose unit	EA	\$1032.64



### C. Sellstrom® Gravit-Eye™ Portable Eye Wash Unit

The Sellstrom® Gravit-Eye™ self-contained gravity flow eye wash unit uses gravity to deliver water through dual spray heads. The unit delivers over fourteen gallons (53 liters) of water for fifteen minutes, thus complying with the provisions of ANSI Z358.1-2004 for eye washes. Units have a rugged plastic tank that can be installed in a wide variety of locations. These units are ideal for use where a continuous supply of potable water is not available, especially in remote plant areas, low traffic and/or low hazard areas. Tank has built-in carrying handle, heavy wall construction and reinforced ribs to support weight of unit. Furnished with epoxy coated steel bracket for mounting unit on wall. Unit can also be placed on counter top or other flat surface. One bottle of 8 oz. bottle of bacteriostatic additive is included to protect against growth of bacteria and other impurities in portable unit. Unit is completely assembled and water tested prior to shipment.

Sellstrom's water collection tanks provide a quick, clean option for water disposal and testing. The tank is equipped with a roller base that locks into place so it is easy to move and store around facility. A drain plug is also provided for easy disposal.

SKU	Description	UOM	Price
SEL90320	Eye wash station gravity flow 16 gal	EA	\$190.42
SEL90322	Redi-Sep Bacteriostatic 8 oz additive	EA	\$5.78
SEL90335	Dust cover for gravity flow eyewash station	EA	\$35.78



SEL90320

SEL90322



### A. SENTRY® Dry Chemical Extinguishers

Dry chemical extinguishers are designed for protection of light, ordinary and extra high hazards. These compact and portable extinguishers are suited for both industrial and commercial fire protection needs. All extinguishers are designed to fit most wall mounted storage cabinets. Typical applications include light manufacturing, warehousing, restaurants, office buildings, shop areas, auto repair shops, paint process areas, welding areas, machinery, apartment buildings, parking garages, aircraft servicing areas, material handling vehicles and many others. DOT and USCG approved with proper bracket. Meets or exceeds requirements of ANSI/UL 299 and 711.

SKU	Description	Agent Capacity	UL Rating	UOM	Price
ANSU429101	SENTRY 2 1/2 w/vehicle bracket	2 1/2 lb. FORAY	1-A: 10-B: C	EA	\$39.60
ANSU429102	SENTRY 5	5 lb. FORAY	3-A: 10-B: C	EA	\$50.42
ANSU429003	SENTRY 10	10 lb FORAY	10-A: 60-B: C10	EA	\$80.25
ANSU429006	SENTRY 20	20 lb. FORAY	20-A: 120-B: C	EA	\$143.93
ANSU24610	SENTRY 2 1/2 bracket			EA	\$6.87
ANSU429146	SENTRY 5 bracket			EA	\$10.20
ANSU30937	SENTRY 20 bracket			EA	\$79.80

### B. Fire Extinguisher Covers

Protects fire extinguishers from the weather. Features clear fluorescent orange reinforced vinyl with hook and loop closures.

SKU	Description	UOM	Price
PEKFIREFCOV	Cover, fits 5-13 lb. extinguishers	EA	\$10.88
PEKFIREFCOVLG	Cover w/ window, fits 15-30lb. extinguishers	EA	\$13.95



p.e.k., Inc.

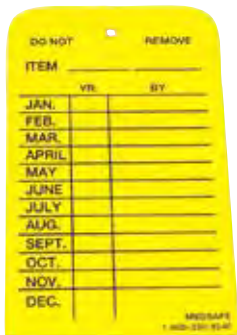

### C. Fire Inspection Tag

Notify workers that the monthly fire inspection has been completed with these inspection tags.

SKU	Description	UOM	Price
FIREINSPTAG	Fire inspection tag	EA	\$ .34

### D. Fire Extinguisher Pull Pin Seals

9" long polypropylene seals indicate tampering at a glance; yet readily break away upon activation. Pull pin seals can also be used to seal any important merchandise, emergency supply cabinets, etc. Meets UL Specs. 12 - 14 lb. test.

SKU	Description	UOM	Price
DOOLBTS-Y	Pull pin seals	500/PK	\$66.99

### E. Fire Extinguisher Pull Pins

Steel single point pull pin. 2.75" total length with thin shaft.

SKU	Description	UOM	Price
DOOLNPP	Pull pins	EA	\$.40

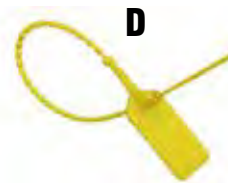



### A. Smokers Cease-Fire® Cigarette Butt Receptacle

Utilizing Justrite's proven Cease-Fire® technology, the Smokers Cease-Fire® innovative self-extinguishing design safely collects unsightly cigarette butts and reduces the risk of fire. Made of flame-retardant, sturdy polyethylene, this low-maintenance smoker's friend won't rust, dent or crack. Unique rain bonnet opening keeps rain out and discourages other trash. Simply lift off lid to empty big galvanized steel pail inside. Tie-down notches offer security and greater stability under severe weather conditions. In high humidity environments, unique "drip-lip" internal construction prevents tar condensation from escaping. FM Approved. Other colors available but not commonly stocked. ADA compliant.

SKU	Description	Size	Color	UOM	Price
JUS26800	Cigarette butt receptacle	16 1/2" x 38 1/2"	Pewter Gray	EA	\$57.54
JUS26800D	Cigarette butt receptacle	16 1/2" x 38 1/2"	Deco Black	EA	\$57.54



**A**



**B**

### B. Heavy Duty Butt Cans

Only 11.5" (292mm) in diameter, these slim styled receptacles take up minimal space while offering a safe, convenient way to keep unsightly butt litter out of view. Base and neck tube are made of durable, fire-safe galvanized steel and are finished in a tough powder coat paint for rust resistance. Polyethylene topper keeps rain out and identifies unit for cigarettes only.

To empty contents, simply untwist compression nut where neck tube meets the base... no separate screw to lose! ADA compliant height.

SKU	Description	UOM	Price
JUS26811	Heavy duty butt cans red	EA	\$75.59



### C. SBS™ 46 Solvent Resistant Protective Cream

Unequaled protection against oil and solvents. Protects against and aids in the removal of: greases, oils, lacquers, mastics, caulks, hydraulic fluid, tar, inks, dyes, rubbers, carbon, graphite, and many other solvent-based materials and dry powders.

SKU	Description	Size	UOM	Price
DEBS46135	SBS 46 protective cream	5 oz	EA	\$4.50



**C**



**D**

### D. SBS™ 44 Water Resistant Protective Cream

Formulated for health care personnel, kitchen staff, food plant employees, or anyone exposed to water-based irritants, detergent solutions, juices, vinegar, acids, alkalies, alcohol, cutting fluids, plating solutions, cleaning agents and more.

SKU	Description	Size	UOM	Price
DEBS44135	SBS 44 protective cream	5 oz	EA	\$4.56



### A. SBS™ 40 Medicated Skin Cream

Superior medicated skin cream to help condition, soothe and heal skin. SBS-40's lightly scented formula absorbs completely.

SKU	Description	Size	UOM	Price
DEBS40135	SBS 40 medicated skin cream	5 oz	EA	\$3.99
DEBS40127	SBS 40 medicated skin cream	1 liter	EA	\$12.60



### B. AeroGreen™ Antibacterial Foam Hand Wash

An antibacterial foam hand wash with Tricolsan for frequent hand washing in general areas. Used in office/commercial/leisure, medical rooms & laboratories, food service & catering.

SKU	Description	Size	UOM	Price
DEBS57952	AeroGreen™ antibacterial foam hand wash	1 liter	EA	\$11.12



### C. GrittyFOAM™

Heavy-duty foam hand cleanser with grit. Non-abrasive environmentally sustainable bio-scrubbers suspended in thick, creamy and deep cleaning foam. Slight citrus aroma produced by citrus based ingredient, no added fragrance or dye. Cartridges contain 3250 milliliters and are ultrasonically sealed, non-vented, and fully recyclable (HDPE Type 2). EcoLogo™ certified, USDA BioPreferred accreditation, and VOC compliant. Formulated for one dose application. Dispensed from proprietary, Biocote® protected dispenser at the rate of 3 milliliters per push.

SKU	Description	Size	UOM	Price
DEBSGPF3LNA	GrittyFOAM citrus cartridge 2/case	3.25 Liter	CS	\$74.64
DEBSGPF3LDQ	GrittyFOAM 3250 black dispenser		EA	\$47.85



### D. SCRUBS in-a-Bucket®

SCRUBS in-a-Bucket® are the original premoistened, heavy duty hand cleaner towels that go where you go. SCRUBS® towels easily remove soil from your hands and leave them clean anywhere you are working. No rinsing necessary. Powerful, yet safe, patented citrus-based formula works together with an absorbent, non-scratching abrasive hand cleaner towel for proven performance. Towels measure 10 1/2" x 12 1/4".

SKU	Description	Count	UOM	Price
LAG422L	SCRUBS® waterless towels	72/bucket	EA	\$20.41



### E. Rags

Rags are made from medium weight woven cotton and cotton blends in solid white from reclaimed garments. The lint free white sheets are 2-6 oz/sq yard sheets and are produced from white woven flat cotton and cotton blended sheeting and pillowcases.

SKU	Description	UOM	Price
HOUW1101-25	Rags	25lbs/BX	\$29.82
HOUW1201-25	Lint free white sheets	25lbs/BX	\$41.67

### A. 2AA ProPolymer®

Tough, super-convenient, extra bright flashlight. Now with a push-button tail switch. It's co-molded grip ensures it'll stay in your hand.

SKU	Description	UOM	Price
STRE67101	2AA LED yellow with alkaline batteries	EA	\$26.02



### B. 4AA ProPolymer®

The 4AA ProPolymer is a tough, waterproof, super-bright alkaline battery-powered flashlight with one high-intensity xenon bulb that provides 11,000 peak beam candlepower. The 4AA ProPolymer LED is an impact and shock resistant LED flashlight that provides 155 hours of run time. Features 7 ultra-bright 100,000-hour life LEDs. The 4AA ProPolymer LUX are now C4® LED with 100 lumens, 6 hour runtime. All are ergonomically shaped for maximum hand comfort.

SKU	Description	UOM	Price
STRE68602	4AA LUX DIV 1 yellow with alkaline batteries	EA	\$51.32
STRE68244	4AA LUX DIV 2 yellow with alkaline batteries	EA	\$47.37



### C. 3C ProPolymer®

The 3C ProPolymer is a powerful and incredibly handy flashlight that features a momentary blink or constant on tail cap switch. The 3C ProPolymer LED is an impact and shock resistant LED flashlight that provides 336 hours of run time.

SKU	Description	UOM	Price
STRE33202	3C LED yellow batteries not included	EA	\$48.32



### D. TRIDENT® Headlamp

When you need a light that will provide you with the broadest range of lighting applications for everyday use, whether distance or "up close" work, the multi-purpose Trident headlamp provides a good mix of both for users. C4 LED for super-bright light with usable range: 4,000 candela peak beam intensity; 80 lumens; 126m beam distance; 5 hour run time. Push-button switch is easy to use when wearing gloves and is recessed to protect it from inadvertent activation. 90° tilting head features a robust ratcheting system; prevents neck fatigue. Includes elastic head strap and rubber hard hat strap.

SKU	Description	UOM	Price
STRE61050	Trident with alkaline batteries	EA	\$30.60

### E. Argo® Headlamp

If you often find yourself needing to illuminate objects at a distance, the long-range capability of the Argo delivers a far-reaching beam. High for maximum output with a long-range beam distance: 150 lumens, 9,250 candela peak beam intensity, 3 hour run time, 190m beam distance. Push-button switch is easy to use when wearing gloves and is recessed to protect it from inadvertent activation. 90° tilting head features a robust ratcheting system; prevents neck fatigue. Durable, co-molded rubber body. Includes elastic head strap and rubber hard hat strap.

SKU	Description	UOM	Price
STRE61301	Argo headlamp w/3-AAA batteries	EA	\$39.47



### F. 3AA HAZ-LO® Headlamp

The first safety approved headlamp for Class 1, Div 1 hazardous locations! The 3AA Haz-LO is an engineered compact, high-performance, C4® LED headlamp to meet the stringent requirements of class 1, division 1 hazardous locations while maintaining exceptional light output and a long run time. LED delivers 120 Lumens for up to 11 hours. Intrinsically safe for use in atmospheres containing hazardous gases, vapors and liquids. Weighs 7.1 oz.

SKU	Description	UOM	Price
STRE61200	HAZ-LO w/3-AAA alkaline batteries	EA	\$52.89





### A. SabreLite™ Flashlight



The SabreLite is made of unbreakable Lexan EXL 9330 material with a hi-impact polycarbonate lens. The SabreLite has an exclusive state-of-the-art laser spot xenon lamp module that produces a tightly focused white light beam. Includes a belt clip, stainless-steel split ring and black lanyard allowing the flashlight to be attached to a pocket, belt or a hand. Accidental turn on and mechanical switch failure is eliminated because of the rotary on/off switch. It also includes a safety battery tray with 3C cell alkaline batteries (not included) in order to avoid accidents if the cells are inverted. Submersible. Made in USA.

SKU	Description	Color	UOM	Price
PEL2000B	SabreLite, boxed	Black	EA	\$33.85
PEL2000Y	SabreLite, boxed	Yellow	EA	\$33.85

### B. PeliLite™

The PeliLite™ is made of unbreakable ABS material with a hi-impact polycarbonate lens. Its laser spot Xenon lamp module can cut through, smoke, fog, and rain, making it a perfect light source for all applications. Accidental turn on and mechanical switch failure is eliminated because of the rotary on/off switch. It requires 2-C cell alkaline batteries (not included) and is submersible. FM, CSA and MSHA approved. Made in the USA.

SKU	Description	UOM	Price
PEL1800C	Super PeliLite flashlight	PK	\$27.53



### C. MityLite™ Laser Flashlight

Unbreakable polycarbonate resin flashlight is 4 3/4" long. Its laser spot Xenon® lamp module can cut through water, smoke, fog and rain making it a perfect light source for all applications. The MityLite is compact, lightweight and equipped with a shirt clip, making it easy to fit into pockets, purses, tool kits, camera bags or glove compartments. Accidental turn on and mechanical switch failure is eliminated because of the rotary on/off switch. CSA and UL approved. Made in the USA.

SKU	Description	Color	UOM	Price
PEL1900M	Laser flashlight	Black	EA	\$13.00

### D. Tracker™ Light

Tracker™ is a handy pocket flashlight of 3-1/2" (9 cm) in length which attaches to almost anything making it an ideal hands free flashlight. The Tracker™ easily fits into tool/fishing boxes, photographer's equipment, travel bags and is perfect for any outdoor activity, scuba diving, home, office or emergency lighting. Submersible to 500 feet, the Tracker™ is ideal for anyone to use as a warning or emergency light. It includes 2-AAA cell Alkaline batteries and is UL approved. You break it, we replace it... forever.

SKU	Description	UOM	Price
PEL2140	Tracker light	EA	\$15.18



### E. VersaBrite®

VersaBrite is made of Xenoy/Polycarbonate material. The VersaBrite features a multiple position swivel head that allows you to point the bright beam where you need it. Due to its compact size and only 3.17 oz of weight, the VersaBrite securely clips on to visors, caps and clothing. A head strap, Velcro and clip are available to keep hands free to work. It includes 2-AA cell alkaline batteries and is water-resistant (not for diving applications).

SKU	Description	UOM	Price
PEL2250	VersaBrite	EA	\$22.65



### A. Bright Star Industrial Flashlight

Specially designed to provide durable reliability for the industrial markets. Sure-gripped ribbed case is molded from a specialty blended industrial polypropylene that resists most chemicals, oils and grease. Switch guard prevents accidental lighting. Features unbreakable Tuflexx® lens, anti-roll design with lens ring standoffs, ABS plastic ring hanger and spare bulb compartment.

SKU	Description	Color	UOM	Price
BRI2618	2 D-cell flashlight	Yellow	EA	\$8.05



### B. Bright Star WorkSAFE® D-Cell Flashlights

WorkSAFE flashlights feature a crush-resistant case, unbreakable lens, switch guard, spare bulb holder, ring hanger and anti-roll design. Molded in international safety orange. UL, CSA and MSHA approved for Division 1 hazardous locations. The waterproof design of these safety-approved lights make them ideal for places where safety is necessary and water is a concern. Each flashlight features a waterproof 3-way switch. When in the middle position, the button on the switch can be pressed to provide intermittent light.

SKU	Description	UOM	Price
BRI2117	2 D-cell flashlight	EA	\$10.15
BRI2217	2 D-cell waterproof flashlight	EA	\$12.84

### C. Industrial 2D Value Bright Light

The Industrial 2D Value Bright Light runs off two D cell batteries. It is made of heavy duty polyethylene with a polystyrene lens. Features 2750 peak beam candlepower, a lanyard for hanging or use as a wrist strap and an easy to slide switch.

SKU	Description	UOM	Price
RAYIV2D	Industrial 2D value bright light	EA	\$2.93



### D. Lighted Aircraft Wand

A versatile, multi-use that sets the industry standard for: marshalling aircraft, directing traffic, directing pedestrians and construction zones. It is the brightest, most durable LED Wand on the market and is water-proof, grease-proof and spark-proof. Three super-bright LEDs provide 100,000 hours of burn time while 2 "C" batteries will last up to 300 hours. Features a heavy-duty switch for smooth, reliable functions. This wand has less breakage; less "walk-offs," and is UL rated for hazardous locations. Patented.

SKU	Description	UOM	Price
NEW3251-00E	Lighted aircraft wand	EA	\$12.05



**A**

### A. Alkaline Batteries

Rayovac alkaline batteries are the smart choice for your battery-powered devices because they last as long as other leading brands, but cost less.

SKU	Description	UOM	Price
RAYOAL-9V	Alkaline batteries 9V	EA	\$1.89
RAYOAL-AA	Alkaline batteries AA	EA	\$ .48
RAYOAL-AAA	Alkaline batteries AAA	EA	\$ .48
RAYOAL-C	Alkaline batteries C	EA	\$ .93
RAYOAL-D	Alkaline batteries D	EA	\$ .98



### B. OLFA Self-Retracting Safety Cutter

The SK-8 is a fully automatic heavy duty automatic self-retracting safety knife. It is an extra protection safety cutter featuring a blade that automatically retracts the instant it loses contact with material being cut, even when the blade slider is engaged. By simply reversing the way the blade fits into the blade slide, this knife can be used right or left handed. The contoured handle cushions your hand as you cut and is non-slip.

SKU	Description	UOM	Price
OLFASK-8	Self-retracting safety cutter	EA	\$15.19
OLFASKB-8	Self-retracting cutter replacement blades 10/PK	PK	\$6.23



**B**



SKB-8

### C. OLFA Compact Safety Cutter

The OLFA SK-7 has a compact handle designed to fit any size hand. It has a spring retractable safety design. It will automatically retract the instant the blade loses contact with the cutting surface. By simply reversing the way the blade fits into the blade slide, this knife can be used right or left handed. The blade slide is recessed so the user can easily slide the cutter into their pocket without fear of the blade being extended.

SKU	Description	UOM	Price
OLFASK-7	Compact safety cutter	EA	\$7.04
OLFASKB-7	Compact safety cutter replacement blades 10/PK	PK	\$5.42



**C**



SKB-7

### D. Duct Tape

Silver economy duct tape comes in rolls of 2" X 60 yd and can be used in bundling and packaging.

SKU	Description	UOM	Price
MUTU17807	Duct tape grey 2" X 60 yd	RL	\$4.40

**D**





### A. 3M™ Scotch® Vinyl Electrical Tape

Primary electrical insulation for all wire and cable splices rated up to 600 volts. Resistant to weather, UV ray, abrasion, corrosion, alkalis and acids. Provides a protective jacketing for high voltage cable splices and repairs. Made in the USA.

SKU	Description	Color	UOM	Price
3M10828	Scotch vinyl electrical tape	White	RL	\$5.64
3M10836	Scotch vinyl electrical tape	Blue	RL	\$5.27
3M10844	Scotch vinyl electrical tape	Yellow	RL	\$5.27
3M10851	Scotch vinyl electrical tape	Green	RL	\$5.27
3M10869	Scotch vinyl electrical tape	Orange	RL	\$5.62
3M10810	Scotch vinyl electrical tape	Red	RL	\$5.64

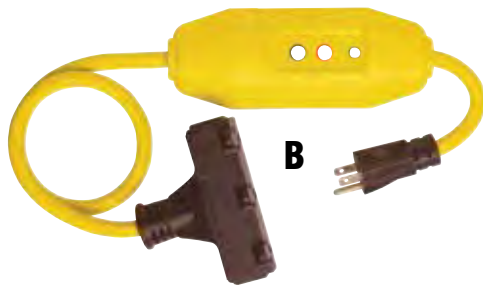
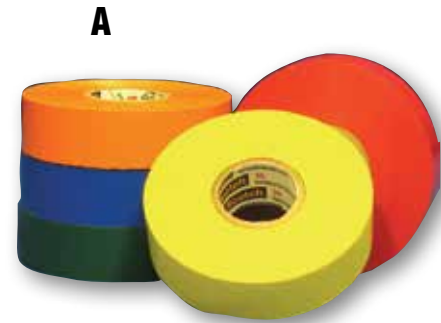

### B. In-Line GFCI

In-line GFCI protection from ground faults and open neutral conditions anywhere electrical equipment is used. Rainproof outdoor rated. UL listed and meets OSHA specifications.

SKU	Description	Card	Length	Amps	UOM	Price
MSSGFCI3OUT	In-line GFCI and triple tap cord set 125V	12/3 AWG SJTW	3'	15A	EA	\$32.50



### C. Cushion Trax®

Cushion Trax® is engineered to meet the toughest requirements of today's industrial applications and is particularly suited for multi-shift operations in dry work areas. The durable vinyl diamond-plate design provides non-directional traction, and is easy to clean. The top surface is combined with a dense closed cell foam base utilizing NoTrax® exclusive UniFusion™ technology virtually eliminating the possibility of de-lamination. Contact customer service for other sizes and colors.

SKU	Description	Size	Color	UOM	Price
SUP479S0023Y	Cushion Trax	2' x 3'	Yellow & Black	EA	\$58.55
SUP479-23BL	Cushion Trax	2' x 3'	Black	EA	\$52.48
SUP479S0035Y	Cushion Trax	3' x 5'	Yellow & Black	EA	\$146.37
SUP479-35BL	Cushion Trax	3' x 5'	Black	EA	\$131.21

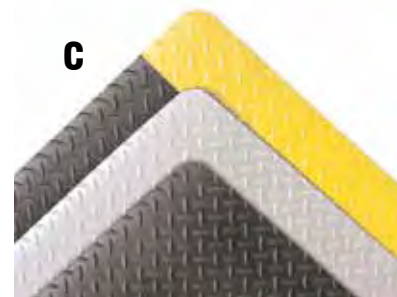

### D. Outdoor Convex Detection Mirrors

Outdoor Convex Detection Mirrors help monitor blind spots and are designed to prevent intersection accidents in an industrial application. Convex mirrors can be positioned to reflect a hidden area to a forklift operator. These mirrors can also be directed to allow equipment operators to view co-workers approaching from behind to reduce accidents.

SKU	Description	Size	UOM	Price
SEKCVO-36	Mirror outdoor convex	36"	EA	\$189.91



### A. The Forklift Spotter

The Forklift Spotter provides visual warning for pedestrians and promotes greater safety with a bright blue spot beam pattern projecting onto the ground. It features a UV-resistant polycarbonate lens, rugged aluminum housing that prevents rust and corrosion. Configured for 12-48 VDC. Long-lasting LEDs (30,000 Hour Service Life) means never having to replace another bulb! Optional universal mounting kit.

SKU	Description	UOM	Price
IDL701095	The Forklift Spotter	EA	\$185.97
IDL7010911	The Forklift Spotter Universal Mounting Bracket	EA	\$26.28
IRN7010951	Warning Safety Sign	EA	

### B. Accu-Tilt Fork Tilt Level Indicator

The Accu-Tilt shows the operator the level of the forks at all times thereby reducing potential damage by piercing product or racking and increasing productivity by eliminating the guess work.

SKU	Description	UOM	Price
IRN701000	Accu-Tilt Fork Tilt Level Indicator	EA	\$174.14

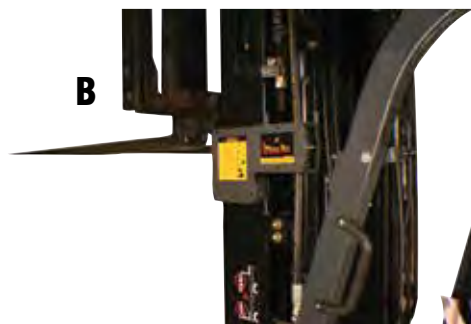

### C. Accu-Height Fork Height Level Indicator

The higher the lift, the harder it is to judge the correct height of the forks. Accu-Height is a simple sticker set that allows the operator to quickly know the right height of the forks at various rack levels. By matching the indicator sticker with the color marker, the correct fork height is obtained to enter the pallet safely. The second marker indicates the safe lift height of the pallet to be either removed from the rack or to be placed in to the rack.

SKU	Description	UOM	Price
IDL701100	Accu-Height Fork Height Level Indicator	EA	\$27.15

### D. Anti-Blind Spot Dome Mirror

Lift truck operators need to know what is going on all around the lift truck. This mirror gives a complete 180° view allowing the operator to give a quick safety check before they travel in reverse.

SKU	Description	UOM	Price
IRN701130	Anti-Blind Spot Dome Mirror, double sided tape	EA	\$53.65
IRN701140	Anti-Blind Spot Dome Mirror, magnet arm	EA	\$76.80



### E. Ergo Back-Up Handle

Reduce back strain with the Ergo Back-up Handle. Operators who are required to travel frequently in reverse often grab the overhead guard.

SKU	Description	UOM	Price
IRN701080	Ergo Handle with Horn ( Hard Wire)	EA	\$79.19
IRN701090	Ergo Handle with Built in Horn (Battery)	EA	\$140.20



**A**



### A. Safe-Bump Forklift Protectors

Specifically designed for forklifts, these bumpers reduce damage in many applications. Safe-Bump attaches with two 100 lb magnets and (VHB) two way tape.

SKU	Description	UOM	Price
IDL701110	Safe-Bump Forklift Protectors	EA	\$75.20

**B**



### B. Forklift Battery Protective Handling PPE Kit

Occupational Health and Safety laws require that all personnel wear personal protective equipment (PPE) when performing all battery maintenance or replacement. The PPE kit comes with everything needed to stay compliant and safe.

Forklift batteries contain sulphuric acid which is a hazardous material and the MSDS information requires personnel to wear particular PPE.

This complete forklift battery handling personal protective equipment kit mounts conveniently on any wall so that everything is within easy reach.

SKU	Description	UOM	Price
IDL701170	Forklift Battery Protective Handling PPE Kit	EA	\$157.03

### C. Forklift Battery Watering Gun

Keep your batteries properly filled and keep your battery tops dry by using our SFS watering gun. The forklift battery watering gun will help with the battery maintenance and care for your forklift battery. The front trigger battery watering gun safely and easily adds water to your industrial batteries. The gun automatically shuts off at the correct fill level every time. This gives an accurate cell fill every time without back strain or the risk of an acid splash.

SKU	Description	UOM	Price
IRN701180	Forklift battery watering gun	EA	\$130.43



**C**



**D**

### D. Dissipater Forklift Battery Cap

The Dissipater Battery cap makes battery maintenance easy with its revolutionary technology. It maximizes your forklift battery's potential and reduces watering intervals by returning 80% of the evaporated water back into the battery. Its ergonomic design and durable housing that is resistant against battery acid makes the Dissipater an effective battery maintenance tool. Use the Dissipater cap on all industrial batteries such as a forklift battery, lift truck battery, Aerial Work Platform battery and golf cart battery.

SKU	Description	UOM	Price
IRN701150	Dissipater forklift battery cap, yellow	EA	\$8.69





### A. Portable Safety Zone

The Portable Safety Zone design utilizes features representing the breakthrough in 'ease of use' barrier systems. It is lightweight and balanced for easy transportation by one operator and features a robust construction in 'safety orange' powder coated steel. The Portable Safety Zone comes complete with 100' safety orange fencing, 4 posts, 4 rubber base pads and 4 magnetic fence clips. The unique fence locking system ensures a sturdy fence assembly. Easily fits through 30" doorways, suitable for both indoor & outdoor applications on smooth surfaces.

SKU	Description	UOM	Price
IRN706030	Portable Safety Zone	EA	\$1056.25

### B. Trailer Lock Power Lever

The Trailer Lock Power Lever makes short work of stubborn container door handles that are difficult to move because of their small size and are often jammed, especially in snow and ice conditions. Just slip the tool over the door locking handles and easily use the extra leverage provided by the Trailer Lock Power Lever to open the doors. The extra leverage reduces operator strain and can help prevent injury. Additional safety is provided by the handle guard to help prevent scrapes and bruises. The Trailer Lock Power Lever can also be used as a "Tire Thumper" to check for adequate tire pressure.

SKU	Description	UOM	Price
IRN705000	Trailer Lock Power Lever	EA	\$205.07

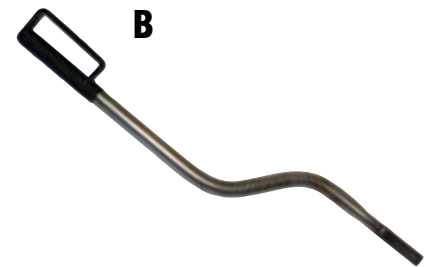

### C. Auto-Stand Plus

When fork-trucks load at the front of trailers, the trailer can become nose heavy and tip. This hazardous situation can be prevented by using Trailer Stands. The AutoStand Plus has unique features which make it user friendly, simple to move, and easy to operate, eliminating the need for strenuous motions required by other stands.

SKU	Description	UOM	Price
IRN605444	Auto-Stand Plus	EA	\$809.77

### D. Auto-Stand

When fork-trucks load at the front of trailers, the trailer can become nose heavy and tip. This hazardous situation can be prevented by using Trailer Stands. The Auto-Stand has Long and wide positioning handles with grips for easy positioning. Gas activated, self-leveling system with security pin.

SKU	Description	UOM	Price
IRN605452	Auto-Stand	EA	\$522.43



### E. Ratchet Top Stabilizing Jack

When fork-trucks load at the front of trailers, the trailer can become nose heavy and tip. This hazardous situation can be prevented by using Trailer Stands. Ratchet jack 100,000 lb. Static Load Capacity 8" diameter support pad.

SKU	Description	UOM	Price
IRN605453	Ratchet Top Stabilizing Jack	EA	\$284.81

## A. Barricade Construction Tag

Barricade construction tags allow workers to label a construction site by the dangers it presents. Come 25 per pack and with wire ties; made of vinyl.

SKU	Description	UOM	Price
MSS120	Barricade construction tag yellow, vinyl	25/PK	\$16.48



B

## B. Danger Tag

The blank danger tag warns workers to be alert and allows you to write the specific hazard on the card. Made of vinyl or cardstock and come 25 per pack.

SKU	Description	UOM	Price
MSS124	Danger tag-blank, vinyl	25/PK	\$16.48
MSS124-1	Danger tag-blank, cardstock	25/PK	\$7.10

## C. Scaffold Tags

Clearly label the safety of a scaffold using this daily inspection tags. Available in three colors and two durable materials.

SKU	Description	Type	Color	UOM	Price
MSS8137122R	Scaffold tags	Cardstock	Red	PK	\$7.10
MSS8137122G	Scaffold tags	Cardstock	Green	PK	\$7.10
MSS8137122Y	Scaffold tags	Cardstock	Yellow	PK	\$7.10
MSS136	Scaffold tags	Plastic	Red	PK	\$16.48
MSS135	Scaffold tags	Plastic	Green	PK	\$16.48
MSS137	Scaffold tags	Plastic	Yellow	PK	\$16.48

C



D

## D. Ladder Inspection Label

Make sure ladders are kept up to code with quarterly inspection labels that are color coded: White for 3/31, Green for 6/30, Red for 9/30 and Orange for 12/31.

SKU	Description	UOM	Price
MSS906	Ladder inspection labels- 3/31	EA	\$7.75
MSS907	Ladder inspection labels- 6/30	EA	\$7.75
MSS908	Ladder inspection labels- 9/30	EA	\$7.75
MSS909	Ladder inspection labels- 12/31	EA	\$7.75

## E. Medsafe® Equipment Tag

Tag equipment with the Medsafe name and contact number so that workers know who to contact for their safety needs. Inspection date provided on back.

SKU	Description	UOM	Price
MSS910	Medsafe equipment tag	EA	\$9.00

E





**A**

### A. Professional Carrying Case

This case is constructed of Lightweight NK-7™ resin, has a soft grip foldable handle and Powerclaw™ latching system. It is waterproof, impact resistant, crushproof and dustproof. Meets airline carry-on regulations.

SKU	Description	Ext. Dimensions	UOM	Price
PPC920MED	Professional carrying case	L16.7" x W13.4" x H6.8"	EA	\$116.32



### B. Allegro Fire Extinguisher Wall Case

Designed to protect fire extinguishers from dust and harsh workplace environments. Made of high-impact, corrosion resistant ABS. High-visibility red case make locating easy. Holds all major extinguishers up to 30 lbs size.

SKU	Description	UOM	Price
ALLE3100	Wall case	EA	\$289.47

**B**



**C**



ALLE4400

ALLE4500

### C. Respirator Storage Wall Case

Perfect for storing APRs, cartridges and other respirator accessories such as fit testing kits, storage bags and cleaning supplies. Exterior: 14"W x 9-1/2"D x 18"H. Interior: 12"W x 7-1/2"D x 16"H. Weight: 4 lbs.

SKU	Description	UOM	Price
ALLE4400	Respirator storage wall case, Ext: 14"W x 9-1/2"D x 18"H. Int: 12"W x 7-1/2"D x 16"H	EA	\$131.58
ALLE4500	Emergency respirator wall case, Ext: 14"W x 9-1/2"D x 21"H. Int: 12"W x 7-1/2"D x 19"H	EA	\$131.58

### D. AED Wall Cabinet

Metal case comes in corrosion resistant electro-static white finish. Defibrillator graphics are dominantly displayed. Other features include a 13" x 13" window on door front, right hand door opening and recessed handle. Also included is a battery operated alarm. Includes metal shelf. The 4210-S has a battery operated audio alarm and fully sealed water-proof strobe. Exterior: 20-1/4"W x 9-1/4"D x 20-1/4"H. Interior: 20-/18"W x 8-3/4"D x 20"H.

SKU	Description	UOM	Price
ALLE4210-01	AED wall cabinet small with alarm	EA	\$296.49

**D**







# Seasonal PPE



# COLD STRESS

## WORK/WARM-UP SCHEDULE

### FOR A 4 HR SHIFT



#### HOW TO USE THIS SCHEDULE:

- Across the top row, locate today's predicted wind speed.
- Down the left side, locate today's predicted air temperature.
- Follow across and down to find the recommended work time and warm-up/break-time in a four hour shift. Example: if the wind speed is 5 mph with an air temp of -20°F/29°C, workers shouldn't be outside for longer than 75 minutes at a time and should take a minimum of two, 10 minute breaks (warm-ups) in a heated area during a four-hour shift.



Limiting exposure to the cold is key in the prevention of cold stress. It's especially dangerous as temperatures lower and wind speed increases. Below is a work/warm-up schedule for workers based on the air temperature and wind speed of the environment:

AIR TEMPERATURE		NO NOTICEABLE WIND		5 MPH/8 KPH WIND		10 MPH/16 KPH WIND		15 MPH/24 KPH WIND		20 MPH/32 KPH WIND	
°C (approx.)	°F (approx.)	Maximum Work Period	Number of Breaks (>10 mins each)	Maximum Work Period	Number of Breaks (>10 mins each)	Maximum Work Period	Number of Breaks (>10 mins each)	Maximum Work Period	Number of Breaks (>10 mins each)	Maximum Work Period	Number of Breaks (>10 mins each)
-26° to -28°	-15° to -19°	(Normal Breaks) 1	(Normal Breaks) 1	(Normal Breaks) 1	(Normal Breaks) 1	75 min.	2	55 min.	3	40 min.	4
-29° to -31°	-20° to -24°	(Normal Breaks) 1	(Normal Breaks) 1	75 min.	2	55 min.	3	40 min.	4	30 min.	5
-32° to -34°	-25° to -29°	75 min.	2	55 min.	3	40 min.	4	30 min.	5	EMERGENCY WORK ONLY	
-35° to -37°	-30° to -34°	55 min.	3	40 min.	4	30 min.	5				
-38° to -39°	-35° to -39°	40 min.	4	30 min.	5	EMERGENCY WORK ONLY	EMERGENCY WORK ONLY				
-40° to -42°	-40° to -44°	30 min.	5	EMERGENCY WORK ONLY	EMERGENCY WORK ONLY						
-43° & below	-45° & below	EMERGENCY WORK ONLY				EMERGENCY WORK ONLY		EMERGENCY WORK ONLY		EMERGENCY WORK ONLY	

\*Source: Adapted from Threshold Limit Values (TLV) and Biological Exposure Indices (BEI) booklet: published by ACGIH, Cincinnati, Ohio, 2008



### A. Carhartt® FR 6.75 oz 88/12 Midweight Active Jacket/Quilt-Lined

Carhartt's flame-resistant midweight active jacket is finished with a 6.75-ounce quilt lining for warmth. Made of 8.5-ounce, flame-resistant canvas, a blend of 88% cotton and 12% high-tenacity nylon, it features two lower front pockets, two inside patch pockets with FR hook-and-loop closure for arc protection. It also has Nomex® FR rib-knit cuffs and waistband and brass zipper with Nomex® zipper tape. **CAT 3, NFPA 70E compliant.**

SKU	Colors	Sizes								UOM
CTJ237BD	Brown	S	M	L	XL	2X	3X	4X	EA	
<b>Price</b>		\$200.18	\$215.79	\$215.79	\$215.79	\$215.79	\$245.61	\$245.61		
CTJ237DN	Navy	S	M	L	XL	2X	3X	4X	EA	
<b>Price</b>		\$200.18	\$215.79	\$215.79	\$215.79	\$215.79	\$245.61	\$245.61		

\*Contact customer service for pricing and availability on tall sizes.



**CAT 3**  
NFPA 70E

**CAT 4**  
NFPA 70E



**B**

### B. Carhartt® FR 8.5 oz Cotton Active Jacket/Quilt-Lined

Made in the USA, Carhartt's flame-resistant duck active jac is a combination of durability, comfort and protection. Made of 13-ounce, flame-resistant 100% cotton duck, it is quilt-lined and features two inside patch pockets with flame-resistant hook-and-loop closures, Nomex® rib-knit cuffs and waistband and a brass front zipper with Nomex® zipper tape and hidden snap closure for electric arc protection. **CAT 4, NFPA 70E compliant.**

SKU	Colors	Sizes								UOM
CTJ184BRN	Brown	S	M	L	XL	2X	3X	4X	EA	
<b>Price</b>		\$206.69	\$206.69	\$206.69	\$206.69	\$206.69	\$234.36	\$234.36		
CTJ184DNY	Navy	S	M	L	XL	2X	3X	4X	EA	
<b>Price</b>		\$206.69	\$206.69	\$206.69	\$206.69	\$206.69	\$234.36	\$234.36		
CTJ184BLK	Black	S	M	L	XL	2X	3X	4X	EA	
<b>Price</b>		\$206.69	\$206.69	\$206.69	\$206.69	\$206.69	\$234.36	\$234.36		

\*Contact customer service for pricing and availability on tall sizes.

### C. Carhartt® FR 13 oz Cotton Duck Bomber Jacket/Quilt-Lined

Carhartt's flame-resistant duck bomber quilt-lined jacket will keep you warm in cooler weather. Made of 13-ounce, 100% cotton flame-resistant duck with a 10.5-ounce flame-resistant quilt lining, it has two inside patch pockets with flame resistant hook-and-loop closure for convenient storage and Nomex® rib-knit cuffs and waistband. It also features a brass front zipper with Nomex® zipper tape that has inside and outside protective flaps and hidden snap closure for electric arc protection. An optional flame-resistant hood can be attached with snaps under the collar. **CAT 4, NFPA 70E compliant.**

SKU	Colors	Sizes									UOM
CTJ195BR	Brown	S	M	L	XL	2X	3X	4X	5X	EA	
<b>Price</b>		\$190.41	\$190.41	\$190.41	\$190.41	\$190.41	\$216.45	\$216.45	\$216.45		
CTJ195DNY	Navy	S	M	L	XL	2X	3X	4X	5X	EA	
<b>Price</b>		\$190.41	\$190.41	\$190.41	\$190.41	\$190.41	\$216.45	\$216.45	\$216.45		

\*Contact customer service for pricing and availability on tall sizes.



**CAT 4**  
NFPA 70E

**CAT 2**  
NFPA 70E



**D**

### D. Carhartt® FR 8.5 oz 88/12 All-Season Bomber Jacket

Carhartt's flame-resistant all-season bomber jacket is designed to last. Made of 8.5-ounce flame-resistant canvas, a blend of 88% cotton and 12% high-tenacity nylon, it features a 6-ounce twill face cloth lining. It also has two lower front pockets, two inside pockets with FR hook-and-loop closure for arc protection, Nomex® FR rib-knit cuffs and waistband and brass zipper with Nomex® zipper tape. **Meets NFPA 70E standard.**

SKU	Colors	Sizes									UOM
CTJ020BRN	Brown	S	M	L	XL	2X	3X	4X	5X	EA	
<b>Price</b>		\$172.51	\$172.51	\$172.51	\$172.51	\$172.51	\$198.55	\$198.55	\$198.55		
CTJ020DNY	Navy	S	M	L	XL	2X	3X	4X	5X	EA	
<b>Price</b>		\$172.51	\$172.51	\$172.51	\$172.51	\$172.51	\$198.55	\$198.55	\$198.55		

\*Contact customer service for pricing and availability on tall sizes.







**A**

**CAT 4**

**NFPA 70E**



### A. Carhartt® FR 13 oz Cotton Duck Traditional Coat/Quilt-Lined

Protect yourself from flash fire or electric arcs on the job. Carhartt's flame-resistant duck traditional coat is quilt-lined and made of 13-ounce flame-resistant, 100% cotton duck. It features two inside patch pockets with flame-resistant hook-and-loop closures, Nomex® inside-waist drawcord for an adjustable fit, rib-knit storm cuffs to seal out cold air, a two-way brass zipper and snaps under the collar for an optional hood (FRA265). **It is NFPA 70E compliant.**

SKU	Colors	Sizes							UOM
CTC066BRN	Brown	S	M	L	XL	2X	3X	4X	EA
<b>Price</b>		\$209.94	\$209.94	\$209.94	\$209.94	\$209.94	\$235.98	\$235.98	
CTC066DNY	Navy	S	M	L	XL	2X	3X	4X	EA
<b>Price</b>		\$209.94	\$209.94	\$209.94	\$209.94	\$235.99	\$235.98	\$235.98	
CTC066BLK	Black	S	M	L	XL	2X	3X	4X	EA
<b>Price</b>		\$209.94	\$209.94	\$209.94	\$209.94	\$209.94	\$235.98	\$235.98	
CTC066STL	Steel	S	M	L	XL	2X	3X	4X	EA
<b>Price</b>		\$209.94	\$209.94	\$209.94	\$209.94	\$209.94	\$235.98	\$235.98	

\*Contact customer service for pricing and availability on tall sizes.

### B. Carhartt® FR 13 oz Cotton Duck Hood/Quilt-Lined

Supplement your protective FR gear with this comfortable, quilt-lined hood. Made of 13-ounce, flame-resistant 100% cotton duck, the 10.5-ounce quilt lining will keep you warm on the coldest workdays. It features a three-piece hood and a Nomex® drawcord. **CAT 4, NFPA 70E compliant.**

SKU	Description	Color	UOM	Price
CTFRA265NVY	Hood/Quilt Lined FR 13 oz Cotton Duck Used With CTC066/CTJ195	Navy	EA	\$47.19
CTFRA265RYL	Hood/Quilt Lined FR 13 oz Cotton Duck Used With CTC066/CTJ195	Royal	EA	\$47.19
CTFRA265BRN	Hood/Quilt Lined FR 13 oz Cotton Duck Used With CTC066/CTJ195	Brown	EA	\$47.19
CTFRA265BLK	Hood/Quilt Lined FR 13 oz Cotton Duck Used With CTC066/CTJ195	Black	EA	\$47.19
CTFRA265STL	Hood/Quilt Lined FR 13 oz Cotton Duck Used With CTC066/CTJ195	Steel	EA	\$47.19



**B**

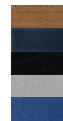

**CAT 4**

**NFPA 70E**



**C**

**CAT 3**

**NFPA 70E**



### C. Carhartt® 14.25 oz FR Thermal-Lined Sweatshirt

Carhartt's heavyweight, 14.25-ounce, FR knit is a 58% cotton/35% modacrylic/7% polyester blend with a Rain Defender™ durable water-repellent finish. The thermal lining is no slouch either: 7-ounce, FR knit of 55% modacrylic/45% cotton. It features stretchable, spandex-reinforced rib-knit cuffs and waistband, a three-piece thermal-lined hood, brass front-zipper with Nomex® FR zipper tape plus inner and outer protective flaps, two front hand-warmer pockets, and an inside patch pocket. Carhartt FR and CAT 3 labels are sewn on the left-front pocket. **Meets NFPA 70E standards.**

SKU	Colors	Sizes							UOM	
CTS647NVY	Navy	S	M	L	XL	2X	3X	4X	5X	EA
<b>Price</b>		\$229.67	\$229.67	\$229.67	\$229.67	\$229.67	\$266.03	\$266.03	\$266.03	

\*Contact customer service for pricing and availability on tall sizes.

### D. Carhartt® 8.5 oz FR 88/12 Canvas Shirt Jac

Carhartt's easiest-wearing, hardest-working 8.5-ounce, FR canvas shirt jac features 88% cotton/12% high-tenacity nylon and a twill lining. You'll find antique-finish brass snaps, two chest pockets with rivet reinforcements for durability, and adjustable two-snap cuffs with extended plackets. Carhartt FR and CAT 3 labels are sewn on the left pocket. **Meets the performance requirements of NFPA 70E standards and is UL® Classified to NFPA 2112.**

SKU	Colors	Sizes							UOM
CTS432201	Brown	S	M	L	XL	2X	3X	4X	EA
<b>Price</b>		\$96.02	\$96.02	\$96.02	\$96.02	\$96.02	\$110.67	\$110.67	
CTS432001	Black	S	M	L	XL	2X	3X	4X	EA
<b>Price</b>		\$96.02	\$96.02	\$96.02	\$96.02	\$96.02	\$110.67	\$110.67	

\*Contact customer service for pricing and availability on tall sizes.



**D**

**CAT 2**

**NFPA 2112  
NFPA 70E**



### A. Carhartt® 14 oz FR Heavyweight Zip-Front Hooded Sweatshirt

Carhartt's heavyweight zip-front sweatshirt is now available in flame-resistant fabric. Made of heavyweight flame-resistant 14-ounce knit, 58% cotton/35% modacrylic/7% polyester, it features an attached hood and FR draw cord closure and two front handwarmer pockets. A Carhartt FR and CAT 3 labels are sewn on the left-front pocket. **CAT 3, NFPA 70E compliant.**

SKU	Colors	Sizes								UOM
CTFRK007N	Navy	S	M	L	XL	2X	3X	4X	5X	EA
<b>Price</b>		\$149.73	\$149.73	\$149.73	\$149.73	\$149.73	\$166.00	\$154.61	\$154.61	

\*Contact customer service for pricing and availability on tall sizes.

A



CAT 3  
NFPA 70E

CAT 3  
NFPA 70E



B

### B. Carhartt® 14 oz FR Heavyweight Hooded Sweatshirt

When cold weather is in the forecast, reach for Carhartt's flame-resistant heavyweight hooded sweatshirt for warmth. It's constructed of heavyweight, flame-resistant 14-ounce knit, 58% cotton/35% modacrylic/7% polyester. For added comfort, it features an attached hood with adjustable draw-cord closure, and a front hand-warmer pocket. Anti-odor control is also included. **Meets NFPA 70E standards.**

SKU	Colors	Sizes								UOM
CTK006N	Navy	S	M	L	XL	2X	3X	4X	5X	EA
<b>Price</b>		\$135.08	\$135.08	\$135.08	\$135.08	\$135.08	\$146.47	\$146.47	\$146.47	

\*Contact customer service for pricing and availability on tall sizes.

### C. Carhartt® 13 oz FR Cotton Duck Quilt Lined Bib Overall

Add warmth to your workwear with our flame-resistant duck bib overalls. Made of 13-ounce, flame-resistant 100% cotton duck, it features a quilt lining, a high back with flame-resistant elastic suspenders and high temperature nylon center-release buckles. They also have a chap-style double front for durability, flame-resistant melamine button at waist, multiple tool and utility pockets, ankle-to-mid-thigh brass leg zippers with Nomex® zipper tape and protective flaps and arc-resistant snap closures. **NFPA 70E compliant.**

SKU	Colors	Size: Waist		UOM
CTFRR44D	Navy	30-50	52-54	EA
<b>Price</b>		\$242.49	\$265.28	
CTFRR44B	Brown	30-48	50-54	EA
<b>Price</b>		\$242.49	\$265.28	

C



CAT 4  
NFPA 70E

CAT 2  
NFPA 2112  
NFPA 70E



D

### D. Flame-Resistant 9 oz Cotton Insulated Coverall

Insulated coverall is made out of 9 oz flame-resistant, 100% cotton fabric. Sewn through-out with Nomex® thread. All stress points are bar-tacked for reinforcement. Lay-down collar, six pockets, pencil slot on left chest pocket and red FR tag on chest pocket. Snaps on pass-through pockets, double-layer rear pockets, and two-ply rear pocket bottom. Heavy duty (two-way) Nomex, brass zipper, and zipper flap with snap. Sewn bi-swing back, elastic waist-in back, reinforced waistband in front, and finished dress cuff with adjustable snap closure. Insulated for added warmth. Permanent label lists washing instructions, size, fiber content and RN#. Made in USA. Available in navy blue, royal blue and tan. **Complies with NFPA 70E (CAT 2) and NFPA 2112 standards.**

SKU	Colors	Sizes*								UOM
INDIJS16	Tan	S	M	L	XL	2X	3X	4X	5X	EA
<b>Price</b>		\$201.75	\$201.75	\$201.75	\$201.75	\$211.84	\$222.42	\$233.53	\$245.19	
INDIJSNB	Navy	S	M	L	XL	2X	3X	4X	5X	EA
<b>Price</b>		\$201.75	\$201.75	\$201.75	\$201.75	\$211.84	\$222.42	\$233.53	\$245.19	
INDIJSRB	Royal	S	M	L	XL	2X	3X	4X	5X	EA
<b>Price</b>		\$201.75	\$201.75	\$201.75	\$201.75	\$211.84	\$222.42	\$233.53	\$245.19	

\*Contact customer service for pricing and availability on short and tall sizes.





**CAT 3**

NFPA 2112  
NFPA 70E



**A**

### A. Bomber Jacket - EXCEL FR® ComforTouch®

Lined Bomber Jacket - EXCEL FR® ComforTouch® features separating, heavy-duty, Nomex® taped brass zipper, fully covered with two-layer storm flap, concealed snap closure, two-layer stand-up collar, concealed snap closure on cuff, two large external patch pockets with concealed snap closure, with hand warmer, one inside chest pocket, deep-pleated action back, fully-tunneled elasticized waistband, inside zipper guards on all zippers, accommodates snap-on hood BWKHLH2NV, sold separately and accommodates liners BWKLN2NV, sold separately.

Fabric - Outershell: EXCEL FR® ComforTouch® Flame-resistant 7 oz. Twill, 88% Cotton / 12% Nylon, Water-repellant. Liner: Flame-resistant 7 oz. 100% Cotton.

Care - Home Wash and Industrial Wash

Protection - CAT 3, NFPA 70E and NFPA 2112 compliant.

SKU	Colors	Sizes							UOM
BWKJLJ8NV	Navy Blue	S	M	L	XL	2X	3X	4X	EA
<b>Price</b>		\$150.64	\$150.64	\$150.64	\$150.64	\$180.76	\$180.76	\$180.76	
BWKLNL2NV	Navy Blue	S	M	L	XL	2X	3X	4X	EA
<b>Price: Jacket Liner</b>		\$151.87	\$151.87	\$151.87	\$151.87	\$182.24	\$182.24	\$182.24	
BWKHLH2NV	Navy Blue	One Size							EA
<b>Price: Hood</b>		\$43.48							

### B. Parka - EXCEL FR® ComforTouch®

Parka - EXCEL FR® ComforTouch® features two-way, separating, heavy-duty nomex®, taped brass zipper, fully covered with insulated storm flap, concealed snap closure, fully insulated stand-up collar, knit storm cuff with hook-and-loop suppression tabs, three large patch pockets with concealed snaps (lower pocket with handwarmers), one inside chest pocket, sleeve pocket, deep-pleated action back, elastic inserts at waist across back, internal snow belt and accommodates snap-on hood BWKHLH2NV, sold separately.

Fabric - Outershell: EXCEL FR® ComforTouch® Flame-resistant 7 oz. Twill 88% Cotton / 12% Nylon, Water Repellant. Insulation: Flame-resistant 12 oz. Two-layer Quilted Modacrylic.

Care - Home Wash and Industrial Wash

Protection - CAT 4, NFPA 70E and NFPA 2112 compliant.

SKU	Colors	Sizes							UOM
BWKJLP8NV	Navy Blue	S	M	L	XL	2X	3X	EA	
<b>Price</b>		\$217.04	\$217.04	\$217.04	\$217.04	\$260.44	\$260.44		
BWKHLH2NV	Navy Blue	One Size						EA	
<b>Price: Hood</b>		\$43.48							



**B**

**CAT 4**

NFPA 2112  
NFPA 70E

**CAT 4**

NFPA 2112  
NFPA 70E



**C**

### C. Parka - Nomex® IIIA

The Parka - Nomex® IIIA features two-way, separating, extra heavy-duty nomex®, taped brass zipper, fully covered with insulated storm flap, hook-and-loop secured, fully insulated stand-up collar, knit storm cuff within hemmed sleeve end with hook-and-loop suppression tabs, three large external patch pockets with hook-and-loop secured flaps (lower pockets with hand warmers), one inside chest pocket, sleeve pocket, deep-pleated action back, elastic inserts at waist across back, inside zipper guards on all zippers, internal snow belt and accommodates snap-on hood BWKHNH2NV, sold separately.

Fabric - Outershell: Flame-resistant, 6 oz. Water Repellant Nomex® IIIA (93% Nomex® Aramid / 5% Kevlar® Aramid / 2% Other Fiber). Insulation: Flame-resistant 14.2 oz. Quilted Nomex® with Wind and Moisture Barrier.

Care - Home Wash and Light Soil Wash

Protection - CAT 4, NFPA 70E and NFPA 2112 compliant.

SKU	Colors	Sizes							UOM
BWKJNP2NV	Navy Blue	S	M	L	XL	2X	3X	EA	
<b>Price</b>		\$352.45	\$352.45	\$352.45	\$352.45	\$422.93	\$422.93		
BWKHNH2NV	Navy Blue	One Size						EA	
<b>Price: Hood</b>		\$57.41							





**CAT 4**  
NFPA 2112  
NFPA 70E

### A. 2112® 7 oz FR 88/12 Bomber Jacket

The 2112 Bomber Jacket features an outer shell made of 7 oz. 88% cotton, 12% nylon fabric, 100% cotton liner, heavy duty brass zipper fully covered with storm flap and concealed Velcro closure, stand-up collar with optional Velcro hood attachment, Velcro sleeve closures, 2 combination cargo/slash pockets, 1 Internal cell phone pocket and a D-Ring pass-through. Available in sizes small up to 5X-large. 3rd party, North American, UL tested. **Complies with NFPA 70E, CAT 2 and NFPA 2112 standards.**

SKU	Colors	Sizes								UOM
FRJKTNVY	Navy Blue	S	M	L	XL	2X	3X	4X	5X	EA
<b>Price</b>		\$165.00	\$165.00	\$165.00	\$165.00	\$165.00	\$181.00	\$189.15	\$191.15	

**CAT 4**  
NFPA 2112  
NFPA 70E



### B. 2112® 7 oz FR 88/12 Parka

The 2112 Parka features an outer shell made of 7 oz. 88% cotton, 12% nylon fabric, 100% cotton liner, heavy duty brass zipper fully covered with storm flap and concealed Velcro closure, stand-up collar with optional Velcro hood attachment, Velcro sleeve closures, 2 combination cargo/slash pockets, 1 Internal cell phone pocket and a D-Ring pass-through. Available in sizes small up to 5X-large. 3rd party, North American, UL tested. **Complies with NFPA 70E, CAT 2 and NFPA 2112 standards.**

SKU	Colors	Sizes								UOM
FRPKANVY	Navy Blue	S	M	L	XL	2X	3X	4X	5X	EA
<b>Price</b>		\$191.15	\$191.15	\$191.15	\$191.15	\$191.15	\$210.25	\$220.00	\$230.00	

### C. FR 9 oz Cotton Jacket with Zip-In Liner

This 100% cotton FR jacket containing flame resistant properties are guaranteed for the life of the garment if proper laundering instructions are followed. This banded waist-style "ike" jacket features two slant front pockets, zipper front closure and zipper for zip-in double-faced modaquit liner. Permanent label lists washing instructions and size. Made in USA. Available in royal blue, tan and navy blue. Specify size S - 5XL. **CAT 2, NFPA 70E and NFPA 2112 compliant.**

SKU	Colors	Sizes						UOM
INDJKTKH	Tan	S	M	L	XL	2X	3X	EA
<b>Price</b>		\$164.91	\$164.91	\$164.91	\$164.91	\$173.16	\$181.82	
INDJKTGRY	Grey	S	M	L	XL	2X	3X	EA
<b>Price</b>		\$164.91	\$164.91	\$164.91	\$164.91	\$173.16	\$181.82	
INDJKTNVY	Navy Blue	S	M	L	XL	2X	3X	EA
<b>Price</b>		\$164.91	\$164.91	\$164.91	\$164.91	\$173.16	\$181.82	



**CAT 2**  
NFPA 2112  
NFPA 70E

**CAT 1**  
NFPA 2112  
NFPA 70E



### D. DuPont™ Nomex® IIIA Jacket with Zip-In Liner

Nomex IIIA Aramid is inherently flame resistant for the life of the garment. The flame resistant properties will not wash or wear out. This banded waist-style "ike" jacket features two slant front pockets, zipper front closure and 6.0 oz. Nomex with zipper for zip-in double-faced modaquit liner. Permanent label lists washing instructions and size. Made in USA. Available in royal blue, spruce green, gray, tan, orange and navy blue. Specify size S - 5XL. **CAT 1, NFPA 70E and NFPA 2112 compliant.**

SKU	Colors	Sizes						UOM
NOMJKTGH	Tan	S	M	L	XL	2X	3X	EA
<b>Price</b>		\$228.07	\$228.07	\$228.07	\$228.07	\$239.47	\$251.46	
NOMJKTGREY	Grey	S	M	L	XL	2X	3X	EA
<b>Price</b>		\$228.07	\$228.07	\$228.07	\$228.07	\$239.47	\$251.46	
NOMJKTNVY	Navy Blue	S	M	L	XL	2X	3X	EA
<b>Price</b>		\$228.07	\$228.07	\$228.07	\$228.07	\$239.47	\$251.46	
NOMJKTROY	Royal Blue	S	M	L	XL	2X	3X	EA
<b>Price</b>		\$228.07	\$228.07	\$228.07	\$228.07	\$239.47	\$251.46	





**A**

### A. Hi-Viz Class 3 Parka 3-In-1 Weatherproof

The Radians SJ41 Class 3, three-in-one weatherproof parka features a wind and water resistant shell and removable inner fleece jacket. It also features a 2" silver reflective tape and mic tabs on both shoulders. Four lower, fleece lined pockets with zipper, fleece lined chest pocket, hidden inside side pocket, two large inside pockets, concealed hood, pass through on back for fall protection and wrist cuffs with closure.

SKU	Description	UOM	Price
MSCSJ41G	Hi-Viz class 3 parka 3-in-1 weatherproof	EA	\$95.00

### B. Bomber Jacket Hi-Viz Class 3 with Zip-Out Removable Jacket

Three-In-One Deluxe Bomber Jacket with zip out removable jacket. This class 3/level 2 bomber jacket features a PU coated polyester shell, fleece lined chest pocket, clear chest badge holder, concealed detachable hood, cell phone/radio chest pocket, mic tabs on both shoulders and two left sleeve pencil pockets. It has a yellow elasticized waistband, elasticized cuffs with closure and 2" silver reflective tape. Meets ANSI /ISEA 107-2004 standards.

SKU	Description	Color	UOM	Price
MSCSJ21G	Bomber jacket hi-viz class 3 with zip-out removable jacket	Green	EA	\$57.93
MSCSJ21O	Bomber jacket hi-viz class 3 with zip-out removable jacket	Orange	EA	\$57.93



**B**



**C**

### C. Long Sleeve Hooded Sweatshirt Class 3

Radians SJ01-3 Class 3 Long Sleeve Hooded Sweatshirt offers superior warmth while keeping you visible. Hood is lined with double, birds-eye mesh to maximize airflow and quickly dry moisture. This sweatshirt also features a black elastic knit waistband and cuffs, 2" silver reflective tape, full front zipper closure, two lower pouch pockets and mesh lined hood with adjustable pull cords. 3rd Party Certified – Meets ANSI/ISEA 107-2010 Standards.

SKU	Description	Color	UOM	Price
MSCSJ013ZGS	Sweatshirt with hood, class 3, hi-vis	Green	EA	\$38.00
MSCSJ013ZOS	Sweatshirt with hood, class 3, hi-vis	Orange	EA	\$38.00

### D. Long Sleeve Polo Class 2 Hi-Viz

This safety Polo is made with an arid Birdseye Mesh allowing for maximum breathability, without compromising durability. The stripes are adhered by heat transfer rather than sewn on, making the safety Polo extremely comfortable. The wicking properties improve hot weather comfort making it feel much cooler. The front pocket does not include reflective material to allow for corporate imprints. 3rd Party Certified – Meets ANSI/ISEA 107-2010 Standards.

SKU	Description	Color	Size	UOM	Price
MSCST222G	Long sleeve polo class 2 hi-viz	Lime	M-5X	EA	\$20.62
MSCST222O	Long sleeve polo class 2 hi-viz	Orange	M-5X	EA	\$20.62



**D**



**A. N-FERNO™ 6840 & 6842 Cool Series Winter Liner**

Regular and shoulder length winter liners with a hook and loop chin strap. The shell is made of 100% polyester with PU coating while the lining is 100% poly fleece. Features an elastic gap control at forehead keeps warmth in and cold out. Water repellent.

SKU	Description	UOM	Price
ERGW6840	Winter liner- 2 layer	EA	\$3.74
ERGW6842	Winter liner- 2 layer shoulder length	EA	\$6.34



**B. N-FERNO™ 6850 & 6852 2-Layer Winter Liner**

The 6850 & 6852 are made with a 100% cotton twill shell and a lining of 100% poly fleece. Elastic gap control at forehead and hook and loop chinstrap keeps warmth in and cold out. Also equipped with warming pack pockets near ears for extra warmth.

SKU	Description	Color	UOM	Price
ERGW6850	Winter liner, 2-Layer - regular	Black/red	EA	\$5.69
ERGW6852	Winter liner, 2-Layer - shoulder	Black/red	EA	\$8.62



**C. N-FERNO™ 6863 & 6867 3-Layer Winter Liner**

The 6863 & 6867 3-Layer Extreme Series Winter Liner have a shell made of 100% quilted nylon with a mid-layer of foam and an inside lining of 100% poly fleece. Elastic gap control at forehead and hook and loop chinstrap keeps warmth in and cold out. Also equipped with warming pack pockets near ears for extra warmth.

SKU	Description	Color	UOM	Price
ERGW6863	Winter liner, 3-Layer - regular	Black/red	EA	\$5.37
ERGW6867	Winter liner, 3-Layer - shoulder	Black/red	EA	\$7.56



**D. N-FERNO™ 6950 & 6952 3-Layer Winter Liners**

The 6950 & 6952 is shoulder length with a shell of 100% quilted nylon with a mid-layer of foam and an inside lining of 100% poly sherpa. Elastic gap control at forehead and hook and loop chinstrap keeps warmth in and cold out. Also equipped with warming pack pockets near ears for extra warmth.

SKU	Description	Color	UOM	Price
ERGW6950	3-Layer winter liner with sherpa - regular	Black/white	EA	\$7.07
ERGW6952	3-Layer winter liner with sherpa - shoulder	Black/white	EA	\$9.60





ERGW6862



ERGW6860

**A**

### A. N-FERNO™ 6860 & 6862 2-Layer FR Winter Liner w/Banox Shell

The 6860 & 6862 2-Layer Cold Series Winter Liner is constructed of a 2-layer Banox FR3-cotton/fleece. The Banox FR3® Fabric shell lasts up to 50 washings and the lining is 100% poly fleece. Elastic gather at forehead and warming pack pockets.

SKU	Description	Color	UOM	Price
ERGW6860	Winter liner, 2-Layer, Proban - regular	Black/red	EA	\$10.49
ERGW6862	Winter liner, 2-Layer, Proban - shoulder	Black/red	EA	\$17.98

### B. N-Ferno® 6880 & 6882 2-Layer FR Winter Liner

The 6860 & 6862 2-Layer Cold Series Winter Liner consist of a 2-layer Banox/Modacrylic fleece construction and Banox FR3® shell ( ATPV rating of 9.4 cal/cm2). The lining is Modacrylic fleece (EBT rating of 9.6 cal/cm2). Meets requirements of Performance Specification ASTM F1506; classified CAT2 according to NFPA 70E. They also feature an elastic gather at forehead, Hook and Loop straps for easy attachment and warming pack pockets.

SKU	Description	UOM	Price
ERGW6880	Winter liner, FR two layer - regular	EA	\$23.35
ERGW6882	Winter liner, FR two layer - shoulder	EA	\$36.45



ERGW6880



ERGW6880

**B**



**C**

### C. N-Ferno® 6885 Two-layer FR Winter Liner

The N-Ferno® 6885 Two-layer FR Winter Liner has a versatile design with detachable upper and lower sections to provide the ultimate in winter and FR protection. The upper section is Banox FR3® Shell( ATPV rating of 9.4 cal/cm2) with Modacrylic fleece lining (EBT rating of 9.6 cal/cm2). The lower section Double layer modacrylic blend rib knit (EBT rating of 17.0 cal/cm2). It also features a Nomex® Metal Zipper, hook and Loop straps for easy attachment and warming pack pockets. Meets requirements of Performance Specification ASTM F1506; classified CAT2 according to NFPA 70E.

SKU	Description	UOM	Price
ERGW6885	Winter liner, FR two-layer	EA	\$44.75

### D. N-FERNO™ 6870 Cold Series Removable Mouth Piece

Cold series 2-layer removable mouth piece can be used with the cold series liners. Made with a shell of 100% cotton twill and a lining of 100% poly fleece. FR treated for safety. Hook and loop closure secures to liner.

SKU	Description	Color	UOM	Price
ERGW6870	2-Layer winter liner with mouth piece	Black/red	EA	\$3.01



**D**



A



**A. N-FERNO™ 6821 Cool Series Balaclava**

Long length for extra protection from the cold and wind on winter days. Made of comfortable polyester fleece.

SKU	Description	Color	UOM	Price
ERGW6821	Balaclava winter liner	Black	EA	\$5.12

B



**B. N-Ferno® 6825 Nomex Balaclava**

The N-Ferno® 6825 Stretchable Nomex fleece keeps head and neck comfortable while providing FR protection with an ATPV value of 9.7 (CAT 2).

SKU	Description	UOM	Price
ERGW6825	Balaclava, FR Nomex, fleece	EA	\$46.95

C



**C. N-FERNO™ 6810 Stretch Tube Winter Liner**

Cool series stretch tube winter liner is FR treated for safety. Made of 100% polyester knit.

SKU	Description	Color	UOM	Price
ERGW6810	Stretch tube winter liner	Black	EA	\$5.37

D



**D. N-FERNO™ 6815 Full-Face Winter Liner**

Full-face style stretch tube winter liner is FR treated for safety. Made of 100% polyester knit.

SKU	Description	Color	UOM	Price
ERGW6815	Full-face winter line	Black	EA	\$8.86

E



**E. Chill-Its® 6990 Warming Packs**

Just break the pack to activate the heating action. Insert in winter liner ear pockets for up to 10 hours of warmth. Sold in pairs.

SKU	Description	UOM	Price
ERGW6990	Winter liner - warm packs	PR	\$1.22



**A**

■ HexArmor Protection Zone - ISEA CUT:5 CE 4543  
 ■ Impact Protection

### A. HexArmor® GGT5® Arctic Gator® 4031

The synthesis of the most advanced HexArmor® technologies shouldn't only be available at room temperature. That's why HexArmor® took the industry's highest level of cut protection and impact resistance, combined them, and then added layers of Hipora® and C40 Thinsulate™. Now your gloves can combat challenging conditions while your hands stay safe. The GGT Arctic Gator™ 4031 gives you Level 5 cut protection on the palm and fingers, with an additional reinforcing layer of TP-X™ technology for high grip and durability. The Hi-Vis back-of-hand supports our IR-X™ impact-resistant exoskeleton, so your entire hand is guarded from smash injuries down to each knuckle. All of this was achieved while maintaining the highest movement allowance, so your dexterity is preserved, and you can face the cold with confidence.

SKU	Description	Size	UOM	Price
HEX4031	GGT5 Arctic Chill	S-XL	PR	\$60.42
HEX40312X	GGT5 Arctic Chill	2X	PR	\$68.84

### B. Rig Lizard Arctic® TP-X+® Palm 2026

The Rig Lizard Arctic® 2026 uses a C100 Thinsulate™ liner to provide maximum warmth, while our H2X® liner creates a waterproof barrier for your hands. And to make this the most well-rounded winter work glove available, we added a durable and abrasion resistant TP-X+® palm for maintaining grip in both wet and dry situations.

SKU	Description	Size	UOM	Price
HEX2026	Rig Lizard Arctic® TP-X+® Palm	S-XL	PR	\$49.06
HEX20262X	Rig Lizard Arctic® TP-X+® Palm	2X	PR	\$55.10
HEX20263X	Rig Lizard Arctic® TP-X+® Palm	3X	PR	\$55.10



■ HexArmor Protection Zone - ISEA CUT:4 CE 4343  
 ■ Impact Protection



**C**

■ HexArmor Protection Zone - ISEA CUT:3 CE 4244  
 ■ Impact Protection

### C. HexArmor® Rig Lizard Arctic™ 2023

The Rig Lizard Arctic™ 2023, with ANSI Cut Level 3 protection, which provides the greatest comfort and range of motion you will get from a thermal rig and mining glove. These features supplement the industry's most advanced impact-resistant exoskeleton, and a synthetic grip, creating the new standard for a cold-weather oil and gas protective glove.

SKU	Description	Size	UOM	Price
HEX2023	Rig Lizard Arctic™ Glove	S-2X	PR	\$40.42



### D. ProFlex® 925F(x)OD Thermal Dorsal Impact-Reducing Gloves

Thermal Waterproof Dorsal Impact-Reducing Gloves w/ OutDry®: the warmest, driest, dorsaliest protectionist gloves available featuring revolutionary OutDry® Waterproofing Technology and 100g 3M™ Thinsulate™ insulation.

SKU	Description	Size	UOM	Price
ERG925FXOD	PRoFlex® Gloves, dorsal impact reducing, thinsulate lined	XS-3X	PR	\$74.66



**D**





**A. R2 Winter Fleece Orange**

R2 Winter Glove has 4 way stretch spandex in back of hand, Parity™ synthetic leather palm with Clarino™ palm and finger patches, TPR knuckle, finger and back of hand protection, Kevlar® reinforced thumb saddle, Parity™ synthetic forchettes, oil resistant palm with silicone pattern that provides excellent grip, fleece lining for warmth, waterproof Enprotex® lining, ID tag on cuff to place name to protect investment, neoprene extended safety cuff with spandex for added comfort.

SKU	Description	Size	UOM	Price
WCHE86711	R2 winter fleece orange	M-2X	PR	\$32.55



**B. Driver Glove Hi-Vis Lined**

Select grain cowhide leather driver glove. 100g Thinsulate lining. Extra protection by keeping safety in mind with Hi-Vis orange at the fingertips and a Hi-Vis reminder to “WATCH YOUR HANDS”. Keystone thumb is durable and allows for the best flexibility. Shirred elastic wrist.

SKU	Description	Size	UOM	Price
WCHE990KTT	Driver glove, hi-vis, lined	S-L	DZ	\$123.82
WCHE990KTTXL	Driver glove, hi-vis, lined	XL	DZ	\$126.94
WCHE990KTT2X	Driver glove, hi-vis, lined	2X	DZ	\$133.58



**C. Premium Grain Pigskin Hi-Vis Lined With Safety Cuff**

Premium grain pigskin leather palm, thinsulate lined, hi-vis orange back with 1.5-inch lime green reflective tape, 2.5-inch rubberized safety cuff.

SKU	Description	Size	UOM	Price
MSGF8750L	Glove, premium grain pigskin, hi-vis, safety cuff, lined	L	DZ	\$98.84
MSGF8750XL	Glove, premium grain pigskin, hi-vis, safety cuff, lined	XL	DZ	\$108.30



**D. Premium Grain Pigskin Hi-Vis Lined With Knit Wrist**

Premium grain pigskin leather palm, thinsulate lined, hi-vis orange back, 1.5-inch lime green reflective tape, orange knit wrist

SKU	Description	Size	UOM	Price
MSGF8760L	Glove, premium grain pigskin, hi-vis, knit wrist, lined	L	DZ	\$98.84
MSGF8760XL	Glove, premium grain pigskin, hi-vis, knit wrist, lined	XL	DZ	\$100.45



### A. Grain Pigskin Driver's Gloves Lined with Thinsulate®

Thinsulate lined pigskin driver features a keystone thumb and a shirred elastic back.

SKU	Description	Size	UOM	Price
MSG8942	Pigskin driver's gloves lined with Thinsulate	S-XL	DZ	\$95.71

### B. Grain Cow Driver's Gloves Lined with Fleece

This driver's glove keeps your hands warm while allowing outstanding dexterity. Features include white fleece lining, shirred elastic back and keystone thumb.

SKU	Description	Size	UOM	Price
MSG8245	Fleece lined driver's glove	S-XL	DZ	\$92.49

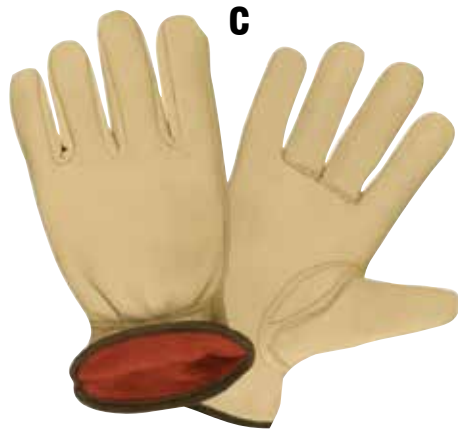

### C. Foam & Red Fleece Lined Driver's Gloves

This full leather driver's glove is made with select leather for abrasion resistance and is foam and red fleece lined for warmth and comfort. Other features include shirred elastic back and keystone thumb.

SKU	Description	Size	UOM	Price
MSG8240	Foam & fleece lined driver's glove	S-XL	DZ	\$100.46

### D. Grain Pigskin Driver's Gloves Lined with Fleece

Visibly more porous leather for greater breath ability. Returns to original softness after becoming wet from application or perspiration. All general purpose applications plus requirements for wet or insulated (cold/hot) conditions.

SKU	Description	Size	UOM	Price
MSG8922	Pigskin driver's gloves lined with fleece	S-XL	DZ	\$82.90





### A. Split Cowhide/Fleece Lined

Split cowhide leather palm, fleece lined, gunn cut pattern, 2.5-inch rubberized safety cuff.

SKU	Description	Size	UOM	Price
MSG7265L	Leather palm, split cowhide, fleece lined	L	DZ	\$43.01



### B. Cold Snap

Cold Snap, premium, green, brushed, loop-in, 7-gauge, acrylic terry shell with black foam latex coating

SKU	Description	Size	UOM	Price
MSG3999	Cold Snap, green acrylic shell, black latex palm	S-XL	DZ	\$40.60



### C. Thermal Liner Gloves

Insulating Liner Glove. Unique glove is manufactured with special fibers to trap warm air near the skin while wicking moisture away. It can be used as a liner or on it's own. Machine washable and shrink-resistant.

SKU	Description	UOM	Price
MSGFBC3730	White Thermostat® Liner	DZ	\$26.58
MSGFBC3830	Blue Thermostat® Liner	DZ	\$31.53
MSGH3677	Black Thermal Liner, Acrylic/Spandex	DZ	\$13.37



### D. Camo Thinsulate lined gloves with LED Lights

This multitasking camo pattern fabric back glove is also constructed with a black synthetic palm with foam lining. It features a PVC grip on palm and fingertips, adjustable wrist closure, 2 HD LED lights and thinsulate lining.

SKU	Description	Size	Color	UOM	Price
MEM924C	Glove Thinsulate lined with LED lights	M-XL	Camo	PR	\$17.89





**A**

### A. Allegro Lightweight Tent Heater

The Lightweight Tent Heater offers the rugged, heavy duty design of all steel housing with enclosed heating elements and a sealed motor. This powerful heater will raise the temperature 50° in a work tent. It is UL listed, CSA approved, requires 110V AC, and offers 1500 watts of 5000BTU with 115 CFM airflow. 12" x 8" x 12", 14 lbs

SKU	Description	UOM	Price
ALLE9401-50	Electric heater 1500 watts 5000 BTU	EA	\$517.54



### B. Tiger Grip® Master-Grip Overshoe

This overshoe will allow you to walk as well on snow and ice as well as on muddy surfaces. Master-grip overshoes have 4 interchangeable studs that you can adapt to your needs.

SKU	Description	Sizes	UOM	Price
TGRMASS	Master-Grip Ice and All-Surface Overshoe	SM 5.5	PR	\$44.28
TGRMASM	Master-Grip Ice and All-Surface Overshoe	MD 6-9.5	PR	\$44.28
TGRMASXL	Master-Grip Ice and All-Surface Overshoe	XL 10-13	PR	\$44.28



**B**



**C**

### C. Trex Adjustable one-piece traction device

Adjustable one-piece traction device for shoes or boots delivers tenacious grip and stability.

Features:

- Rugged steel studs for tenacious grip & stability
- Adjustable cord cinches tight for a secure fit
- Stretchable rubber for fit and easy on/off
- Aggressive tread connects mid-foot and heel stud zones
- Reflective pull-on tab adds enhanced visibility
- Flexible to -40°F (-40°C)

SKU	Description	Size	UOM	Price
ERG6310M	Trex adjustable one-piece traction device for shoes or boots	M	PR	\$22.05
ERG6310L	Trex adjustable one-piece traction device for shoes or boots	L	PR	\$22.05
ERG6310XL	Trex adjustable one-piece traction device for shoes or boots	XL	PR	\$22.05

# HEAT INDEX CHART - PLAN AHEAD & STAY SAFE

## How To Use Heat Index

Locate today's predicted high temperature across the top line (air temp.) Down the left side (relative humidity) locate today's predicted humidity. Follow across and down to find "Apparent Temperature" or "What it feels like." Keep in mind, this chart was devised for shady, light wind conditions, so exposure to full sun can increase values by up to 15°. Strong winds, particularly with hot, dry air can be extremely hazardous.

Source: National Oceanic & Atmospheric Association & OSHA

Air Temp.	70°F 21°C	75°F 24°C	80°F 26°C	85°F 29°C	90°F 32°C	95°F 35°C	100°F 38°C	105°F 41°C	110°F 43°C
Relative Humidity	Apparent Temperature (Degrees Fahrenheit) →								
0%	64°/18°	69°/21°	73°/23°	78°/25°	83°/28°	87°/30°	91°/33°	95°/35°	99°/37°
10%	65°/18°	70°/21°	75°/24°	80°/26°	85°/29°	90°/32°	95°/35°	100°/38°	105°/41°
20%	66°/18°	72°/22°	77°/25°	82°/27°	87°/30°	93°/34°	99°/37°	105°/41°	112°/44°
30%	67°/19°	73°/23°	78°/25°	84°/28°	90°/32°	96°/35°	104°/40°	113°/45°	123°/51°
40%	68°/20°	74°/23°	79°/26°	86°/29°	93°/34°	101°/38°	110°/43°	122°/50°	137°/58°
50%	69°/21°	75°/24°	81°/27°	88°/31°	96°/35°	107°/42°	120°/49°	135°/57°	150°/66°
60%	70°/21°	76°/24°	82°/27°	90°/32°	100°/38°	114°/45°	132°/56°	149°/65°	
70%	70°/21°	77°/25°	85°/29°	93°/34°	106°/41°	124°/51°	144°/62°		
80%	71°/22°	78°/25°	86°/29°	97°/36°	113°/45°	136°/58°	157°/69°		
90%	71°/22°	79°/26°	88°/31°	102°/39°	122°/50°	150°/66°	170°/77°		
100%	72°/22°	80°/26°	91°/33°	103°/42°	133°/56°	166°/74°			



HEAT INDEX	RISK LEVEL	PROTECTIVE MEASURES
Less than 91°F (32°C)	Lower (Caution)	Basic heat safety and planning
91°F to 103°F (32°C to 39°C )	Moderate	Implement precautions and heighten awareness
103°F to 115°F (39°C to 46°C)	High	Additional precautions to protect workers
Greater than 115°F (46°C)	Very High to Extreme	Triggers even more aggressive protective measures

Likelihood of heat disorders with prolonged exposure or strenuous activity:

- Caution
- Extreme Caution
- Danger
- Extreme Danger



### A. 2112® FR 6 oz TrueComfort® 88/12 Coverall

These Lightweight 6 oz. coveralls are made of a 88/12 fabric. They feature a 2-way collar, 2 hidden snaps at front placket, 2 patch chest pockets with flaps one piece sleeve construction, 2-1/2" cuff, snap at cuff. 2 back patch pockets, banded waist and hidden snap at waist. **CAT 2, UL certified as a garment that meets NFPA 70E & NFPA 2112 requirements.**

SKU	Colors	Sizes*									UOM
FRC6NV	Navy	S	M	L	XL	2X	3X	4X	5X	EA	
<b>Price</b>		\$60.81	\$62.99	\$64.77	\$67.09	\$69.41	\$74.14	\$78.26	\$82.53		
FRC6GY	Grey	S	M	L	XL	2X	3X	4X	5X	EA	
<b>Price</b>		\$60.81	\$62.99	\$64.77	\$67.09	\$69.41	\$74.14	\$78.26	\$82.53		
FRC6KH	Khaki	S	M	L	XL	2X	3X	4X	5X	EA	
<b>Price</b>		\$60.81	\$62.99	\$64.77	\$67.09	\$69.41	\$74.14	\$78.26	\$82.53		
FRC6RB	Royal	S	M	L	XL	2X	3X	4X	5X	EA	
<b>Price</b>		\$60.81	\$62.99	\$64.77	\$67.09	\$69.41	\$74.14	\$78.26	\$82.53		

\*Contact customer service for pricing and availability on tall sizes.



**CAT 2**  
NFPA 2112  
NFPA 70E



**CAT 2**  
NFPA 2112  
NFPA 70E



### B. Carhartt® 6 oz FR 88/12 Traditional Twill Coverall

Carhartt's lightweight, 6-ounce, FR twill coverall is made of 88% cotton/12% high-tenacity nylon that wicks away moisture for comfort. It features a spread collar, two chest pockets with flaps, two pass-through pockets, utility pocket, brass front zipper with Nomex® FR zipper tape and inside and outside protective flap, split-back construction, pleated bi-swing back and triple-stitched main seams. Leg opening fits over boots for easy on and off. Carhartt FR and NFPA 2112 / CAT 2 flag label sewn on left-chest pocket. **Meets the performance requirements of NFPA 70E standards and is UL® Classified to NFPA 2112**

SKU	Colors	Sizes*									UOM
CT101244N	Navy	XS	S	M	L	XL	2X	3X	4X	5X	EA
<b>Price</b>		\$86.25	\$86.25	\$86.25	\$86.25	\$86.25	\$86.25	\$102.53	\$102.53	\$102.53	
CT101244K	Khaki	XS	S	M	L	XL	2X	3X	4X	5X	EA
<b>Price</b>		\$86.25	\$86.25	\$86.25	\$86.25	\$86.25	\$86.25	\$102.53	\$102.53	\$102.53	

\*Contact customer service for pricing and availability on short and tall sizes.



### C. TEGGEN® Select 6.25 oz Coverall

TEGGEN® Select protects you from radiant heat, electric arc fires and flash fires, just like bulkier clothing. Only it isn't bulky. In fact, it's downright comfortable - and stays that way - even as the heat rises, because the patented fiber actually sucks moisture from your skin, where it quickly evaporates keeping you cool. Hey, firefighters wear this kind of stuff. Why shouldn't you? Lightweight 6.25 oz, inherently FR - will never wash or wear away. High air permeability means greater comfort with inherent moisture transport. Available in tan and navy blue. Specify size S - 7X. **CAT 2, NFPA 70E and NFPA 2112 compliant.**

SKU	Colors	Sizes											UOM
TGN021208	Tan	S	M	L	XL	2X	3X	4X	5X	6X	7X	EA	
<b>Price</b>		\$131.00	\$131.00	\$131.00	\$131.00	\$157.20	\$157.20	\$157.20	\$157.20	\$176.85	\$176.85		
TGN021608	Navy	S	M	L	XL	2X	3X	4X	5X	6X	7X	EA	
<b>Price</b>		\$131.00	\$131.00	\$131.00	\$131.00	\$157.20	\$157.20	\$157.20	\$157.20	\$176.85	\$176.85		



**CAT 2**  
NFPA 2112  
NFPA 70E





### A. 2112® FR 6 oz TrueComfort® 88/12 Shirt

Built to withstand the toughest environments, the 2112 line of Flash Fire & Arc Flash Protective Clothing from Medsafe offers comprehensive protection in some of the world's most dangerous work environments. These lightweight 6 oz. shirts are made of FR TrueComfort® 88/12 fabric. **All of our garments are UL certified and constructed with flame resistant fabric that is made in the USA. Our line of clothing is both 2112 and 70E certified.**

SKU	Colors	Sizes									UOM
\$45.80	Navy	M	L	XL	2X	3X	4X	5X	6X	EA	
<b>Price</b>		\$41.42	\$42.21	\$44.47	\$45.80	\$48.53	\$51.43	\$53.12	\$61.03		
FRS6KH	Khaki	M	L	XL	2X	3X	4X	5X	6X	EA	
<b>Price</b>		\$41.42	\$42.21	\$44.47	\$45.80	\$48.53	\$51.43	\$53.12	\$56.55		
FRS6GY	Grey	M	L	XL	2X	3X	4X	5X	6X	EA	
<b>Price</b>		\$41.42	\$42.21	\$44.47	\$45.80	\$48.53	\$51.43	\$53.12	\$56.55		
FRS6RB	Royal	M	L	XL	2X	3X	4X	5X	6X	EA	
<b>Price</b>		\$41.42	\$42.21	\$44.47	\$45.80	\$48.53	\$51.43	\$53.12	\$56.55		

A



CAT 2

NFPA 2112  
NFPA 70E



### B. Carhartt® 6 oz FR Work-Dry 88/12 Lightweight Twill Shirt

Carhartt's flame-resistant Work-Dry® lightweight twill shirt is a comfortable choice on warmer days. Constructed of lightweight, 6-ounce FR twill in a blend of 88% cotton and 12% high-tenacity nylon, its Work-Dry® material wicks away moisture for comfort and features an anti-odor fabric treatment. Two chest pockets with flaps and button closures add utility, and two-button adjustable cuffs enhance fit. **CAT 2, NFPA 70E and NFPA 2112 compliant.**

SKU	Colors	Sizes									UOM
CTS003NV	Navy	S	M	L	XL	2X	3X	4X	EA		
<b>Price</b>		\$62.65	\$62.65	\$62.65	\$62.65	\$62.65	\$69.16	\$69.16			
CTS003KH	Khaki	S	M	L	XL	2X	3X	4X	EA		
<b>Price</b>		\$62.65	\$62.65	\$62.65	\$62.65	\$62.65	\$69.16	\$69.16			
CTS003MBL	Med Blue	S	M	L	XL	2X	3X	4X	EA		
<b>Price</b>		\$62.65	\$62.65	\$62.65	\$62.65	\$62.65	\$69.16	\$69.16			
CTS003RB	Royal	S	M	L	XL	2X	3X	4X	EA		
<b>Price</b>		\$62.65	\$62.65	\$62.65	\$62.65	\$62.65	\$69.16	\$69.16			
CTS003GRY	Grey	S	M	L	XL	2X	3X	4X	EA		
<b>Price</b>		\$62.65	\$62.65	\$62.65	\$62.65	\$62.65	\$69.16	\$69.16			

\*Contact customer service for pricing and availability on tall sizes.

B



CAT 2

NFPA 2112  
NFPA 70E



### c. TEGGEN Select® 5.5 oz Long Sleeve Shirts

TEGGEN SELECT® protects you from radiant heat, electric arc fires and flash fires, just like bulkier clothing. Only it isn't bulky. In fact, it's downright comfortable - and stays that way - even as the heat rises, because the patented fiber actually sucks moisture from your skin, where it quickly evaporates keeping you cool. Hey, firefighters wear this kind of stuff. Why shouldn't you? Lightweight 5.5 oz, inherently FR - will never wash or wear away. High air permeability means greater comfort with inherent moisture transport. **CAT 2, NFPA 70E and NFPA 2112 compliant.**

SKU	Colors	Sizes										UOM
TGN011202	Tan	S	M	L	XL	2X	3X	4X	5X	6X	7X	EA
<b>Price</b>		\$70.04	\$70.04	\$70.04	\$70.04	\$84.04	\$84.04	\$84.04	\$84.04	\$94.55	\$94.55	
TGN011602	Navy	S	M	L	XL	2X	3X	4X	5X	6X	7X	EA
<b>Price</b>		\$70.04	\$70.04	\$70.04	\$70.04	\$84.04	\$84.04	\$84.04	\$84.04	\$94.55	\$94.55	

C



CAT 2

NFPA 2112  
NFPA 70E

# Seasonal PPE

## Heat Stress



by Honeywell

### A. Sunbrero

Sunbrero extends brim of a hard cap for shade. The one piece construction requires no assembly and the gray tint blocks 99% of UV rays. Easy to install and remove. Fits Fibre-Metal caps and hats.

SKU	Description	UOM	Price
FIBFMP-SB-1	Sunbrero hat model	EA	\$12.19
FIBFMP-SB-2	Sunbrero cap model	EA	\$11.75

### B. Sun Shields

Sun Shields attach to your existing hard hat and extend the brim all the way around to help protect wearer's ears and neck from the sun's rays. Made of polyurethane.

SKU	Description	UOM	Price
PAUA-S4-M	Sun Shield for V-Gard & Fibre-Metal full brim hats	EA	\$14.26
PAUA-S4-MT	Sun Shield for Topguard hard hats	EA	\$14.26
PAUA-S5-F	Sun Shield for Fibre-Metal caps	EA	\$14.26
PAUA-S5-M	Sun Shield for V-Gard caps	EA	\$14.26



### C. Radians SunShade Hard Hat Accessory

Lightweight cooling device. Protects neck by shading from harmful UV rays. FR: "Non-durable FR protection" is achieved by chemically treating a material that is not naturally flame-resistant, but becomes self-extinguishing after the treatment. Contrasting Trim Detail. NFPA 701 (2004) FR Treated 100% polyester mesh. Fits both cap style and full brim hard hats.

SKU	Description	UOM	Price
RADNSG	Hi-Viz yellow-green SunShade w/ reflective stripe (helmet not included)	EA	\$6.00
RADNSO	Hi-Viz orange SunShade w/ reflective stripe (helmet not included)	EA	\$6.00

### D. Hard Hat Shade

Fits almost every hard hat. Blocks sun and most UV rays. Shade at back of neck facilitates perspiration evaporation. Helps keep workers comfortable.

SKU	Description	UOM	Price
OCCU898-008	White hard hat shade	EA	\$7.00
OCCU898-028	Royal blue hard hat shade	EA	\$7.00



### E. Chill-Its® 6717 Hard Hat Pad and Neck Shade

This hard hat pad and neck shade provides cool comfort 24 to 48 hours when activated in cold water. Ideal for all warm work, Chill-Its body technologies help workers stay cool, fight fatigue, and increase productivity.

SKU	Description	Color	Size	UOM	Price
ERG6717	Hard hat pad with neck shade	Solid blue	One size	EA	\$4.06





**A. Chill-Its® 6670CT Evaporative Hard Hat Neck Shade**

Keeps the sun off while delivering cool comfort to your neck. Advanced PVA material activates easily and quickly when run under water for one minute. Super-evaporative cooling process helps keep you cool. Hook and Loop straps for easy attachment. Re-usable, just re-wet.

SKU	Description	UOM	Price
ERG6670CT	Evaporative hard hat neck shade, lime	EA	\$13.99

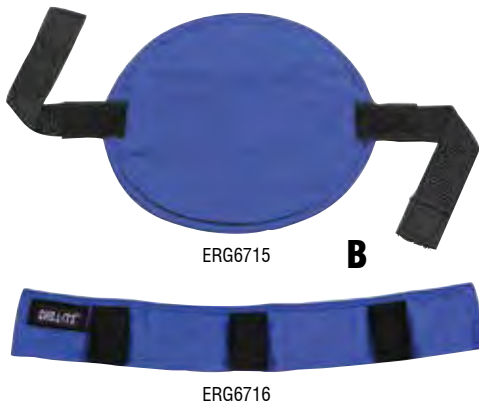
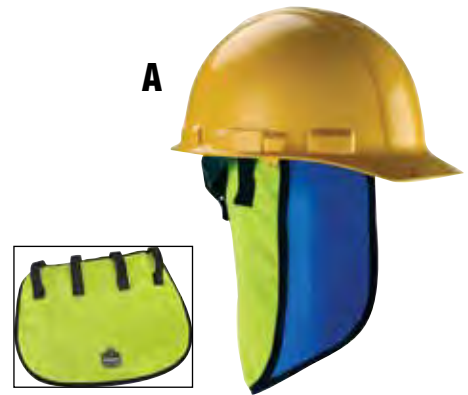

**B. Chill-Its® 6715 Hard Hat Pad/6716 Hard Hat Liner**

These hard hat inserts provide cool comfort 24 to 48 hours when activated in cold water. Ideal for all warm work, Chill-Its body technologies help workers stay cool, fight fatigue and increase productivity.

SKU	Description	Size	Color	UOM	Price
ERG6715	Cooling hard hat pad	Solid blue	One size	EA	\$2.44
ERG6716	Cooling hard hat liner	Solid blue	One size	EA	\$3.01

**C. Chill-Its® 6602 Evaporative Cooling Towel**

Advanced PVA material holds water without feeling heavy. Super-evaporative, feels significantly cooler than ambient air. Wear for hours, or wipe off for quick relief. Simply re-wet the towel to reactivate. Machine washable

SKU	Description	UOM	Price
ERG6602	Evaporative cooling towel, blue	EA	\$8.05

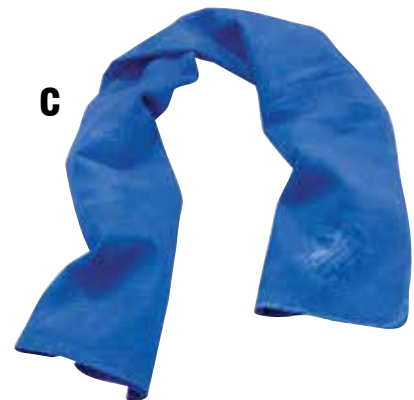

**D. Chill-Its® 6710CT Cooling Triangle Hat With Cooling Towel**

Advanced PVA material activates easily and quickly when run under water for one minute. Re-usable: just soak in water to re-activate, super-evaporative cooling process helps keep you cool. Lightweight and low profile; perfect for under hard hats.

SKU	Description	UOM	Price
ERG6710CT	Triangle hat with cooling towel, lime	EA	\$7.97

**E. Chill-Its® 6710FR Evaporative FR Cooling Triangle Hat**

Soak in water 2-5 minutes to activate. Remains hydrated for up to 4 hours. Modacrylic cotton blend fabric meets ASTM F1506 performance requirements (ATPV rating of 7.1 cal/cm2); classified CAT1 per NFPA 70E. Meets ASTM F2302 for flame resistance.

SKU	Description	UOM	Price
ERG6710FRB	Triangle hat, evaporative cooling, FR, blue	EA	\$11.39







### A. Chill-Its® 6700FR Evaporative FR Cooling Bandana

Soak in water 2-5 minutes to activate. Remains hydrated for up to 4 hours. Modacrylic cotton blend fabric meets ASTM F1506 performance requirements (ATPV rating of 7.1 cal/cm<sup>2</sup>); classified CAT1 per NFPA 70E. Meets ASTM F2302 for flame resistance.

SKU	Description	UOM	Price
ERG6700FRB	Bandanna, FR, evaporative cooling, blue	EA	\$4.88
MSS940-01	Bandanna, evaporative cooling, blue	EA	\$1.79

### B. Chill-Its® 6700CT Cooling Bandana With Cooling Towel

Advanced PVA material activates easily and quickly when run under water for one minute. Re-usable: just soak in water to re-activate, super-evaporative cooling process helps keep you cool. Lightweight and low profile; perfect for under hard hats.

SKU	Description	UOM	Price
ERG6700CTL	Bandana with cooling towel, blue	EAW	\$3.90



### C. HexArmor ColdRush® Bandana

Beat the heat with ColdRush® cooling bandanas. Designed to keep you comfortable and cool all day long. Features eVapora™ cooling technology wicks away sweat and cotton shell. Unisex design, one size fits most. Machine wash, air dry.

SKU	Description	UOM	Price
HEX30200	ColdRush® Bandana, blue	EA	\$10.43

### D. HexArmor ColdRush® Hard Hat Insert

Keep your workers cool and comfortable all day long with ColdRush® hard hat inserts. Features eVapora™ cooling technology wicks away sweat, mesh panels for targeted breathability and Velcro® straps secure ColdRush® inside your hard hat. Machine wash, air dry.

SKU	Description	UOM	Price
HEX30151	ColdRush® Hard Hat Insert, blue	EA	\$14.30



OCCSBR100

MSSTERRIMED

### E. Sweatbands

The blue sweatband is ultra thin yet absorbent. Won't tear, break or flake or become dry and brittle. Contains no chemicals. Made of viscose cellulose. Never requires hydration to soften. Affixes with rubber band. Disposable.

The Terricloth comfort band for industrial headgear is washable, 100% cotton terry material. Colors may vary. It provides extra comfort and unsurpassed absorption of oils and perspiration.

SKU	Description	UOM	Price
OCCSBR100	Blue sweatband	100/PK	\$40.35
MSSTERRIMED	Terricloth sweatband for all hardhats	EA	\$1.77



### A. Chrome Oasis™ 4030

In a heated situation, comfort should be the last thing on your mind. HexArmor® wants to keep it that way. HexArmor added HexVent™ to their most popular mechanic's glove, to provide you with the highest level of cut and impact protection on the market while making sure you aren't overheating due to your PPE. This advanced breathable technology supports our Hi-Vis impact-resistance system, and a layer of Cut 5 SuperFabric® brand material gives you both superior safety and peace of mind. The combination of HexVent™, HexArmor's standard pre-curve design, and double-stitched seams provides added dexterity and durability. Now you can focus on your work, and we'll focus on your comfort and safety.

SKU	Description	Size	UOM	Price
HEX4030	Chrome Oasis glove	S-XL	PR	\$37.75
HEX40302X	Chrome Oasis glove	2X-3X	PR	\$42.91



■ HexArmor Protection Zone - ISEA CUT:5 CE 4521  
■ Impact Protection



### B. Chrome Core Oasis™ 4035

Comfort shouldn't be a luxury, and we at HexArmor® know that safety certainly isn't. That's the reasoning behind our Chrome Core Oasis™ 4035 – a sleek, hi-vis mechanic's glove with a SuperFabric® brand material palm and a HexVent® back of hand. Built to beat the heat, the Chrome Core Oasis™ 4035 also beats laceration hazards with the most advanced technology on the market. With features such as our pre-curved design and double-stitched side seams, you won't have to give up dexterity for the highest level of safety. Our patented SlipFit® cuff also means an easy on and off between jobs.

SKU	Description	Size	UOM	Price
HEX4035	Chrome Core Oasis glove	S-XL	PR	\$35.97
HEX40352X	Chrome Core Oasis glove	2X	PR	\$38.18



■ HexArmor Protection Zone - ISEA CUT:3 CE 4343  
■ Impact Protection

### C. Rig Lizard Oasis™ 2022

In the most extreme work environments, the heat can be nearly unbearable. Outdated leather protective gloves often make this situation worse. Fortunately, HexArmor® listened, and is proud to offer the Rig Lizard Oasis™ 2022. They have created a unique ventilation technology, called HexVent™; an advanced nylon mesh that supports our IR-X™ Impact Exoskeleton™, so you have the distinct advantage of a lightweight, breathable glove without sacrificing any of our industry-leading smash protection. Combining this innovation with our proprietary TP-X™ synthetic high-grip palm yields the level of safety and dexterity you require. ISEA Level 3 cut and puncture protection.

SKU	Description	Size	UOM	Price
HEX2022	Rig Lizard Oasis glove	S-XL	PR	\$32.92
HEX20222X	Rig Lizard Oasis glove	2X	PR	\$36.17



### D. Rig Lizard Thin Lizzie™ 2090

The secondary line of palm-coated gloves from HexArmor®, the 2000 Series™ is purpose-built for an impressive range of applications. Each product in this series is constructed of fiber blend and unique palm coatings. Glove structures are durable, flexible, and cut resistant, offering both dexterity and safety. Varying palm dips increase abrasion resistance, extend product life, and provide the highest grip for many specific uses. The shell is comprised of a 13-gauge high-performance polyethylene and glass fiber blend. Superior back-of-hand impact protection system utilizes an advanced design to dissipate forceful blows over a large area. Sandy Nitrile palm dip increases abrasion resistance and provides exceptional grip in heavy oil and wet situations. Machine washable.

SKU	Description	Size	UOM	Price
HEX2090	Rig Lizard Thin Lizzie glove	S-XL	PR	\$26.48



# Seasonal PPE

## Cooling Vests



### A. Low Profile Hydration Pack

Closed cell insulation keeps water cool for hours while the insulated bite valve cover prevents contamination. Features padded, adjustable shoulder and chest straps. The hydration pack is made of 420 denier nylon.

SKU	Description	UOM	Price
ERGGB5155	Low profile hydration pack, black	EA	\$50.12
ERGGB5155LIM	Low profile hydration pack, lime	EA	\$55.74

### B. Evaporative Cooling Vest

Soak in cold water, and enjoy cooling relief and comfort. Features a V-neck with zipper closure, a quilted nylon outer layer and an activated, polymer-embedded fabric inside. This vest has a water-repellent liner and black cotton-poly elastic trim. It is lightweight, durable, and washable. 100% nylon. Available in lime and gray.

SKU	Description	Size	UOM	Price
ERG6665LIM	Evaporative cooling vest, lime	M-3X	EA	\$36.70
ERG6665GRY	Evaporative cooling vest, gray	M-3X	EA	\$36.70



### C. Chill-Its® 6200 Phase Change Cooling Vest II

For extreme heat conditions there's nothing better to maintain lower body temperatures. Helps manage heat stress by keeping workers safe, cool, comfortable and productive. Model 6200 is sized for medium to large-sized adults. Size: Lrg/XL

SKU	Description	UOM	Price
ERG6200LG/XL	Chill-It cooling vest	EA	\$248.60



### D. Cool Vest

The Cool Vest holds eight ice packs to keep workers cool on the job. Simply freeze the ice packs then place them in the sewn in pouches for one hour of heat relief. Requires 8 ice packs per use.

SKU	Description	UOM	Price
GUA1ORFSCV4P	Cool Vest	EA	\$31.93
343380204	Ice pack, 4.5" X 7"	EA	\$1.80







### A. Yukon™ Cold Lockers

Durability beyond the realm of conventional coolers - Rugged and ice cold, Yukon™ Cold Lockers deliver serious performance for the serious outdoorsman in the most extreme outdoor environments. Yukon™ outhauls, outhills and outlasts anyone.

SKU	Description	UOM	Price
IGL44789	Yukon Cold Locker, 50 quart, purple and gold	EA	\$372.53
IGL44666	Yukon Cold Locker, 50 quart, white	EA	\$337.42
IGL44667	Yukon Cold Locker, 70 quart, white	EA	\$399.40
IGL44668	Yukon Cold Locker, 150 quart, white	EA	\$590.75
IGL44719	Yukon Cold Locker, 250 quart, white	EA	\$904.44



A



B

### B. 400 Series Water Coolers

Delivers cold, clean water. Rugged durable Igloo® 400 Industrial Water Coolers keep water cold, clean and available. Built for the Real World™, the 400 series takes the abuse of the roughest job site and the most punishing work crews. Red and yellow high visibility safety colors. HDPE hide won't chip, peel, buckle or rust. Ultraviolet stabilizers prevent fading and cracking in all exposures. White FDA Grade inner liner is easy to clean and resists stains and odors. Reinforced handles and dispenser bracket. All parts are replaceable for extended life. Specialty colors and labels available upon request.

SKU	Description	UOM	Price
IGL421	2 gal. Water Cooler	EA	\$33.09
IGL431	3 gal. Water Cooler	EA	\$43.21
IGL451	5 gal. Water Cooler	EA	\$50.68
IGL4101	10 gal. Water Cooler	EA	\$78.07

### C. Plastic Cup Dispenser

Add a convenient cup dispenser to your Igloo beverage cooler! Model Number IGL1148 holds 4 - 4.25 ounce cone cups and model number IGL9534 holds 7 - 8 ounce cone cups. Fits 3, 5 and 10-Gallon Igloo beverage coolers that are equipped with a cup dispenser bracket.

SKU	Description	UOM	Price
IGL1148	Plastic cup dispenser	4 - 4 1/2 oz	\$18.77
IGL9534	Plastic cup dispenser	7 - 8 oz	\$24.51

C

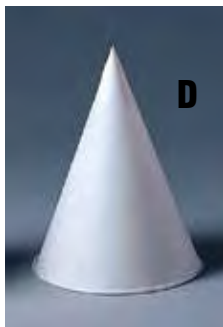

D

### D. Cups

Sturdy cups, either straight rim or rolled rim. Paper cups are 4 1/2 oz or 7 oz with rolled rim. 20 x 250's. Dispenser attaches to cooler.

SKU	Description	UOM	Price
KON45KSE	4 1/2 oz cups	CS	\$88.53
SOLO156	7 oz ST rim	CS	\$194.68

### E. Water Cooler Sealing Tape

The label warns against dipping contents from the cooler, and provides spaces for documenting contents (if other than potable water), date prepared, time prepared, preparer's initials, and owner's name.

SKU	Description	UOM	Price
SGCTAPE	Water cooler sealing tape	EA	\$7.71

E

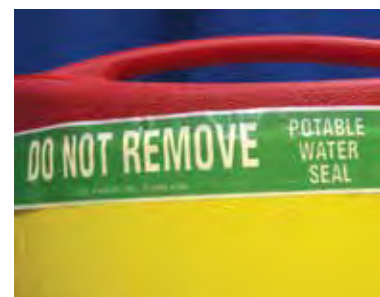



**A**

### A. Powder Pack™ Mixes

Great tasting, scientifically formulated electrolyte replacement drink is designed to restore important mineral salts and fluids lost through dehydration, physical exertion and heat stress. Sqwincher is more satisfying than water or soft drinks because the body absorbs it more quickly and restores it to its proper electrolyte and fluid balance. Powder Pack mixes quickly and easily with water. Sqwincher is the natural recovery source for dehydration. Powder Pack concentrate mixes are available in 1, 2 1/2, or a 5 gallon packet.

SKU	Description	Yields	Flavor	UOM	Price
SQW16005	Powder pack	1 gallon	Fruit punch	80/CS	\$127.18
SQW16006	Powder pack	1 gallon	Grape	80/CS	\$127.18
SQW16008	Powder pack	1 gallon	Lemon lime	80/CS	\$127.18
SQW16040	Powder pack	2 1/2 gallon	Lemonade	32/CS	\$121.81
SQW16041	Powder pack	2 1/2 gallon	Orange	32/CS	\$121.81
SQW16042	Powder pack	2 1/2 gallon	Fruit Punch	32/CS	\$121.81
SQW16043	Powder pack	2 1/2 gallon	Lemon Lime	32/CS	\$121.81
SQW16045	Powder pack	2 1/2 gallon	Tea	32/CS	\$121.81
SQW16047	Powder pack	2 1/2 gallon	Cherry	32/CS	\$121.81
SQW16049	Powder pack	2 1/2 gallon	Tropical cooler	32/CS	\$121.81
SQW16046	Powder pack	2 1/2 gallon	Grape	32/CS	\$121.81
SQW016800	Powder pack Lite	2 1/2 gallon	Lemon lime	24/CS	\$110.67
SQW016801	Powder pack Lite	2 1/2 gallon	Orange	24/CS	\$110.67
SQW016803	Powder pack Lite	2 1/2 gallon	Fruit Punch	24/CS	\$110.67
SQW016804	Powder pack Lite	2 1/2 gallon	Grape	24/CS	\$110.67
SQW16400	Powder pack	5 gallon	Mixed berry	16/CS	\$112.37
SQW16401	Powder pack	5 gallon	Cherry	16/CS	\$112.37
SQW16402	Powder pack	5 gallon	Cool citrus	16/CS	\$112.37
SQW16403	Powder pack	5 gallon	Lemonade	16/CS	\$112.37
SQW16404	Powder pack	5 gallon	Orange	16/CS	\$112.37
SQW16405	Powder pack	5 gallon	Fruit Punch	16/CS	\$112.37
SQW16406	Powder pack	5 gallon	Grape	16/CS	\$112.37
SQW16408	Powder pack	5 gallon	Lemon Lime	16/CS	\$112.37
SQW16409	Powder pack	5 gallon	Tropical cooler	16/CS	\$112.37

### B. Fast Pack® Liquid Concentrate

Just add water to pack and you've got a single serving of fluids and electrolytes. Packet can be used as a drinking cup. Reduce heat stress and dehydration with these convenient drink packs. Their handy size makes them less bulky than transporting a cooler, but big enough to quench your thirst.

SKU	Description	Size	Yields	Flavor	UOM	Price
SQW15300	Fast Pack	.6 oz	6 oz	Mixed berry	200/BX	\$61.19
SQW15310	Fast Pack	.6 oz	6 oz	Cool Citrus	200/BX	\$61.19
SQW15301	Fast Pack	.6 oz	6 oz	Cherry	200/BX	\$61.19
SQW15302	Fast Pack	.6 oz	6 oz	Grape	200/BX	\$61.19
SQW15303	Fast Pack	.6 oz	6 oz	Lemonade	200/BX	\$61.19
SQW15304	Fast Pack	.6 oz	6 oz	Orange	200/BX	\$61.19
SQW15305	Fast Pack	.6 oz	6 oz	Fruit Punch	200/BX	\$61.19
SQW15308	Fast Pack	.6 oz	6 oz	Lemon lime	200/BX	\$61.19
SQW15309	Fast Pack	.6 oz	6 oz	Tropical cooler	200/BX	\$61.19
SQW015500OR	Fast Pack Lite	.6 oz	.6 oz	Orange	200/BX	\$61.19
SQW015501FP	Fast Pack Lite	.6 oz	.6 oz	Fruit Punch	200/BX	\$61.19

**B**



**C**



### C. Sqwincher Qwik Stik

Enjoy the same great taste you expect from Sqwincher available without any carbs or calories in a convenient single-serve pouch. Mixing Sqwincher "Lite" has never been easier. Just tear open the handy pouch, add to your favorite 20 oz. bottled water, shake the bottle gently and enjoy all the benefits of Sqwincher "Lite."

SKU	Description	Flavor	UOM	Price
SQW060099	Sqwincher Qwik Stik	Strawberry Lemonade	500/CS	\$186.34
SQW060100	Sqwincher Qwik Stik	Orange	500/CS	\$186.34
SQW060101	Sqwincher Qwik Stik	Mixed Berry	500/CS	\$186.34
SQW060102	Sqwincher Qwik Stik	Fruit Punch	500/CS	\$186.34
SQW060103	Sqwincher Qwik Stik	Lemonade	500/CS	\$186.34
SQW060104	Sqwincher Qwik Stik	Peach Tea	500/CS	\$186.34
SQW060105	Sqwincher Qwik Stik	Raspberry	500/CS	\$186.34
SQW060109	Sqwincher Qwik Stik	Cool Citrus	500/CS	\$186.34



### A. Liquid Concentrate Activity Drink

When large quantities of Sqwincher are needed to cover your work crew or if you need to place Sqwincher near a cold water drinking fountain, choose Sqwincher 64 oz. Bottles. The same great taste and product composition available in a liquid concentrate. Each 64 oz. bottle yields 5 gallons of finished product which mixes instantly with water when added; no stirring required. Chosen time and time again in industrial taste tests, Sqwincher is the natural recovery source for dehydration and has proven to be "The Drink of Industry". Available in a variety of flavors which are sure to satisfy everyone's tastes, put Sqwincher to work for your crew today. Available in 32 oz Bottles.

SKU	Description	Size	Yields	Flavor	UOM	Price
SQW20222	Liquid concentrate	32 oz	2 1/2 gallon	Grape	12/CS	\$61.60
SQW20224	Liquid concentrate	32 oz	2 1/2 gallon	Lemon lime	12/CS	\$61.60
SQW20225	Liquid concentrate	32 oz	2 1/2 gallon	Fruit punch	12/CS	\$61.60
SQW20226	Liquid concentrate	32 oz	2 1/2 gallon	Orange	12/CS	\$61.60
SQW30321	Liquid concentrate	64 oz	5 gallon	Cherry	6/CS	\$56.96
SQW30322	Liquid concentrate	64 oz	5 gallon	Grape	6/CS	\$56.96
SQW30323	Liquid concentrate	64 oz	5 gallon	Lemonade	6/CS	\$56.96
SQW30324	Liquid concentrate	64 oz	5 gallon	Orange	6/CS	\$56.96
SQW30325	Liquid concentrate	64 oz	5 gallon	Fruit punch	6/CS	\$56.96
SQW30328	Liquid concentrate	64 oz	5 gallon	Lemon-lime	6/CS	\$56.96
SQW30329	Liquid concentrate	64 oz	5 gallon	Tropical cooler	6/CS	\$56.96
SQW50102	Liquid concentrate Lite	64 oz	5 gallon	Fruit punch	6/CS	\$56.96
SQW50103	Liquid concentrate Lite	64 oz	5 gallon	Grape	6/CS	\$56.96
SQW50107	Liquid concentrate Lite	64 oz	5 gallon	Orange	6/CS	\$56.96



### B. Sqwincher Wide-Mouth Ready-to-Drink

Sqwincher 20oz. WideMouth is available in our 6 of our popular flavors, Grape, Orange, Fruit Punch, and Lemon-Lime. WideMouth bottles feature an extra-wide opening for easy product consumption and enjoyment.

SKU	Description	Flavor	UOM	Price
SQW030530	Sqwincher RTD 20 oz wide mouth	Mixed Berry	24/CS	\$31.57
SQW030531	Sqwincher RTD 20 oz wide mouth	Cool citrus	24/CS	\$31.57
SQW030532	Sqwincher RTD 20 oz wide mouth	Grape	24/CS	\$31.57
SQW030534	Sqwincher RTD 20 oz wide mouth	Orange	24/CS	\$31.57
SQW030535	Sqwincher RTD 20 oz wide mouth	Fruit punch	24/CS	\$31.57
SQW030538	Sqwincher RTD 20 oz wide mouth	Lemon-lime	24/CS	\$31.57

### C. 12 oz. Aluminum Can RTD

Whether you're putting in 12 hour shifts at the foundry, shooting hoops down at the playground or sweating it out in the backyard, you're going to get thirsty. Sqwincher's great-tasting electrolyte replacement formula not only quenches thirst, but re-hydrates, restores and recharges the body to keep you at peak performance.

SKU	Description	Flavor	UOM	Price
SQW100104OR	Sqwincher 12 oz RTD can	Orange	24/CS	\$18.39
SQW100105FP	Sqwincher 12 oz RTD can	Fruit Punch	24/CS	\$18.39
SQW100108LL	Sqwincher 12 oz RTD can	Lemon-Lime	24/CS	\$18.39







**A**

### A. Squincher Beverage Enhancer

Introducing Squincher Beverage Enhancer - Hydrate and Recharge the body with the perfect sugar free ELECTROLYTE BEVERAGE concentrate! NO SUGAR, NO CALORIES...no worries! Each bottle yields 24 eight ounce servings.

SKU	Description	Flavor	UOM	Price
SQW10700-FP	Beverage Enhancer 8oz	Fruit Punch	EA	\$4.98
SQW10701-SL	Beverage Enhancer 8oz	Strawberry Lemonade	EA	\$4.98

### B. Squincher Sqweeze

More than a freezer pop. Squincher Sqweeze is isotonic sports ice. Frozen electrolytes to cool the body down quickly.

SKU	Description	UOM	Price
SQW159200201	Squincher Sqweeze assorted flavors 150/CS	CS	\$42.31



**B**



**C**

### C. Squincher Sqweeze ZERO

Now you can get your favorite electrolyte freeze pops in a No Sugar, No Calorie treat. Still has the same cooling power and electrolyte replenishment you have grown to love.

SKU	Description	Flavor	UOM	Price
SQW159200228	Squincher Sqweeze ZERO 150/CS	Fruit Punch	CS	\$42.31
SQW159200229	Squincher Sqweeze ZERO 150/CS	Orange	CS	\$42.31

### D. Squincher Energy Bursts Chews

Introducing Squincher Energy Bursts – Electrolyte Energy Chews for a great tasting boost of energy in three awesome flavors: Orange, Wild Berry and Black Cherry.

SKU	Description	Flavor	UOM	Price
SQW10370-OR	Energy Bursts Chews 1oz 96/CS	Orange	CS	\$203.35
SQW10371-WB	Energy Bursts Chews 1oz 96/CS	Wild Berry	CS	\$203.35
SQW10372-BC	Energy Bursts Chews 1oz 96/CS	Black Cherry	CS	\$203.35
SQW10374-PL	Energy Bursts Chews 1oz 96/CS	Pink Lemonade	CS	\$203.36



**D**



**E**

### E. Heat Stress Label

Adhesive vinyl label that measures 7" x 9" and clearly indicates the symptoms and treatments for various heat related illnesses. This label is blue and white.

SKU	Description	UOM	Price
MSS23275	Heat stress label	EA	\$1.79



### A. Ergodyne® 6000 SHAX™ Utility Tent

The Ergodyne® SHAX™ Utility Tents are versatile and durable instant shelters that provide fast, long lasting relief from the sun, wind and rain. This 10'x10', with a peak height of 11' tent has a 300D polyester top with PU and UV coatings that give your crew full protection from the elements. It is supported by a powder coated Tenacious steel frame construction with rust resistant powder coating that will stand up over the long haul. Other features include ABS plastic sliders for convenient height adjustment, double vented top, reflective accent stripes mean enhanced visibility and increased protection and reinforced polyester corners deliver additional strength and durability for everyday use. Includes wheeled bag for easy storage and transport, heavy-duty ground stakes and ropes. 46 lbs – easy assembly allows for quick set-up and take down.

SKU	Description	UOM	Price
ERG6000	Tent pop-up utility 10' x 10', Peak 11'	EA	\$325.41



### B. Ergodyne® SHAX™ Lightweight Tent

10' x 10' (3m x 3m) foot-print, peak height of 14' (3.35m). 210D Polyester top with PU coating. Hammer tone steel frame. Pull pin sliders for convenient height adjustment between 10' - 14' (3.05m - 4.27m). Features reinforced corners and wheeled storage bag. Meets CPAI-84 flame resistance code

SKU	Description	UOM	Price
ERG6010	Tent Lightweight 10' x 10', Peak 10'-14'	EA	\$210.44

### C. Ergodyne® SHAX™ Lightweight Industrial Umbrella

Size: 84" (2.1m) diameter. 300D Polyester Shell with PU and UV coatings. Meets CPAI-84 flame resistance code. Powder coated tenacious steel pole & ribs. Tilt mechanism for full sun protection. Vented top for maximum airflow. Four different height options with peak height of 92" (2.3m). Includes over-the-shoulder, oversized storage bag with convenient pocket & ground spike

SKU	Description	UOM	Price
ERG6100	Lightweight Industrial Umbrella	EA	\$133.89
ERG6190	Umbrella Stand	EA	\$181.73
ERG6192	Umbrella Replacement Ground Spike	EA	\$19.06



### D. Sunscreen

SunX sunscreen is a fully FDA compliant and tested sunscreen with the most sought after features. First it has an SPF of 30+, which offers you 97% protection from harmful UV rays. SunX sunscreen also vanishes quickly and bonds well to the skin leaving behind no mess. Ingredients include Aloe Vera gel and Vitamin E. Passed lineman's glove testing, Type 1 Class 2 ANSI/ASTM D120.

SKU	Description	UOM	Price
SUNX71430	Sunscreen pouches	25/BX	\$16.33
SUNX71440	Sunscreen towelettes	25/BX	\$20.45
SUNX71661	Sunscreen 2 oz spray	EA	\$3.99
SUNX71662	Sunscreen 2 oz lotion bottle	EA	\$2.65
SUNX71664	Sunscreen 4 oz lotion bottle	EA	\$4.78
SUNX91661	Sunscreen towelette wall dispenser	50/BX	\$42.11
SUNX91663	Sunscreen pouches wall dispenser	50/BX	\$38.45





**A**

### A. Wristbands

A good choice for recreational and lighter-duty applications, the vapors from the BugBand™ wristband form a protective shield several feet around the immediate area, keeping insects a safe distance away. The wristband comes in a resealable pod and can last up to 120 hours. A patented break-away strap on the wristband releases if it becomes entangled. Effective against mosquitoes, flies, gnats, no-see-ums and fleas.

SKU	Description	Color	UOM	Price
BUG88206	BugBand wristband family pak	Assorted	4/PK	\$15.25

**B**



### B. Towelettes

Easy to use, safe and effective, BugBand™ towelettes allow for direct application of Geraniol lotion onto exposed skin. They're ideal for using around your face or neck without over-applying. Effective against mosquitoes, ticks, flies, gnats, no-see-ums and fleas.

SKU	Description	UOM	Price
BUG88506	BugBand towelettes, foil 2-paks	50/PK	\$44.45
BUG88540	BugBand towelettes, 40 count tub	EA	\$14.15

**C**



### C. Spreadable Geraniol For Yard & Garden

Outdoor activities for children and adults need not be a battle with biting insects. Whether you are responsible for a children's playground or having an outdoor event at your home, Bug-Band™ Spreadable Geraniol Insect Repellent is a "must have" item. Easily apply the granular repellent from the shaker bottle or with your own spreader. Repeat the application every two days or after rain to repel such pests as mosquitoes, flies, gnats, no-see-ums and fleas.

SKU	Description	UOM	Price
BUG88991M	4.3 lbs BugBand shaker bottle	EA	\$18.05
BUG88992	160 lbs BugBand fiber drum	EA	\$397.01

**D**



### D. Pump Spray

Perfect for when you need heavy-duty protection, BugBand™ spray lotion does not contain any propellants, but relies on a highly effective metered pump sprayer to dispense a fine mist of Geraniol lotion over the area to be treated. By spraying the BugBand™ liquid directly on clothing or skin, the Geraniol vapors form a protective barrier to deter blood-sucking insects from biting. It is ideal for use around the ankles, wrist or neck where insects tend to invade clothing. Use once for hours of insect protection. Effective against mosquitoes, ticks, flies, gnats, no-see-ums and fleas. Retains FR properties when sprayed on Indura or Nomex.

SKU	Description	UOM	Price
BUG88336	BugBand pump spray bottle, 6 oz	EA	\$8.90

**E**



### E. OFF!® Insect Repellent

Available in our famous orange can, has remained one of the most popular repellents in the United States for over 40 years. Ideal for the entire family and is now available in fresh scent. This medium-strength repellent provides protection from mosquitoes, gnats, deer flies, sand flies, stable flies, black flies, ticks, chiggers and fleas. OFF! Insect Repellent contains 15% DEET and because it resists perspiration, it's a perfect choice for use at family activities like picnics, gardening, walks in the woods, and other activities. Deep Woods OFF! contains 25% DEET.

SKU	Description	UOM	Price
SCJO1813	OFF! 6 oz can	EA	\$7.75
SCJO1842-8	Deep Woods OFF! 6 oz can	EA	\$8.60





### A. Sprayon® Insect Repellent II

Effectively repels mosquitoes, chiggers, ticks, deer flies, stable flies, black flies, gnats and fleas; also protects against Lyme disease. Does not contain R-11, EPA-registered.

SKU	Description	UOM	Price
SPRS00856	Insect repellent II 6 oz Net Wt.	EA	\$6.07

A



B

### B. Sprayon® Blast' Em™ Wasp & Hornet Killer

This F2 rated insecticide contains a high amount of petroleum distillates for the best knock-down and kill rate. Kills wasps, hornets, yellow jackets, flies, mosquitoes and flying moths. Residual deposit will kill returning wasps and hornets (Read label for proper indoor application). Will not harm most plastics, including Noryl, ABS and Lexan. 98% knockdown, 100% kill within 24 hours. Dielectric strength: 33,000 volts Sprays up to 20 feet, EPA-Registered.

SKU	Description	UOM	Price
SPRS00857	Blast' Em Wasp & Hornet Killer 12 oz Net Wt	EA	\$6.87



### C. Bug X Free™ Insect Repellent

With the ongoing threat of insect transmitted diseases like West-Nile Virus, Lime Disease and Malaria there is finally an industrial DEET FREE insect repellent that works.

Bug X FREE has the natural ingredient "Geraniol" (derived from geraniums) and is an all natural insect repellent effective against mosquitoes, ticks, chiggers, fleas, gnats, red bugs, no-see-ums, sand fleas, biting flies, stable flies, and black flies.

SKU	Description	UOM	Price
SUNX12842	Bug X Free natural insect repellent towelettes 100/CS	100/CS	\$67.18
SUNX12844	Bug X Free natural insect repellent towelettes 50/BX	50/BX	\$37.89
SUNX12850	Bug X Free natural insect repellent 2 ounce spray bottle	EA	\$3.27
SUNX12851	Bug X Free natural insect repellent 4 ounce spray bottle	EA	\$6.03
SUNX12856	Bug X Free natural insect repellent 8 ounce spray bottle	EA	\$11.20
SUNX12744	Bug X Free natural insect repellent wrist band	EA	\$5.34

C



D

### D. Bug X 30™ Insect Repellent

BugX30 repels mosquitoes, ticks, fleas, chiggers, black flies, sand flies and deerflies. If bugs are a problem where you work, you need BugX! Towelette allows easy, uniform application, especially to the face area. Contains 30% active DEET. Licensed for sale, according to EPA regulations, in all 50 states. Dispenser of 25.

SKU	Description	UOM	Price
SUNX12642	BugX30 towelette bulk packed	100/BX	\$74.33
SUNX12640	BugX30 towelette clam shell dispenser chip board box	25/BX	\$19.44

### E. Ivy X Pre-Contact Solution

Apply before being exposed to poison ivy, poison oak or sumac. Product goes on easy and dries quickly, almost unnoticeable. No sticky, greasy or clay-like residue. Washes off with soap and water.

SKU	Description	UOM	Price
SUNX83640	Pre-contact towelettes clam shell dispenser chip board box	25/BX	\$16.33
SUNX83666	Pre-contact solution 4 oz	EA	\$3.36
SUNX83661	Pre-contact spray 4 oz	EA	\$3.88

E



# Seasonal PPE

## Itch Relief



**A**

### A. Ivy X Post-Contact Cleanser

Use this product after exposure to poisonous plants to remove their oils. Cleanser has little or no odor, is gentle to the skin and contains moisturizers to keep skin soft.

SKU	Description	UOM	Price
SUNX84640	Post-contact towelettes clam shell dispenser chip board box	25/BX	\$11.83
SUNX84664	Post-contact cleanser 4 oz bottle	EA	\$2.44

### B. Itch Relief Spray

Economical 2 oz. spray. External analgesic that provides temporary relief for insect bites, minor rashes due to poison ivy, oak, & sumac. Maximum strength formula.

SKU	Description	UOM	Price
WJAI2-24	Itch relief spray 2 oz.	EA	\$2.63

**B**



**C**

### C. Benadryl®

For the temporary relief of pain and itching associated with insect bites, sunburn, minor cuts, minor burns, minor skin irritations, scrapes and rashes due to poison ivy, poison oak and poison sumac. Dries the oozing and weeping of poison ivy, poison oak and poison sumac.

SKU	Description	UOM	Price
1254-7171-67	Benadryl Maximum Strength 2% cream 1 oz tube	EA	\$6.32
0071-9501-15	Benadryl Maximum Strength 2% spray 2 oz	EA	\$7.97

### D. Caladryl®

Temporarily relieves itching and pain associated with insect bites, minor skin irritations and rashes due to poison ivy, poison oak or poison sumac. Dries the oozing and weeping of poison ivy, poison oak and poison sumac.

SKU	Description	UOM	Price
0071-3181-19	Caladryl 6 oz lotion bottle	EA	\$7.32
0071-0311-80	Caladryl clear lotion 6 oz bottle	EA	\$7.32

**D**



**E**

### E. Foille®

Foille medicated ointment is an external analgesic for the temporary relief of pain caused by minor burns, sunburn, insect bites, scrapes, cuts and minor skin irritations. Foille spray stops pain on contact and helps heal and prevent infection.

SKU	Description	UOM	Price
4138-3302	Foille ointment 1 oz tube	EA	\$3.82

### F. Bactine

Bactine kills germs as it soothes the pain and itch of minor cuts, scrapes and burns.

SKU	Description	UOM	Price
1650-0020-07	Bactine squeeze bottle 4 oz	EA	\$6.29

**F**



# Lockout/Tagout





# Master Lock



**A**

### A. 410 Xeny Series Padlocks

The 410 Xeny Safety Padlock has a 1-1/2" (3.8cm) wide 1-3/4" (4.4cm) tall Xeny body and 1-1/2" (3.8cm) a shackle clearance. Designed exclusively for Lockout/Tagout applications it has a durable, lightweight, non-conductive Xeny lock body. Customize on-site with permanent, write-on labels. Compliance with OSHA "one employee, one lock, one key" directive. Other features such as high security, reserved-for-safety cylinder, key retaining-ensures that padlock is not left unlocked and keyed different 6-pin tumbler cylinder.

SKU	Description	Color	UOM	Price
MAS410KARED	1 3/4" keyed alike	Red	EA	\$13.46
MAS410KAYEL	1 3/4" keyed alike	Yellow	EA	\$13.46
MAS410KABLK	1 3/4" keyed alike	Black	EA	\$13.46
MAS410KABLU	1 3/4" keyed alike	Blue	EA	\$13.46
MAS410KAGR	1 3/4" keyed alike	Green	EA	\$13.46
MAS410KAORAN	1 3/4" keyed alike	Orange	EA	\$13.46
MAS410KAPURP	1 3/4" keyed alike	Purple	EA	\$13.46
MAS410KATEAL	1 3/4" keyed alike	Teal	EA	\$13.46
MAS410KDRED	1 3/4" keyed different	Red	EA	\$12.61
MAS410KDYEL	1 3/4" keyed different	Yellow	EA	\$12.61
MAS410KDBLK	1 3/4" keyed different	Black	EA	\$12.61
MAS410KDBLU	1 3/4" keyed different	Blue	EA	\$12.61
MAS410KDGRN	1 3/4" keyed different	Green	EA	\$12.61
MAS410KDORG	1 3/4" keyed different	Orange	EA	\$12.61
MAS410KDPRP	1 3/4" keyed different	Purple	EA	\$12.61
MAS410KDTEAL	1 3/4" keyed different	Teal	EA	\$12.61

### B. 411 Xeny Series Padlocks

The 411 Xeny Safety Padlock has a 1-1/2" (3.8cm) wide 3" (4.4cm) tall Xeny body and 1-1/2" (3.8cm) a shackle clearance. Designed exclusively for Lockout/Tagout applications it has a durable, lightweight, non-conductive Xeny lock body. Customize on-site with permanent, write-on labels. Compliance with OSHA "one employee, one lock, one key" directive. Other features such as high security, reserved-for-safety cylinder, key retaining-ensures that padlock is not left unlocked and keyed different 6-pin tumbler cylinder.

SKU	Description	Color	UOM	Price
MAS411KARED	3" tall body, keyed alike	Red	EA	\$14.75
MAS411KAYLW	3" tall body, keyed alike	Yellow	EA	\$14.75
MAS411KABLK	3" tall body, keyed alike	Black	EA	\$14.75
MAS411KABLU	3" tall body, keyed alike	Blue	EA	\$14.75
MAS411KAGR	3" tall body, keyed alike	Green	EA	\$14.75
MAS411KAORJ	3" tall body, keyed alike	Orange	EA	\$14.75
MAS411KAPURP	3" tall body, keyed alike	Purple	EA	\$14.75
MAS411KATEAL	3" tall body, keyed alike	Teal	EA	\$14.75
MAS411KDRED	3" tall body, keyed different	Red	EA	\$13.91
MAS411KDYLW	3" tall body, keyed different	Yellow	EA	\$13.91
MAS411KDBLK	3" tall body, keyed different	Black	EA	\$13.91
MAS411KDBLU	3" tall body, keyed different	Blue	EA	\$13.91
MAS411KDGRN	3" tall body, keyed different	Green	EA	\$13.91
MAS411KDORJ	3" tall body, keyed different	Orange	EA	\$13.91
MAS411KDPUR	3" tall body, keyed different	Purple	EA	\$13.91
MAS411KDTEAL	3" tall body, keyed different	Teal	EA	\$13.91



**B**



**C**

### C. 1100 Series Padlocks

The 1100 series lockout padlock features a solid aluminum body for corrosion resistance that allows for indoor or outdoor usage even in the harsh of environments. Features include lightweight, spark-resistant and laser engraveable. Keyed alike option available on these locks. Available in black = BLK, blue = BLU, yellow = YEL, green = GRN, orange = ORG, purple = PRP and red = RED. Specify color in place of XXX when ordering.

SKU	Description	Shackle Height	UOM	Price
AME1105XXXKD	1105 padlock, keyed different	1"	EA	\$12.18
AME1105XXXKA	1105 padlock, keyed alike	1"	EA	\$13.02
AME1106XXXKD	1106 padlock, keyed different	1 1/2"	EA	\$13.49
AME1106XXXKA	1106 padlock, keyed alike	1 1/2"	EA	\$14.33
AME1107XXXKD	1107 padlock, keyed different	3"	EA	\$14.75
AME1107XXXKA	1107 padlock, keyed alike	3"	EA	\$15.61

# Master Lock



### A. No. 3 Padlocks

Features 1-9/16" wide laminated steel body for superior strength. Hardened steel shackle for extra cut resistance. 4-pin cylinder helps prevent picking. Dual locking levers provide extra pry resistance. Thousands of key changes maximize key integrity. Proprietary rust proofing for longer life.

SKU	Description	Color	UOM	Price
MAS3BLK	Keyed different	Black	EA	\$9.16
MAS3BLU	Keyed different	Blue	EA	\$9.16
MAS3RED	Keyed different	Red	EA	\$9.16
MAS3GRN	Keyed different	Green	EA	\$9.16
MAS3WHT	Keyed different	White	EA	\$9.16
MAS3YEL	Keyed different	Yellow	EA	\$9.16
MAS71TAG	Lockout identification tag w/ring 12/PK	Brass	PK	\$16.82



### B. Safety Lockout Hasps

Heavy gauge steel, resists prying. Each hasp allows for lockout by up to 6 workers. Compatible with Nos. 3, 410, 411, 6835 and 6836 safety lockout padlocks.

SKU	Description	Size	UOM	Price
MAS420	Red lockout hasp	1"	EA	\$5.14
MAS421	Red lockout hasp	1 1/2"	EA	\$6.04

### C. Personal Lockout Kit – Electrical

A 1457 safety carry case containing: 3-No. 410 red Xenoy padlocks, keyed alike, 1-7C5RED circuit breaker padlock, 1-420 lockout hasp, 1-427 snap-on red hasp, 2-491B grip tight lockout for wide or tall breaker toggles, 3-493B grip tight devices for standard size breaker toggles, 1-496B universal wall switch cover toggle and paddle switch and 1 bag of 12-497A danger tags.

SKU	Description	UOM	Price
MAS1457E410A	Personal Lockout Kit – Electrical	EA	\$135.18



### D. Personal Lockout Pouch Kit

A 1456 safety lockout pouch containing: 3-No. 410 red Xenoy padlocks, keyed alike, 1-420 lockout hasp and 1 bag of 12-497A danger tags.

SKU	Description	UOM	Price
MAS1456P410A	Personal Lockout Pouch Kit	EA	\$83.18

### E. Lockout Tags

Tags are self-laminated to protect against weather and tampering. They are metal-reinforced to withstand OSHA's 50 pound of tensile strength requirement. Tags meet OSHA's Lockout/Tagout standard (29CFR1910.47).

SKU	Description	Material	UOM	Price
MSS124	Lockout Tags 25/PK	Vinyl	PK	\$16.48



Back

Front





**A**

### A. Lockout/Tagout Kit

It is imperative that workers properly lockout/tagout machinery and equipment to prevent serious injury. The lockout kit provides all items required to make lockout/tagout as convenient and easy as possible.

Includes: (1) 16" tool box w/tray, (1) V-SAFE lockout 2", (1) B-SAFE lockout, (1) #3D Master locks, (1) #1DLJ Master Lock, (1) M-SAFE nylon hasp, (5) DO NOT OPERATE TAGS / 25, (1) CB04C-SAFE circuit breaker lockout, (1) CB03 C-SAFE circuit breaker lockouts, (1) E-SAFE Lock-A-Switch, (1) E-SAFE lockout 110-220 volts.

SKU	Description	UOM	Price
ARCLK107FE	Lockout/Tagout Kit	EA	\$118.98

### B. Electrical Lockout/Tagout Kit

This kit provides all items to properly secure electrical machinery and equipment from causing serious injury while being serviced. All items can be easily carried in lightweight carrying bag. Includes: (1) Nylon carrying bag, (6) CB03 C-SAFE circuit breaker lockouts, (6) CB01 C-SAFE circuit breaker lockouts, (6) CB04 C-SAFE circuit breaker lockouts, (6) E-SAFE Lock-A-Switch, (1) E-SAFE lockout 110-220 volts, (1) E-SAFE lockout 220-550 volts, (2) M-SAFE nylon hasp, (1) Metal Lockout Hasp, (2) #3D Master Lock, (2) #1DLJ Master Lock, (10) DO NOT OPERATE TAGS / 25.

SKU	Description	UOM	Price
ARCLK108FE	Electrical Lockout/Tagout Kit	EA	\$271.28



**B**

### C. Valve Lockout/Tagout Kit

North has the original B-Safe ball and V-Safe gate valve lockouts. These make lockout/tagout of valves an easy procedure with an easy to transport lockout/tagout kit.

Includes: (1) Nylon carrying bag, (2) V-SAFE lockout 2", (2) V-SAFE lockout 4", (2) BS01 B-SAFE lockout, (2) BS02 B-SAFE lockout, (1) M-SAFE nylon hasp, (2) Metal Lockout Hasp, (2) #3D Master Locks, (2) #1DLJ Master Locks, (10) DO NOT OPERATE TAGS / 25.

SKU	Description	UOM	Price
ARCLK109FE	Valve Lockout/Tagout Kit	EA	\$236.83



**C**

### D. Combination Lockout Kit

North has combined Electrical - Valves - Hasps - Tags – Locks into a convenient kit for employees to properly lockout /tagout most applications.

Includes: (2) Nylon carrying bags, (6) CB01 C-SAFE circuit breaker lockouts, (6) CB03 C-SAFE circuit breaker lockouts, (6) CB04 C-SAFE circuit breaker lockouts, (6) E-SAFE Lock-A-Switch, (1) E-SAFE lockout 110-220 volts, (1) E-SAFE lockout 220-550 volts, (2) V-SAFE lockout 2", (2) V-SAFE lockout 4", (2) BS01 B-SAFE lockout, (2) M-SAFE nylon hasp, (2) Metal Lockout Hasp, (6) #3D Master Locks, (6) #1DLJ Master Locks, (25) DO NOT OPERATE TAGS / 25.

SKU	Description	UOM	Price
ARCLK110FE	Combination Lockout Kit	EA	\$571.26



**D**

### E. Electrical Lockout Pouch

For convenient Electrical Lockout/Tagout North has created a zipper pouch that can be easily carried on your belt with all the necessary products. This ensures you or your workers have their lockouts when they need them.

Includes: (1) Double belt loop zippered pouch, (3) E-SAFE Lock-A-Switch, (1) E-SAFE lockout 110-220 volts, (4) CB04 C-SAFE circuit breaker lockouts, (4) CB03 C-SAFE circuit breaker lockouts, (1) CB02 C-SAFE circuit breaker lockouts, (2) CB01 C-SAFE circuit breaker lockouts.

SKU	Description	UOM	Price
ARCLK111FE	Electrical Lockout Pouch	EA	\$78.51



**E**



# Honeywell

North offers convenient and high visibility Lockout / Tagout centers that make your Locks, Tags, Lockout Hasps and Lockout devices (V-SAFE, B-SAFE, C-SAFE and E-SAFE and M-SAFE Hasps) easy to find and use. These Lockout / Tagout centers are built for the toughest conditions. They are made of double molded polystyrene with plastic or metal hanging hooks for locks and lockout hasps.

### A. Small Lockout/Tagout Station (18" x 24")

Contains: 1 ea. lockout panel, 2 ea. V-SAFE lockout 2", 1 ea. V-SAFE lockout 4", 1 ea. V-SAFE lockout 6", 1 ea. B-SAFE lockout, 2 ea. E-SAFE lockout 110-220 volts, 1 ea. E-SAFE lockout 220-550 volts, 4 ea. M-SAFE metal hasp, 1 ea. M-SAFE nylon hasp, 1 ea. DO NOT OPERATE TAGS / 25, 1 ea. DO NOT OPEN TAGS / 25 and 1 ea. 3D Master lock.

SKU	Description	UOM	Price
ARKLSE101F	Small Lockout/Tagout Station	EA	\$204.03

A



B

### B. Large Lockout/Tagout Station (24" x 35")

Contains: 1 ea. lockout panel, 2 ea. V-SAFE lockout 2", 1 ea. V-SAFE lockout 4", 1 ea. V-SAFE lockout 6", 1 ea. V-SAFE lockout 9", 1 ea. B-SAFE lockout, 1 ea. B-SAFE lockout, 2 ea. E-SAFE lockout 110-220 volts, 1 ea. E-SAFE lockout 220-550 volts, 2 ea. M-SAFE metal hasp, 6 ea. M-SAFE nylon hasp, 1 ea. DO NOT OPERATE TAGS / 25, 1 ea. DO NOT START TAGS / 25, 1 ea. DO NOT OPEN TAGS / 25, 2 ea. 3D Master lock and 2 ea. 3DLF Master lock.

SKU	Description	UOM	Price
ARKLSE102F	Large Lockout/Tagout Station	EA	\$415.28



### C. Personal Lockout Station (11" x 14")

Contains: 4 ea. 3D Master locks (Blue bumper padlock) and 1 pk. DO NOT OPERATE TAGS 25/Pack).

SKU	Description	UOM	Price
ARKLSE103F	Personal Lockout Station	EA	\$151.81

C



D

### D. Four Lockout Station (11" x 14")

Contains: 4 ea. 3D Master locks (Blue bumper padlock), 1 pk. DO NOT OPERATE TAGS (25/ Pack) and 3-1" safety lockout hasps.

SKU	Description	UOM	Price
ARKLSE104F	4 Lockout Station	EA	\$166.13



E

### E. 10 Lockout Station (14" x 21")

Contains: 10 ea. 3D Master locks (Blue bumper padlock), 2 pk. DO NOT OPERATE TAGS (25/ Pack) and 3-1" safety lockout hasps.

SKU	Description	UOM	Price
ARKLSE105F	10 Lockout Station	EA	\$342.00





### A. Lock Box

Simplifies lockout of large equipment. All keys for a machine are placed in a lock box. Then, each authorized work team member places a personal lock or tagout device to the group lock box, which ensures that no one employee has access to the box unless all employees have removed their locks or tags. Accepts up to 12 individual locks. Heavy steel, tamper resistant construction.

SKU	Description	UOM	Price
MAS498A	12 Lock group lock box	EA	\$54.97

# Honeywell

### B. Metal Dual Opening Lockout Hasps

Dual opening metal lockout hasp. The opens measure 1-3/4" in diameter and 3/4" in diameter. The dual scissor type hasp is 5-1/4" in length. Accommodates six padlocks and is made of tempered steel.

SKU	Description	UOM	Price
ARK666	Lockout hasps	EA	\$6.90

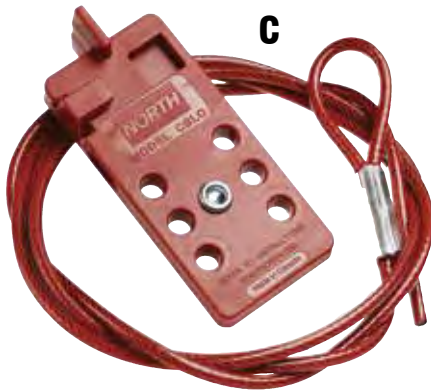
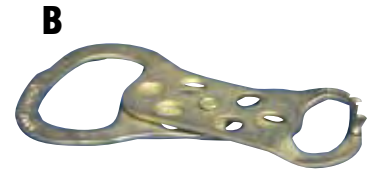

### C. Adjustable Cable Lockout

The adjustable cable lockout is infinitely adjustable for a secure fit every time. Simply feed the cable end through the points to be locked out, then back through the lockout body. The tough, multi-strand 3/16" steel cable is rated at 1,000 lbs. minimum pull strength at the weakest point, which prevents accidental energizations. Up to 6 workers can apply locks for increased security. Cable can be replaced with the versatile 10'; cable in the same lockout body.

SKU	Description	UOM	Price
ARKCBLOK06R	6' cable lockout device	EA	\$19.79
ARKCBL10	10' replacement cable	EA	\$12.10



### D. Original Hinge Box

Features an extra key strip used to enable user to double the number of keys inside of box. These are a snap-in design and can be removed if not wanted. An external slot, for the purpose of adding another key, if needed, without having to unlock all existing locks that are normally in use during a shutdown. Also, are four 1/4" mounting holes-spaced on 9-3/8" centers to facilitate hanging the box. Improved slot type center hasp gives a much better appearance, yet still offers the same protection as before when properly used.

SKU	Description	UOM	Price
SAAB21184Y	Original hinge box	EA	\$86.06

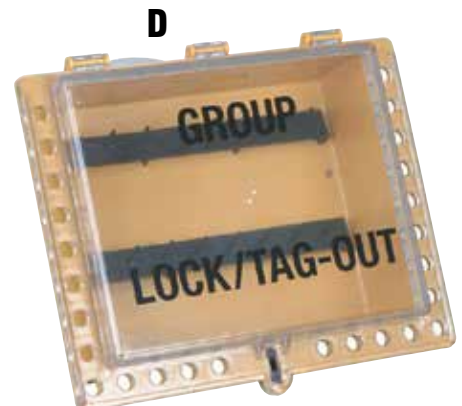

# Honeywell

## A. Nylon Lockout Hasps

This safety lock hasp has a heavy-duty nylon construction that is unbreakable and is resistant to heat and cold. The M-Safe design allows more than one worker to lock out the same energy source for added safety. Accepts up to six padlocks with shackle diameters up to 3/8" and is dielectric.

SKU	Description	UOM	Price
ARKMS01	M-Safe lockout hasp	EA	\$3.53

**A**



**B**

## B. Breaker Lockout

Single pole lockout, constructed of rigid plastic, snaps easily in place. ARKCB-01 requires a switch breaker with a recessed hole, accommodates breakers up to 9/16" width.

SKU	Description	UOM	Price
ARKCB-01	Circuit breaker lockout, single pole, 6/PK	PK	\$31.76
ARKCB-03	Circuit breaker lockout, single screw, 6/PK	PK	\$26.70
ARKCB-04	Circuit breaker lockout, double pole, 6/PK	PK	\$51.64

## C. Plug Lockout

LP110 will accept 110 volts and certain models of 220 volt. Accommodates a plug up to 1-3/4" x 1-3/4" x 3-1/4" in size with a maximum cable diameter of 1/2".

LP550 accepts 220 volt and 550 volt plugs up to 3" x 3" x 6 3/4" in size with a maximum cable diameter of 1.000"

SKU	Description	UOM	Price
ARKLP110	Lock-a-Plug, 110/220V	EA	\$9.37
ARKLP550	Lock-a-Plug, 220/550V	EA	\$12.04

**C**



**D**

## D. Electrical Switch Lockout

Locks a wall switch in the on/off position. Easy to install.

SKU	Description	UOM	Price
ARKES01	Electrical switch outlet, 6/PK	PK	\$37.83



# Lockout/Tagout

## Valve Lockouts

# Honeywell

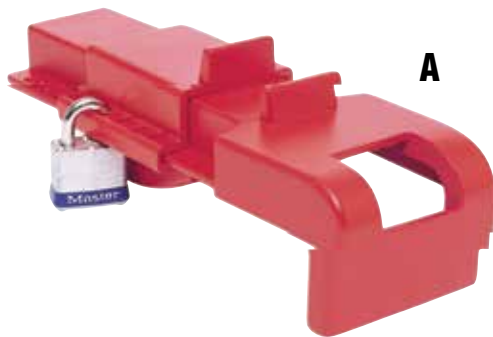

**A**

### A. Butterfly Valve Lockout

A universal lockout for butterfly valves. It is the only way to secure your butterfly valve efficiently. The lock hole is .375".

SKU	Description	UOM	Price
ARKBS-04	Butterfly valve lockout	EA	\$50.40

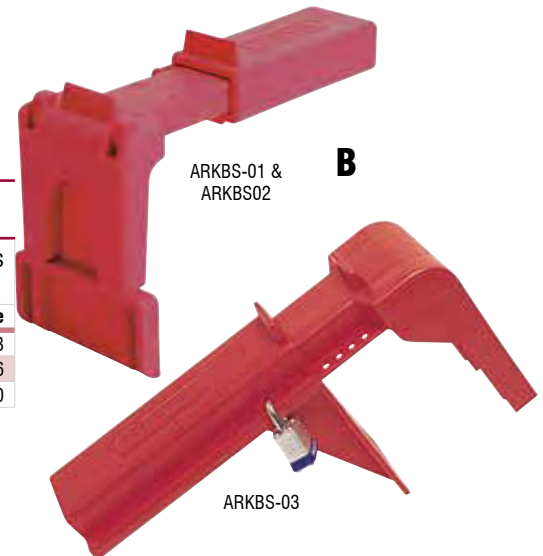

**B**

### B. Ball Valve Lockout

Lock Ball Valves safely, efficiently and inexpensively. Available in three sizes. The lock hole has a .312" (8mm) diameter.

SKU	Description	UOM	Price
ARKBS-01	Ball Valve Lockout from 3/8" - 1 1/4"	EA	\$16.03
ARKBS02	Ball Valve Lockout from 1 1/4" - 2 1/2"	EA	\$26.96
ARKBS-03	Ball Valve Lockout from 2" - 8"	EA	\$50.40

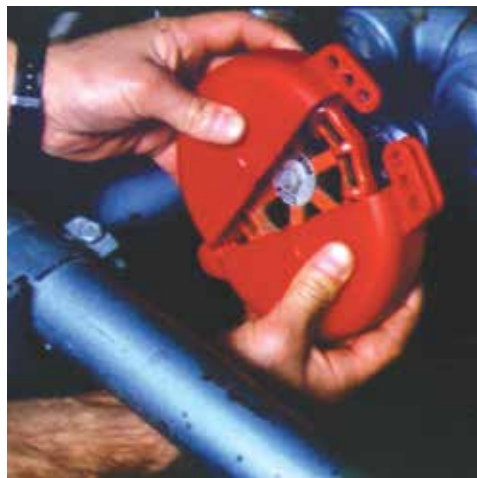

**C**

### C. Valve Lockout

Valve cover is made of strong polypropylene plastic, fully dielectric, highly-resistant to cracking abrasion, and to extreme temperature changes (from -50 °F to 360 °F).

SKU	Description	UOM	Price
ARKVS02	V-Safe valve cover - valve handle up to 2 1/2", red	EA	\$11.39
ARKVS04	V-Safe valve cover - valve handle 2 1/2" to 5", red	EA	\$16.99
ARKVS06	V-Safe valve cover - valve handle 5" to 6 1/2", red	EA	\$23.54
ARKVS09	V-Safe valve cover - valve handle 6 1/2" to 10", red	EA	\$28.07



## OSHA Standards

*Lockout/Tagout Standard (29CFR 1910.147) requires that all energy sources be turned off and "locked out" while machines are being serviced or maintained.*



# Hi Visibility Safety & PPE







## VISIBLE - SAFE - COMFORTABLE

Radians knows visibility is a safety requirement in high traffic areas, around heavy equipment, and in poorly lit work environments. Hard work in these difficult places calls for noticeable solutions.

GlenGuard<sup>®</sup> 



3M Scotchlite<sup>™</sup>  
Reflective Material



RADICALLY  
VISIBLE<sup>™</sup>



**ANSI/ISEA 107-2010 CLASS 2:** Background Fabric: 775 Square Inches;  
Reflective Material: 201 Square Inches; Minimum Reflective Width: 1.375 Inches

Ideal for workers who require greater visibility under inclement weather conditions - Or when work backgrounds are complex - Or when tasks divert attention from approaching vehicle traffic.

**APPLICATIONS:** Roadway construction workers / Utility workers / Survey crews / Railroad workers / School crossing guards / Airport baggage handlers / Law enforcement personnel / Emergency response personnel



**ANSI/ISEA 107-2010 CLASS 3:** Background Fabric: 1240 Square Inches;  
Reflective Material: 310 Square Inches; Minimum Reflective Width: 2 Inch

Ideal for workers and vehicle operators whose heavy task loads place them in danger - Or the wearer must be conspicuous through the full range of body motions at a minimum of 1,280 ft. - Or when wearer must be identifiable as a person.

**APPLICATIONS:** Roadway construction workers / Utility workers / Survey crews / Emergency response personnel



**ANSI/ISEA 207-2011 STANDARD:** Background Fabric: 450 Square Inches;  
Reflective Material: 201 Square Inches; Minimum Reflective Width: 2 Inch

The use of ANSI 207 Public Safety compliant garments is included as an option for emergency, incident responders and law enforcement officers to meet the requirements of the ANSI regulation in lieu of ANSI 107.

**APPLICATIONS:** Public Safety / Law Enforcement / First Responders



**FR ASTM 1506 and NFPA 701 STANDARDS:** FR ASTM 1506 and SE D6413 STANDARDS: Products that meet ASTM 1506 standards are inherently flame resistant, while SE D6413 products are chemically treated to make the base fiber flame retardant.

Ideal for any worker requiring high visibility and protection from flames, sparks, arc flashes and other possible introductions to flammable situations.

**APPLICATIONS:** Utility Workers / Welding / Public Safety / Oil Fields / First Responders / Petrochem Refining / Shipyards





## A. Economy Surveyor Vest Class 2 with Zipper Closure

These class 2 vests feature a zipper closure. It has a 2" silver tape reflective material. 1 horizontal stripe. Types of pockets include: 1 upper left front and 1 lower right inside. Made of 100% polyester mesh and come in hi-viz green or hi-viz orange.

SKU	Description	Color	Size	UOM	Price
MSV2ZO	Economy Class 2 with zipper closure	Orange	M-5X	EA	\$11.84
MSV2ZG	Economy Class 2 with zipper closure	Lime	M-5X	EA	\$11.84
MSV2OM	Economy Class 2 with hook and loop	Orange	M-5X	EA	\$10.17
MSV2GM	Economy Class 2 with hook and loop	Lime	M-5X	EA	\$10.17

A



B

## B. Two Tone Surveyor Vest Class 2

These class 2 vests feature a zipper closure. It has a 2" silver tape reflective material, 1 horizontal stripe and contrasting trim detail. Types of pockets include: 1 split pad/pencil, 1 radio, 2 each lower flap covered, 2 each deep inside pockets. Vest materials are 100% polyester knit front and 100% polyester mesh back and come in hi-viz green or hi-viz orange.

SKU	Description	Color	Size	UOM	Price
MSV6O	Two tone surveyor vest class 2	Orange	M-5X	EA	\$12.42
MSV6G	Two tone surveyor vest class 2	Lime	M-5X	EA	\$12.42

## C. Surveyor Class 2 Vests

These class 2 vests feature a zipper closure. It has a 2" silver tape reflective material. 1 horizontal stripe. Types of pockets include: 1 split pad/pencil, 1 radio, 2 each lower flap covered, 2 each deep inside pockets. Vest materials are 100% polyester knit front and 100% polyester mesh back and come in hi-viz green or hi-viz orange.

SKU	Description	Color	Size	UOM	Price
MSV7G	Class II Surveyor Vest	Lime	M-3XL	EA	\$11.84
MSV7O	Class II Surveyor Vest	Orange	M-3XL	EA	\$11.84

C



D

## D. Standard Class 2 Vests

Standard Class 2 vests for enhanced night time visibility. They feature front zipper closure, 2" silver tape reflective material, 2 horizontal stripes, 2 each upper outside pockets and 2 each lower inside pockets.

SKU	Description	Color	Size	UOM	Price
MSV8GM	Standard Class 2 vest mesh	Lime	S-3X	EA	\$12.09
MSV8OM	Standard Class 2 vest solid	Orange	S-3X	EA	\$12.09
MSV8GS	Standard Class 2 vest mesh	Lime	S-3X	EA	\$12.09
MSV8OS	Standard Class 2 vest solid	Orange	S-3X	EA	\$12.09



### A. Surveyor Class 2 Vest Heavy Duty Solid Twill

The SV62 Class 2 Surveyor Heavy Duty Safety Vest with Solid Twill Material has reflective stripes on contrasting trim to make workers much more noticeable in low light and broad daylight. Very functional pocket configuration so you can carry the tools you need to do your job. Heavy duty twill material for improved durability. This vest features zipper closure, 2" silver tape reflective material, 1 horizontal stripe, contrasting trim detail, upper split pad/pencil pocket, upper radio/phone pocket, 2 each lower pockets, flap covered, 2 large deep open inside, 1 inside flashlight and mic tab on both shoulders. 3rd Party Certified – Meets ANSI/ISEA 107-2010 Standards.

SKU	Description	Color	Size	UOM	Price
MSV6222G	Surveyor class 2 vest heavy duty solid twill	Lime	M-5X	EA	\$16.36
MSV6222O	Surveyor class 2 vest heavy duty solid twill	Orange	M-5X	EA	\$16.36

### B. Surveyor Class 2 Breakaway Safety Vest

The SV46 Surveyor Class 2 Breakaway Safety Vest has Zip-N-Rip™ closure at shoulders, sides and front zipper closure that breakaway when tugged with moderate force. Excellent choice for extreme work environments around moving machinery and equipment to prevent pulling workers into hazards. Contrast trim combinations make workers much more noticeable in low light and broad daylight conditions. This vest features an upper split pad/pencil, upper radio/phone, 2 each lower flap covered, 2 large deep open inside, 1 inside flashlight and mic tab on both shoulders. 3rd Party Certified – Meets ANSI/ISEA 107-2010 standards.

SKU	Description	Color	Size	UOM	Price
MSV46G	Surveyor class 2 breakaway safety vest	Lime	M-5X	EA	\$16.40
MSV46O	Surveyor class 2 breakaway safety vest	Orange	M-5X	EA	\$16.40



### C. Economy Class 2 Breakaway Safety Vest

The SV4 has hook & loop fasteners at shoulders, sides and front closure that breakaway when tugged with moderate force. Excellent choice for extreme work environments around moving machinery and equipment to prevent pulling workers into hazards. This vest features 2" silver tape reflective material; 1 horizontal stripe, 5 point breakaway; shoulders, sides and front closure and 100% polyester mesh pockets; 1 upper & lower left inside and 1 lower right outside. 3rd Party Certified – Meets ANSI/ISEA 107-2010 standards.

SKU	Description	Color	Size	UOM	Price
MSV46M	Economy class 2 breakaway safety vest	Lime	M-5X	EA	\$10.00
MSV40M	Economy class 2 breakaway safety vest	Orange	M-5X	EA	\$10.00

### D. Economy Vest Class 2 with Two-Tone Trim

The SV22-2 Economy Class 2 Safety Vest with Two-Tone Trim is compliant protection at an economical price. Excellent choice for extreme work environments like asphalt paving that greatly reduce the useful life of a vest, or protection for short-term labor. Reflective stripes on contrasting trim make workers much more noticeable in low light and broad daylight. This vest features zipper closure, 2" silver tape reflective material, 1 horizontal stripe, contrasting trim detail, 1 upper left front pocket and 1 lower right inside pocket. 3rd Party Certified – Meets ANSI/ISEA 107-2010 Standards.

SKU	Description	Color	Size	UOM	Price
MSV222G	Economy vest class 2 with two-tone trim	Lime	M-5X	EA	\$9.02
MSV222O	Economy vest class 2 with two-tone trim	Orange	M-5X	EA	\$9.02





### A. Anti-Static Modacrylic FR Class 2 Vest

This Anti-Static Modacrylic FR safety vest is intended for prevention of high visibility and FR hazards that also require anti-static resistance. Anti static properties are enhanced utilizing GlenGuard® Trilobal Carbon Fiber technology. Typical applications would be environments with flammable vapors, such as transferring flammable liquids, or other work environments that contain a flammable atmosphere. 3M Scotchlite FR Reflective Tape 8935 and Hook & Loop Closure. 94% FR Modacrylic, 5% Aramid, 1% Carbon Grid Anti-Stat. Meets ASTM F1506 and FTS 191A Method 5903. Fabric Certified to ANSI 107-2010 Level 2 and EN-471 Class 2 Retro Reflective Performance. EN-471 Class 2 Retro Reflective Performance.

SKU	Description	Color	Size	UOM	Price
MSV92ASG	Vest anti-static modacrylic FR class 2	Lime	M-XL	EA	\$69.55
MSV92ASG2X	Vest anti-static modacrylic FR class 2	Lime	2X	EA	\$76.50
MSV92ASG3X	Vest anti-static modacrylic FR class 2	Lime	3X	EA	\$83.34
MSV92ASG4X	Vest anti-static modacrylic FR class 2	Lime	4X	EA	\$90.42



### B. Basic Modacrylic FR Class 2 Vest

Radians Sport's Modacrylic FR safety vest is perfect when ultimate safety is required. Not only do these safety vests offer the flame resistant properties required by ANSI 107-2010, but also certified background and reflective material. They are perfect for the Utility Industry, or anywhere ultimate safety is required. 5.5 oz. 95% Modacrylic & 5% Twaron Material. 3M Scotchlite FR Reflective Tape 8935 and Hook & Loop Closure. Meets ASTM F1506 and FTS 191A Method 5903. Fabric Certified to ANSI 107-2010 Level 2 and EN-471 Class 2 Retro Reflective Performance. Meets & Exceeds NFPA 1971, 2000 Edition, Sections 5-1.4 and 6.2. ARC Rating 5.4 Cal/CM2.

SKU	Description	Color	Size	UOM	Price
MSV922VGSFR	Vest basic modacrylic FR class 2	Lime	M-XL	EA	\$64.79
MSV922VGSFR2	Vest basic modacrylic FR class 2	Lime	2X	EA	\$68.67
MSV922VGSFR3	Vest basic modacrylic FR class 2	Lime	3X	EA	\$72.52
MSV922VGSFR4	Vest basic modacrylic FR class 2	Lime	4X	EA	\$76.42
MSV922VGSFR5	Vest basic modacrylic FR class 2	Lime	5X	EA	\$80.27

### C. Economy Surveyor FR Vest Class 2

ANSI 107 Compliant FR protection at an economical price. Excellent choice for extreme work environments like petro-chem, asphalt paving, short-term labor, and welding where a Non-Durable FR level of protection is sufficient. Features include: zipper closure, 2" silver tape reflective material, 1 horizontal stripe, 1 Upper Left Front pocket and 1 Lower Right Inside pocket.

SKU	Description	Color	Size	UOM	Price
MSV25L	Heavy Duty Surveyor Class 2 vest	Lime	S-5X	EA	\$13.24
MSV25O	Heavy Duty Surveyor Class 2 vest	Orange	S-5X	EA	\$13.24



### D. Class 2 Flame-Resistant Two-Tone Trim Vest

The SV225 Economy Class 2 Flame-Resistant with Two-Tone Trim Safety Vest is ANSI 107 Compliant FR protection at an economical price. Excellent choice for extreme work environments like petro-chem, asphalt paving, short-term labor, and welding where a Non-durable FR\* level of protection is sufficient. Reflective stripes on contrasting trim make workers much more noticeable in low light and broad daylight. This vest features zipper closure, 2" silver tape reflective material, 1 horizontal stripe, contrasting trim detail, 1 upper left front pocket and 1 lower right inside pocket. Material: NFPA 701 (2004) Treated Fabric, 100% Polyester Mesh. 3rd Party Certified – Meets ANSI/ISEA 107-2010 Standards.

SKU	Description	Color	Size	UOM	Price
MSV225G	Class 2 FR two-tone trim vest	Lime	M-5X	EA	\$12.25
MSV225O	Class 2 FR two-tone trim vest	Orange	M-5X	EA	\$12.33





**A**

### A. Heavy Duty Surveyor Vest Class 2 Vests

Heavy Duty Contractor Surveyor's vest with large back "plan" pocket. Built with rugged ANSI 107 HiViz material, reinforced wear points, and long-wearing web reinforcement along outer edges. Mesh upper, front and back, for breathability and comfort. Pockets in tough woven twill fabric provide maximum durability.

SKU	Description	Color	Size	UOM	Price
MSV592ZGD	Heavy Duty Surveyor Class 2 vest	Lime	S-5X	EA	\$20.20
MSV592ZOD	Heavy Duty Surveyor Class 2 vest	Orange	S-5X	EA	\$20.20

### B. Economy Vest Class 3 with Two-Tone Trim

The SV22-3 Economy Class 3 with Two-Tone Trim is compliant protection at an economical price. Excellent choice for extreme work environments like asphalt paving that greatly reduce the useful life of a vest, or protection for short-term labor. Reflective stripes on contrasting trim make workers much more noticeable in low light and broad daylight. This vest features zipper closure, 2" silver tape reflective material, 1 horizontal stripe, contrasting trim detail, 1 upper left front pocket and 1 lower right inside pocket.

SKU	Description	Color	Size	UOM	Price
MSV223G	Economy vest class 3 with two-tone trim	Lime	M-5X	EA	\$14.02
MSV223O	Economy vest class 3 with two-tone trim	Orange	M-5X	EA	\$14.02



**B**



**C**

### C. Heavy Duty Surveyor Vest Class 3

Heavy Duty Contractor Surveyor's vest with large back "plan" pocket. Built with rugged ANSI 107 HiViz material, reinforced wear points, and long-wearing web reinforcement along outer edges. Mesh upper and sleeves, front and back, for breathability and comfort. Pockets in tough woven twill fabric provide maximum durability.

SKU	Description	Color	Size	UOM	Price
MSV593ZGD	Heavy Duty Surveyor Class 3 vest	Lime	S-5X	EA	\$29.42
MSV593ZOD	Heavy Duty Surveyor Class 3 vest	Orange	S-5X	EA	\$29.42

### D. Short Sleeved Two Tone Surveyor Class 3 Vest

Short sleeved Surveyor Class 3 safety vest. Perfect to be worn in daytime conditions. Contrast trim combinations make workers much more noticeable in low light and broad daylight. Very functional pocket configuration so you can carry the tools you need to do your job. These class 3 vests feature a zipper closure. It has a 2" silver tape reflective material, 1 horizontal stripe and contrasting trim detail. Types of pockets include: upper split pad/pencil, upper radio/phone, 2 each lower flap covered, 2 large deep open inside, 1 inside flashlight and mic tab on both shoulders. Vest materials are 100% polyester knit front and 100% polyester mesh back and come in hi-viz green or hi-viz orange.

SKU	Description	Color	Size	UOM	Price
MSV63G	Short Sleeved Two Tone Surveyor Class 3 Vest	Lime	M-5XL	EA	\$17.92
MSV63O	Short Sleeved Two Tone Surveyor Class 3 Vest	Orange	M-5XL	EA	\$17.92



**D**



**A**

### A. Standard Class 3 Vest

These class 3 safety vests feature a zipper closure, 2" Silver Tape Reflective Material and 2 horizontal stripes. It has 2 each upper outside pockets, 2 each lower inside pockets and 2 each upper inside pockets. It is made 100% solid knit polyester and comes in hi-viz lime green and orange.

SKU	Description	Color	Size	UOM	Price
MSV83GS	Standard poly knit class 3 vest	Lime	M-5XL	EA	\$13.42
MSV83OS	Standard poly knit class 3 vest	Orange	M-5XL	EA	\$13.42



**B**

### B. Non Rated Vests - 1" Tape

These vest have an adjustable front closure with hook and loop material and come in Hi-Viz Green or Hi-Viz Orange. They are made of lightweight, highly visible 100% polyester mesh with durable elastic side straps. Maintains brightness up to 25 washings. This model includes 1" reflective green or silver stripes on front and back for increased visibility or night work. Does NOT meet the ANSI/ISEA requirements.

SKU	Description	Size	UOM	Price
MSV01XL	Orange economy vest, lime green reflective stripes	S-XL	EA	\$3.78
MSV012-5X	Orange economy vest, lime green reflective stripes	2X-5X	EA	\$6.75
MSVG1XL	Lime green economy vest, silver reflective stripes	S-XL	EA	\$3.77
MSVG12-5X	Lime green economy vest, silver reflective stripes	2X-5X	EA	\$6.75

### C. Hi-Vis Short Sleeve T-Shirts Class 2

This class 2 safety T-shirt with Moisture Wicking Mesh is made with an arid Birdseye Mesh allowing for maximum breathability, without compromising durability. The stripes are adhered by heat transfer rather than sewn on, making the safety T-Shirt wear much more like a regular T-Shirt. The wicking properties improve hot weather comfort, making it feel much cooler. The front pocket does not include reflective material to allow for corporate imprints.

SKU	Description	Size	UOM	Price
MST112PGS	T-Shirt class 2 short sleeve lime green	M-5X	EA	\$12.80
MST112POS	T-Shirt class 2 short sleeve orange	M-5X	EA	\$12.80



**C**



**D**

### D. Hi-Vis Long Sleeve T-Shirts Class 3

This safety T-Shirt is made with an arid Birdseye Mesh allowing for maximum breathability, without compromising durability. The stripes are adhered by heat transfer rather than sewn on, making the safety T-shirt wear much more like a regular T-shirt. The wicking properties improve hot weather comfort making it feel much cooler. The front pocket does not include reflective material to allow for corporate imprints

SKU	Description	Color	Size	UOM	Price
MSCST213PG	T-Shirt class 3 long sleeve	Lime	M-5X	EA	\$20.10
MSCST213PO	T-Shirt class 3 long sleeve	Orange	M-5X	EA	\$20.10

### E. Short Sleeve Polo Class 2 Hi-Viz

This safety Polo is made with an arid Birdseye Mesh allowing for maximum breathability, without compromising durability. The stripes are adhered by heat transfer rather than sewn on, making the safety Polo extremely comfortable. The wicking properties improve hot weather comfort making it feel much cooler. The front pocket does not include reflective material to allow for corporate imprints. 3rd Party Certified – Meets ANSI/ISEA 107-2010 Standards.

SKU	Description	Color	Size	UOM	Price
MSCST122G	Short sleeve polo class 2 hi-viz	Lime	M-5X	EA	\$16.67
MSCST122O	Short sleeve polo class 2 hi-viz	Orange	M-5X	EA	\$16.67



**E**



**A**

### A. Long Sleeve Polo Class 2 Hi-Viz

This safety Polo is made with an arid Birdseye Mesh allowing for maximum breathability, without compromising durability. The stripes are adhered by heat transfer rather than sewn on, making the safety Polo extremely comfortable. The wicking properties improve hot weather comfort making it feel much cooler. The front pocket does not include reflective material to allow for corporate imprints. 3rd Party Certified – Meets ANSI/ISEA 107-2010 Standards.

SKU	Description	Color	Size	UOM	Price
MSCST222G	Long sleeve polo class 2 hi-viz	Lime	M-5X	EA	\$20.62
MSCST222O	Long sleeve polo class 2 hi-viz	Orange	M-5X	EA	\$20.62

### B. Long Sleeve Hooded Sweatshirt Class 3

Radians SJ01-3 Class 3 Long Sleeve Hooded Sweatshirt offers superior warmth while keeping you visible. Hood is lined with double, birds-eye mesh to maximize airflow and quickly dry moisture. This sweatshirt also features a black elastic knit waistband and cuffs, 2" silver reflective tape, full front zipper closure, two lower pouch pockets and mesh lined hood with adjustable pull cords. 3rd Party Certified – Meets ANSI/ISEA 107-2010 Standards.

SKU	Description	Color	UOM	Price
MSCSJ013ZGS	Sweatshirt with hood, class 3, hi-vis	Green	EA	\$38.00
MSCSJ013ZOS	Sweatshirt with hood, class 3, hi-vis	Orange	EA	\$38.00



**B**



**C**

### C. Bomber Jacket Hi-Viz Class 3 with Zip-Out Removable Jacket

Three-In-One Deluxe Bomber Jacket with zip out removable jacket. This class 3/level 2 bomber jacket features a PU coated polyester shell, fleece lined chest pocket, clear chest badge holder, concealed detachable hood, cell phone/radio chest pocket, mic tabs on both shoulders and two left sleeve pencil pockets. It has a yellow elasticized waistband, elasticized cuffs with closure and 2" silver reflective tape. Meets ANSI /ISEA 107-2004 standards.

SKU	Description	Color	UOM	Price
MSCSJ21G	Bomber jacket hi-viz class 3 with zip-out removable jacket	Lime	EA	\$57.93
MSCSJ21O	Bomber jacket hi-viz class 3 with zip-out removable jacket	Green	EA	\$57.93

### D. Hi-Viz Class 3 Parka 3-In-1 Wheaterproof

The Radians SJ41 Class 3, three-in-one weatherproof parka features a wind and water resistant shell and removable inner fleece jacket. It also features a 2" silver reflective tape and mic tabs on both shoulders. Four lower, fleece lined pockets with zipper, fleece lined chest pocket, hidden inside side pocket, two large inside pockets, concealed hood, pass through on back for fall protection and wrist cuffs with closure.

SKU	Description	UOM	Price
MSCSJ41G	Hi-Viz class 3 parka 3-in-1 wheaterproof	EA	\$95.00



**D**





### A. Radians SunShade Hard Hat Accessory

Lightweight cooling device. Protects neck by shading from harmful IV rays. FR: "Non-durable FR protection" is achieved by chemically treating a material that is not naturally flame-resistant, but becomes self-extinguishing after the treatment. Contrasting Trim Detail. NFPA 701 (2004) FR Treated 100% polyester mesh. Fits both cap style and full brim hard hats.

SKU	Description	UOM	Price
RADNSG	Hi-Viz yellow-green SunShade w/ reflective stripe (helmet not included)	EA	\$6.00
RADNSO	Hi-Viz orange SunShade w/reflective stripe (helmet not included)	EA	\$6.00



B



### B. GloWear® Class Headwear Hi-Vis Baseball Cap

Mesh venting and reflective trim. ANSI-certified 150D oxford polyester and .25" Level 2 ANSI-certified tape.

SKU	Description	UOM	Price
ERG8930LI	Baseball Cap Hi-Vis Lime	EA	\$7.24
ERG8930OR	Baseball Cap Hi-Vis Orange	EA	\$7.24

### C. GloWear® Class Headwear Hi-Vis Ranger Hat

Wide brim and vented mesh panels. ANSI-certified 150D oxford polyester and 1" Level 2 ANSI-certified tape with contrasting color.

SKU	Description	Size	UOM	Price
ERG8935LS/M	Ranger Hat Hi-Vis Lime	S/M	EA	\$10.49
ERG8935LL/XL	Ranger Hat Hi-Vis Lime	L/XL	EA	\$10.49
ERG8935OS/M	Ranger Hat Hi-Vis Orange	S/M	EA	\$10.49
ERG8935OL/XL	Ranger Hat Hi-Vis Orange	L/XL	EA	\$10.49



C



D

### D. Class 2 Adjustable Vests

ANSI 107-2004 Class 2 vest features Ultra-Cool mesh material for the ultimate in cool protection. Other features include: an inside pocket, adjustable snap front closure, 2" wide silver reflective tape, and protected clear ID pocket. Choose from orange or lime colors.

SKU	Description	Size	UOM	Price
KISB1049R	Lime Class 2 adjustable vest (Break-away)	Regular	EA	\$10.78
KISB1049XL	Lime Class 2 adjustable vest (Break-away)	XL	EA	\$10.78
KISB1049-3X	Lime Class 2 adjustable vest (Break-away)	3XL	EA	\$11.67
KISB1049-6X	Lime Class 2 adjustable vest (Break-away)	6XL	EA	\$13.48



### E. 3700 Series Vest

For the emergency response professional the 3700 incident command vest is loaded with features and maximum visibility. Features include: 1" white high intensity Reflexite® reflective tape, hook and loop closure, red poly/cotton fabric with matching trim, clear plastic card holder on back for 4-1/4" piece of paper, cardholder on front fits 3"x7", one large outside pocket with pencil division and one large inside pocket. Minimum purchase of 10 per color.

SKU	Description	Size	UOM	Price
KIS3703	Dark blue incident command vest	Universal	EA	\$15.00
KIS3705	Green incident command vest	Universal	EA	\$15.00
KIS3707	Orange incident command vest	Universal	EA	\$15.00
KIS3708	Red incident command vest	Universal	EA	\$15.00
KIS3711	White incident command vest	Universal	EA	\$15.00



E

Back

Front



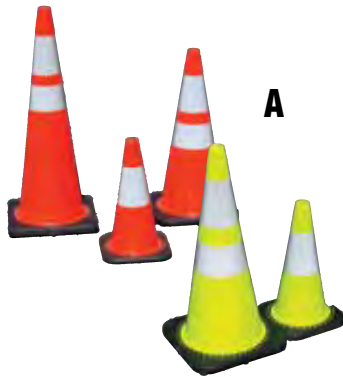

**A**

### A. Traffic Cones

Traffic cones are made of a brilliant fluorescent red-orange color to clearly outline hazards or work zones. Fluorescent red-orange color is ultraviolet stabilized for maximum resistance to fading. Cones are designed for maximum visibility under all weather conditions. One piece construction makes stacking these cones easy. They are flexible and feature a cleated base that holds them firmly in place.

SKU	Description	UOM	Price
SER2202444	Traffic Cone 36" 10# with collars orange	EA	\$23.79
WAP28PVCSCC	Traffic Cone 28" 7# with collars orange	EA	\$18.58
SER2202535	Traffic Cone 18" 3# with 6" collar orange	EA	\$11.06
JBCRS3008C3M	Traffic Cone 12" 1.8# with 4" collar orange	EA	\$9.79
JBCRS70032LR	Traffic Cone 28" 7# with collars lime	EA	\$21.32
WAP18PVCS	Traffic Cone 18" 3# no collar orange	EA	\$7.11
JBC45015C3LM	Traffic Cone 18" 3# with 6" collar lime	EA	\$12.17



### B. Retractable Cone Bar

The JBC Retractable Cone-Bar is designed for use with our PVC Traffic Cones. The Cone-Bar is extremely versatile for road trench or utility works use, construction sites, parking lots, pedestrian areas, and more.

SKU	Description	UOM	Price
JBCBARYB6	Cone-Bar expandable from 3' to 6' yellow/black	EA	\$21.66
JBCBARW010	Cone-Bar expandable from 5' to 10' white/orange	EA	\$33.55



**B**

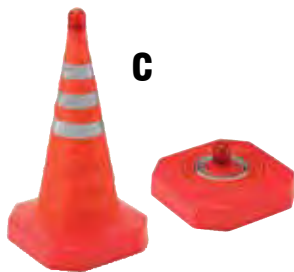

**C**

### C. Collapsible Traffic Cone

Portable, collapsible, 28" reflective cone is ideal for hazardous areas, police departments, school zones, industrial plants and for use by emergency responders. Collapses to 2" height and easily stores under the seat or in the trunk. Provides quick and easy set-up and take-down. Heavy duty, polyester cone construction resistant to most chemicals. Durable base is manufactured of heavy duty ABS. 6" & 4" reflective collars (permanently attached) and LED safety light (removable) provide additional visibility of 850' at night. Usable temperature is -40° F to 130° F.

SKU	Description	UOM	Price
COR03-500-80	Cone collapsible 28" W/LED orange	EA	\$25.30



### D. Reflective Highway Triangle Kit

Triangle reflector kit meets and exceeds all DOT standards and requirements of FMVSS 125. Ideal to keep in your vehicle in case of breakdown. The unique one-piece living hinge box allows for thousands of openings and closings and eliminates all hinge problems that the industry has faced for years. Includes 3 triangles. 17-1/4" W x 16-1/2" H x 17-1/8" L.

SKU	Description	UOM	Price
COR219-4	Reflect highway triangle kit	3/KT	\$25.22



**D**

### A. 2" Plastic Chain

Durable, strong and lightweight, this attractive plastic chain is intended for decorative purposes only. Unlimited life expectancy for use indoor and temporary lifespan in outdoor applications. This easy to use brightly colored chain adds to its popularity for crowd control applications. Supplied as 2" (link size). Not intended to support heavy objects; must not be used where a break might cause damage or injury.

SKU	Description	Length	Color	UOM	Price
MR50001-100	Plastic chain 2"	100 FT	White	BX	\$84.08
MR50001-500	Plastic chain 2"	500 FT	White	BX	\$420.42
MR50002-100	Plastic chain 2"	100 FT	Yellow	BX	\$84.08
MR50002-500	Plastic chain 2"	500 FT	Yellow	BX	\$420.42
MR50005-100	Plastic chain 2"	100 FT	Red	BX	\$84.08
MR50005-500	Plastic chain 2"	500 FT	Red	BX	\$420.42
MR500017-100	Plastic chain 2"	100 FT	Orange	BX	\$84.08
MR500017-500	Plastic chain 2"	500 FT	Orange	BX	\$458.64

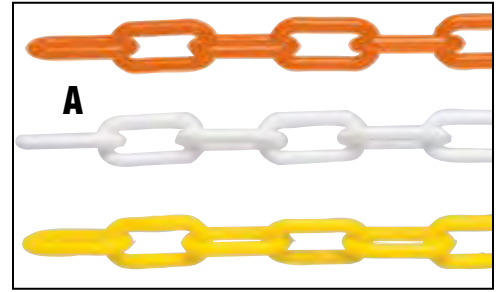

### B. Stanchion Sign Holder Adapter

The Sign Adapter allows you to attach a sign to your stanchion. Simply replace the ball top with the Sign Adapter and insert your sign. May accommodate signs up to 1/16" thick, 1.25" deep. Attaches to 3" diameter pole.

SKU	Description	Color	UOM	Price
MR93001	Sign holder adapter 3" dia	White	EA	\$31.92
MR93002	Sign holder adapter 3" dia	Yellow	EA	\$31.92
MR93005	Sign holder adapter 3" dia	Red	EA	\$31.92
MR93017	Sign holder adapter 3" dia	Orange	EA	\$5.79

### C. Traffic Stanchions

These heavy duty stanchions have a 32" pole (3" diameter), 4.5" ball top, 16" hollow base that can be filled with sand or gravel for extra stability. C-hook included.

SKU	Description	Color	UOM	Price
MR99901-4	Traffic Stanchion 3" dia heavy duty	White	EA	\$144.11
MR99902-4	Traffic Stanchion 3" dia heavy duty	Yellow	EA	\$144.11
MR99905-4	Traffic Stanchion 3" dia heavy duty	Red	EA	\$144.11
MR99917-4	Traffic Stanchion 3" dia heavy duty	Orange	EA	\$144.11
MR99945-4	Traffic Stanchion 3" dia. heavy duty DOT approved stripe	Orange/Silver	EA	\$243.92



MR99945-4



### D. Delineator Post & Base

Designed for maximum visibility, quick setup and low-maintenance, delineator post allows you to restrict access, identify hazards and direct traffic. Posts feature a "flare-bottom" design with one-inch wide right angle flare. Two 3" reflective collars insure visibility at low light levels. Delineator is 42" x 4" dia. Tested and certified to meet the crash worthy requirements of NCHRP- 350.

SKU	Description	UOM	Price
BENDT74223W	Delineator post & 12 lbs. base	EA	\$22.16

### E. Navicade Post & Base

The Navicade has a unique handle design with molded-in holes for mounting light and ropes. It can be used to rope work area. The snug fitting bases will not be knocked over by a car traveling down the roadway. Navicade is designed for easy placement and pick-up from a truck bed. Stackable for easy transportation or storage and is made of durable low-density polyethylene. Federal Highway Administration Approved, NCHRP 350 Compliant.

SKU	Description	UOM	Price
PLC650R104H	Navicade Post with 4" x 4" HIP stripes	EA	\$24.39
PLC650RB16	Navicade Post 16# base	EA	\$17.98
PLC650RB30	Navicade Post 30# base	EA	\$27.19



E

**PLASTICADE® PRODUCTS**



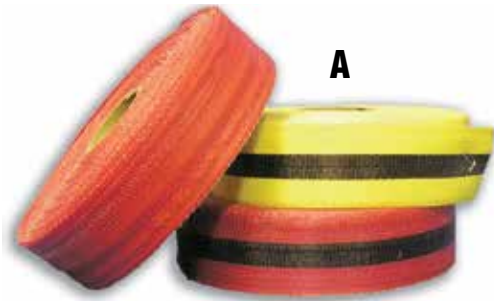

**A**

### A. Woven Barricade Tape

These 2" x 200' barricade tapes are made from woven polypropylene monofilament for extra strength and durability where you need it indoors or outdoors. Made to reuse as often as required.

SKU	Description	Size	Color	UOM	Price
ALLRB2200	Woven barricade tape	2" x 200'	Red/black	RL	\$7.49
ALLRED2200	Woven barricade tape	2" x 200'	Red/orange	RL	\$7.49
ALLYB2200	Woven barricade tape	2" x 200'	Black/yellow	RL	\$8.05

### B. Barrier Tape

Rugged 2 mil polyethylene barrier tape in high-visibility yellow or red provides identification and protection for above and below ground hazardous areas and elements such as high voltage cables, telecommunication lines, etc. 3" x 1,000 ft roll.

SKU	Description	Message	Color	UOM	Price
MSSDAN14998	Barrier tape	Danger	Red	RL	\$7.49
MSSCAU14995	Barrier tape	Caution	Yellow	RL	\$7.49
MSSDAN15212	Barrier tape	Danger do not enter	Red	RL	\$7.49
MSSCAU15123	Barrier tape	Caution men working overhead	Yellow	RL	\$12.56
MSSCAU15002	Barrier tape	Caution do not enter	Yellow	RL	\$7.49
MSSDAN15129	Barrier tape bilingual	Danger/peligro	Red	RL	\$7.49
MSSCAU15036	Barrier tape bilingual	Caution/cuidado	Yellow	RL	\$7.49



**B**



**C**

### C. Barricade Construction Hazard Tags

Tags meet OSHA's Lockout/Tagout standard (29CFR1910.47). Self-laminated to protect against weather and tampering and are metal-reinforced to withstand OSHA's 50 pound of tensile strength requirement. These tags are made of vinyl and come 25/pack.

SKU	Description	Color	UOM	Price
MSS120	Barricade construction hazard tag	Yellow with red letters	PK	\$16.48
MSS120A	Barricade construction hazard tag	Red with white letters	PK	\$16.48

### D. Rebar Caps

Patented Suprotek rebar covers protect employees against implements. The DONPC110 cover contains a curved steel plate, which provides additional protection against falls that occur from an angle. Cal. OSHA Approval #C7116AG. Meets Fed. OSHA Spec. #1926.701(b).

SKU	Description	Size	UOM	Price
DONPC110	Rebar cap	3-8	EA	\$2.22
DONPC200	Rebar cover	9-16	EA	\$3.47



**D**



### A. 48" Standard Roll-Up Signs

This 48" sign comes with fiberglass cross braces designed with plastic corner pockets that outlast all other designs and require less flexing to assemble. This makes the setup/break-down process quick and easy. Signs meet MUTCD specifications and are NCHRP-350 crash test approved when used with Dicke tripod or Uniflex stands. Available in non-reflective and reflective materials.

SKU	Description	Material	UOM	Price
DICRUNR48200	Be Prepared to Stop	Non-reflective	EA	\$65.71
DICRUNR482FL	Flagger Symbol	Non-reflective	EA	\$65.71
DICRUNR482ME	Men Working Symbol	Non-reflective	EA	\$65.71
DICRUNR482TR	Trucks Entering Highway	Non-reflective	EA	\$65.71
DICRUR48-200	Be Prepared to Stop	Reflective	EA	\$158.82
DICRUR48200F	Flagger Symbol	Reflective	EA	\$158.82
DICRUR482MEN	Men Working Symbol	Reflective	EA	\$158.82
DICRUR482TRU	Trucks Entering Highway	Reflective	EA	\$158.82



### B. Economy Tripod Sign Stand

This lightweight stand is made of durable, 1" O.D. galvanized mechanical tubing with no sharp edges. Displays 36" and 48" roll-up or rigid sign panels. Tripod design allows for quick and easy set-up. NCHRP-350 Test Level 2 compatibility with a roll-up sign panel. Crash test results available. Complies with MUTCD standards. Heavy duty model (DICT150) also available.

SKU	Description	UOM	Price
DICT50	Economy tripod stand, galvanized mechanical tubing	EA	\$43.92

### C. UniFlex™ Spring Loaded Sign Stand

Dicke's most versatile and economic compact spring stand features a vertical steel coil spring for windy conditions. The tripod displays both 36" and 48" roll-up signs and has a patented leg kick-release with two position height adjustment. The standard aluminum leg length is 30" and it telescopes to 51". The Uniflex stand meets the NCHRP-350 crash test standard when used with Dicke's roll-up signs.

SKU	Description	UOM	Price
DICUF2000W	UniFlex spring load sign stand	EA	\$156.29



### D. Stop/Slow Paddle Signs

Made of tough, durable, weatherproof aluminum. Paddle signs are lightweight and corrosion resistant.

SKU	Description	Size	Handle	Type	UOM	Price
SFSTSL18OCTR	Aluminum paddle signs reflective	18"	60"	Octagon	EA	\$57.25
SFSTSL18A-OC	Aluminum paddle signs	18"	10"	Octagon	EA	\$27.02
SFSTSL24OCT	Aluminum paddle signs	24"	60"	Octagon	EA	\$35.07
SFSTSL	Plastic paddle signs	18"	10"	Octagon	EA	\$19.23
SFST-SL-72	Paddle sign extension pole		72"		EA	\$7.45





**A**

### A. Air Horn

The Signal 8 oz horn kit complete with trumpet. This kit is 100% safe for the ozone and 100% nonflammable. Meets USCG requirements as a signal device. The trumpet is made of a high impact plastic.

SKU	Description	UOM	Price
50074005	Air horn	EA	\$16.89
50074022	Air horn canister refill	EA	\$13.67



**B**

### B. Air Horn Pump

Eco-Friendly no replacement cans or chemicals. This air horn pump is easy to use and meets U.S. Coast Guard requirements for boats up to 65', Patent Pending. Not just for boating, use at sporting events or for your auto.

SKU	Description	UOM	Price
500746311	Air horn pump kit	EA	\$16.04



**C**

### C. Whistle

Command attention with the chrome plated whistle.

SKU	Description	UOM	Price
WR85	Whistle	EA	\$1.62
LY85	Lanyard for whistle	EA	\$.68



### D. Windsock

Wind tunnel tested. Windsock is designed for conditions in which safety and wind direction are of greatest importance. Constructed of nylon oxford cloth for strength and fly ability. Dyed bright orange for higher visibility. Throat and tail bands of heavy-duty cotton duck stitched with multiple rows of tough synthetic thread. Throat band finished with #2 brass grommets for easy lacing onto frame. Unlike canvas or vinyl, nylon flies with the slightest breeze.

SKU	Description	Throat Dia.	Length	Color	UOM	Price
ARAW10361	Windsock	10"	3'	Orange	EA	\$14.90
ARAW18481	Windsock	18"	4'	Orange	EA	\$47.95
ARAW18601	Windsock	18"	5'	Orange	EA	\$49.70



**D**

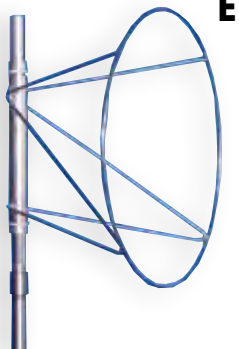

**E**

### E. Standard Unlighted Windsock Frame

Standard unlighted windsock frame is constructed of heavy-duty wire with sleeve and set collars. Zinc coated for weather protection and furnished with zinc coated pipe with standard threads for optional mounting. Rotates freely with no maintenance required.

SKU	Description	Frame Size	Sleeve ID	pipe OD	UOM	Price
ARAWF10	Unlighted windsock frame	10"	1 1/8"	1 1/16"	EA	\$58.68
ARAWF18	Unlighted windsock frame	18"	1 1/8"	1 1/16"	EA	\$94.53





### A. Wheel Chocks 450 Series

This wheel chock design is used by most utility and telephone fleets and allows either side of chock to be positioned against tire.

SKU	Description	Length	Width	Height	Weight	UOM	Price
CHECRC450	Rubber wheel chuck void bottom black	10"	8"	5.5"	7 lbs.	EA	\$19.25
CHECRC450-S	Rubber wheel chuck solid bottom black	10"	8"	5.5"	10 lbs.	EA	\$25.97

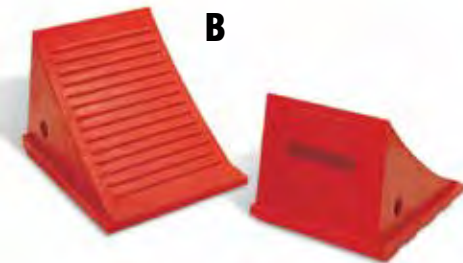
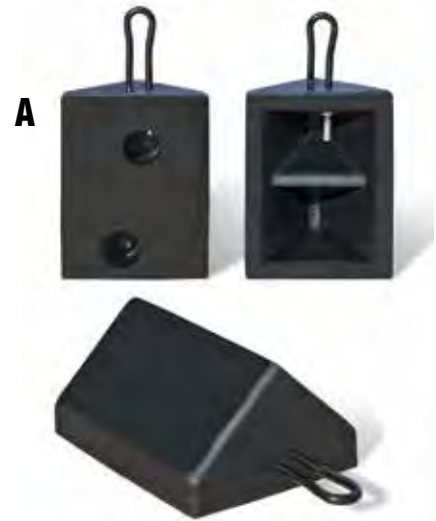

### B. Wheel Chocks 1500 Series

The 1500 Series wheel chocks feature a tough urethane construction that is oil and chemical resistant. It also has a recessed carrying handle and mounting hole for ropes or chains. Mounting brackets are available.

SKU	Description	Length	Width	Height	Weight	UOM	Price
CHECUC150045	Urethane wheel chuck orange	11"	7.75"	8"	4.5 lbs	EA	\$48.30
CHECUC15006	Urethane wheel chuck orange	11"	7.75"	8"	6 lbs	EA	\$56.49
CHECUC15HM	Horizontal mounting bracket series 1500				2.75 lbs	EA	\$45.32
CHECUC15VM	Vertical mounting bracket series 1500				2.25 lbs	EA	\$45.32

### C. Cable Protectors 5 Channel System

Protect valuable electrical cables, cords and hose lines from damage and abuse while ensuring a method of safe passage for vehicles and pedestrian traffic. Compact design is ideal for use in amusement parks, entertainment venues, sporting events, and in most public, commercial, industrial, construction, and utility applications.

SKU	Description	Length	Width	Height	Slot W X H	UOM	Price
CHECP5X125	Cable Protector 5 slot	36"	17.25"	1.96"	1.3" x 1.3"	EA	\$331.70
CHECPEC5X125	Cable Protector 5 slot end cap	4.75"	17.25"	1.95"	1.3" x 1.3"	EA	\$157.93

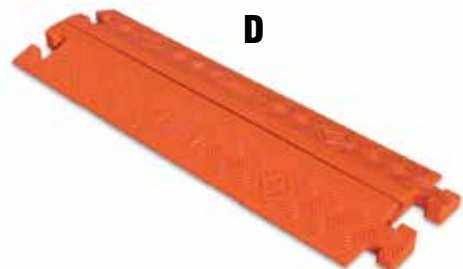

### D. Cable Protector 1 Channel System

Single Channel Systems protect valuable electrical cables, cords and hose lines from vehicle and foot traffic. Small, compact, low profile design allows for ease of storage and transport to job site. Popular with many utility, construction, and maintenance companies. Ideal for temporary re-routing of single cable and hose lines including fragile fiber optic telecommunications cable.

SKU	Description	Length	Width	Height	Slot Width	UOM	Price
CHECP1X125GP	Cable protector 1 open slot	36"	11.5"	1.6"	1.25"	EA	\$187.16
CHECP1X225GP	Cable protector 1 open slot	36"	14.25"	3"	2.25"	EA	\$269.80



**A**

### A. 275 Series Beacon

Applications include utility, construction, security and maintenance. Unique features include a whisper drive, a vacuum metallized reflector with a computer optimized beam pattern for improved visibility, an integrated low friction reflector drive module, an impact resistant polycarbonate lens, a patented quick bulb change system with phosphorous bronze contacts, and is water and dust-resistant. 12-volts DC. 2.2 pounds, 6.25" H x 6" D. SAE J845 and Class I Certified.

SKU	Description	UOM	Price
PSE660AH	Amber beacon w/9 ft. cord, magnetic	EA	\$103.59

### B. Star Flash IV

High-intensity strobe flashes 72 quad flashes per minute, perfect for construction equipment and other working class vehicles. Operates on 12 to 24V DC with 14 joule output. Low profile polycarbonate amber lens. Meets SAE Class 2 requirements. Made in USA.

SKU	Description	UOM	Price
PSELL400ASH	Star Flash IV amber strobe light	EA	\$167.67

**B**



### C. WhiteSound Back-Up Alarm

Back-up alarms are vital for vehicle safety, yet their very use can cause noise nuisance, irritating workers and neighbors, especially when used out of normal working hours. The White-Sound alarm emits a unique "shh...shh..." sound which solves the problem. These bbs-tek® alarms emit multi-frequency broadband sound, replacing the narrow frequency band of tonal beepers. It is directional, concentrating the sound in the danger area, thus reducing noise nuisance. Also, it is much safer than tonal beepers; its sound is instantly locatable so you immediately know which vehicle is reversing and where it is coming from. Broadband sound also dissipates more quickly beyond the danger zone, so it is much less of a nuisance to local residents and is less likely to be ignored by workers due to over exposure of tonal beepers.

SKU	Description	UOM	Price
BRGBBS82	Back-up alarm- 82 dB	EA	Call for pricing
BRGBBS87	Back-up alarm- 87 dB	EA	Call for pricing
BRGBBS92	Back-up alarm- 92 dB	EA	Call for pricing
BRGBBS97	Back-up alarm- 97 dB	EA	Call for pricing
BRGBBS102	Back-up alarm- 102 dB	EA	Call for pricing
BRGBBS107	Back-up alarm- 107 dB	EA	Call for pricing
BRGBBS97SA	Back-up alarm- 97 dB self adjusting	EA	Call for pricing
BRGBBS107SA	Back-up alarm- 107 dB self adjusting	EA	Call for pricing



**C**



### D. CCTV- Single Camera

Rear View CCTV is an essential aid to safe reversing. The ultimate fail-safe solution providing drivers with a clearer view of the area behind the vehicle and alerting them to dangers within blind spot areas. CCTV gives the driver a wider field of vision at the rear of the vehicle. Choose from the fantastic picture quality of the 4.5" monochrome monitor or 5" and 7" color monitor. Features backlit control buttons for ease of use at night. The compact monochrome camera includes six infra-red LEDs, while the color camera has 18 infra-red LEDs. Both systems are ideal when space is limited.

SKU	Description	Monitor Size	UOM	Price
BRGVBV545AM	Monochrome CCTV	4.5"	EA	Call for pricing
BRGVBV750M	Color CCTV	5"	EA	Call for pricing
BRGVBV770M	Color CCTV	7"	EA	Call for pricing

**D**



# Signs





The standards for basic sign requirements are covered under the Occupational Safety and Health Administration (OSHA 29 CFR § 1910.154), and the American National Standards Institute (ANSI Z535) provides specifications, design, application and use of Headers, Legends and Symbols. These signs are intended to indicate potential, type of degree of the hazard that may lead to accidental injury or property damage. They both define specific hazards by conveying a clear and rapidly understood message.

### Applicable Safety Sign Standards

**Occupations Safety & Health Administration:** OSHA 29 CFR 1910.145: Specifications for accident prevention signs.

**American National Standards Institute:** ANSI Z535.1, .2, .3, .4, .5, .6: Six standards that specify format, colors, and symbols for accident prevention safety signs. Recognized by OSHA.

### Safety Sign Header Markings



**DANGER** — Indicates an imminently hazardous situation which, if not avoided, **will** result in **death** or **serious injury**.

**WARNING** — Indicates a potentially hazardous situation which, if not avoided, **could** result in **death** or **serious injury**.

**CAUTION** — Indicates a potentially hazardous situation which, if not avoided, **could** result in **minor** or **moderate injury**.

**NOTICE** — Preferred signal word to address practices not related to personal injury.

**SAFETY FIRST, THINK, EMERGENCY** — Indicates general instructions relative to safe work practices or indicates the location of safety equipment.

### Basic Safety Sign Selections



#### Header

A "signal" word (or words) to designate the level of safety alertfulness required, always located in the uppermost portion of the sign. Intended to capture and direct attention to the potentially hazardous situation.

#### Legend

The specific short message conveys the need to pay attention to a potential hazard or hazards, or take a necessary action to avoid such hazard(s).

Many signs consist of just header and legend — Signs can also contain a symbol...



#### Symbol

Pictorials are graphic representations to clearly convey a specific alerting message compatible with and supplemental to the legend message. Universal in design and standardized to be easily understood.

### Safety Sign Materials

#### ADHESIVE VINYL (VS)

For light-duty applications. The ideal choice for indoor and sheltered outdoor marking needs. Mounts to all curved areas such as pipes, poles and secondary containers.

- 4-mil thick printed matte surface
- Permanent acrylic adhesive
- Moisture-resistant
- Service temperature range: -20°F to 140°F
- Durability: 2 years outdoors
- Square corners and scored backing for quick peel-off and application



#### PLASTIC (VP)

Semi-flexible, economical and appropriate for medium-duty use — ideal for indoor and sheltered outdoor environments.

- Ideal for flat surfaces with enough flex to mount on slightly curved areas
- .055" thick with good impact resistance and surface image with non-glare finish
- Contains UV inhibitors
- Service temperature range: -90°F to 168°F
- Durability: 2 years outdoors
- Rounded corners and 3/16" mounting holes
- Made from 50% recycled material



#### ALUMINUM (VA)

Get the strength of metal, without the rust. Superior abrasion and chemical resistance for indoor and outdoor environments.

- Printed image on rigid .040" aluminum backing
- Protected by high-gloss UV protective coating film
- Service temperature range: -20°F to 140°F
- Withstands splashes and washdowns
- Endures outdoor environmental conditions
- Rounded corners and 3/16" mounting holes

*Don't see what you're looking for? Additional materials and sizes are available. Call us for details.*

## Admittance & Exit



Mat'l	7" x 10"	10" x 14"
VS	AFMADM130VS	AFMADM006VS
VP	AFMADM130VP	AFMADM006VP
VA	AFMADM130VA	AFMADM006VA



7" x 10"	10" x 14"
AFMADM009VS	AFMADM008VS
AFMADM009VP	AFMADM008VP
AFMADM009VA	AFMADM008VA



7" x 10"	10" x 14"
AFMADM138VS	AFMADM139VS
AFMADM138VP	AFMADM139VP
AFMADM138VA	AFMADM139VA



7" x 10"	10" x 14"
AFMADM140VS	AFMADM141VS
AFMADM140VP	AFMADM141VP
AFMADM140VA	AFMADM141VA



7" x 10"	10" x 14"
AFMADM145VS	AFMADM146VS
AFMADM145VP	AFMADM146VP
AFMADM145VA	AFMADM146VA



Mat'l	7" x 10"	10" x 14"
VS	AFMATR111VS	AFMADM064VS
VP	AFMATR111VP	AFMADM064VP
VA	AFMATR111VA	AFMADM064VA



7" x 10"	10" x 14"
AFMADM292VS	AFMADM076VS
AFMADM292VP	AFMADM076VP
AFMADM292VA	AFMADM076VA



7" x 10"	10" x 14"
AFMADM148VS	AFMADM149VS
AFMADM148VP	AFMADM149VP
AFMADM148VA	AFMADM149VA



7" x 10"	10" x 14"
AFMADM067VS	AFMADM090VS
AFMADM067VP	AFMADM090VP
AFMADM067VA	AFMADM090VA



7" x 10"	10" x 14"
AFMADM322VS	AFMADM323VS
AFMADM322VP	AFMADM323VP
AFMADM322VA	AFMADM323VA



Mat'l	7" x 10"	10" x 14"
VS	AFMADM324VS	AFMADM325VS
VP	AFMADM324VP	AFMADM325VP
VA	AFMADM324VA	AFMADM325VA



7" x 10"	10" x 14"
AFMADM313VS	AFMADM304VS
AFMADM313VP	AFMADM304VP
AFMADM313VA	AFMADM304VA



7" x 10"	10" x 14"
AFMADM629VS	AFMADC600VS
AFMADM629VP	AFMADC600VP
AFMADM629VA	AFMADC600VA



7" x 10"	10" x 14"
AFMADM632VS	AFMADM636VS
AFMADM632VP	AFMADM636VP
AFMADM632VA	AFMADM636VA



7" x 10"	10" x 14"
AFMABR603VS	AFMABR607VS
AFMABR603VP	AFMABR607VP
AFMABR603VA	AFMABR607VA



Mat'l	7" x 10"	10" x 14"
VS	AFMABR613VS	AFMABR619VS
VP	AFMABR613VP	AFMABR619VP
VA	AFMABR613VA	AFMABR619VA



7" x 10"	10" x 14"
AFMABR624VS	AFMABR625VS
AFMABR624VP	AFMABR625VP
AFMABR624VA	AFMABR625VA



7" x 10"	10" x 14"
AFMADM882VS	AFMADM893VS
AFMADM882VP	AFMADM893VP
AFMADM882VA	AFMADM893VA



7" x 10"	10" x 14"
AFMADC800VS	AFMADC801VS
AFMADC800VP	AFMADC801VP
AFMADC800VA	AFMADC801VA



7" x 10"	10" x 14"
AFMABR826VS	AFMABR827VS
AFMABR826VP	AFMABR827VP
AFMABR826VA	AFMABR827VA



Mat'l	7" x 10"	10" x 14"
VS	AFMADC803VS	AFMADC804VS
VP	AFMADC803VP	AFMADC804VP
VA	AFMADC803VA	AFMADC804VA



7" x 10"	10" x 14"
AFMABR823VS	AFMABR825VS
AFMABR823VP	AFMABR825VP
AFMABR823VA	AFMABR825VA



7" x 10"	10" x 14"
AFMADC805VS	AFMADC806VS
AFMADC805VP	AFMADC806VP
AFMADC805VA	AFMADC806VA



7" x 10"	10" x 14"
AFMADM872VS	AFMADM808VS
AFMADM872VP	AFMADM808VP
AFMADM872VA	AFMADM808VA



7" x 10"	10" x 14"
AFMACC822VS	AFMACC821VS
AFMACC822VP	AFMACC821VP
AFMACC822VA	AFMACC821VA



Mat'l	7" x 10"	10" x 14"
VS	AFMATR802VS	AFMATR806VS
VP	AFMATR802VP	AFMATR806VP
VA	AFMATR802VA	AFMATR806VA



7" x 10"	10" x 14"
AFMADM810VS	AFMADM812VS
AFMADM810VP	AFMADM812VP
AFMADM810VA	AFMADM812VA



7" x 10"	10" x 14"
AFMADM401VS	AFMADM832VS
AFMADM401VP	AFMADM832VP
AFMADM401VA	AFMADM832VA



7" x 10"	10" x 14"
AFMADC807VS	AFMADC808VS
AFMADC807VP	AFMADC808VP
AFMADC807VA	AFMADC808VA



7" x 10"	10" x 14"
AFMASE806VS	AFMASE807VS
AFMASE806VP	AFMASE807VP
AFMASE806VA	AFMASE807VA

Material Code	Material	7" x 10"	10" x 14"
VS	Adhesive Vinyl	\$8.31	\$12.46
VP	Plastic	\$9.06	\$13.53
VA	Aluminum	\$12.95	\$21.51



**Admittance & Exit continued**



Mat'l	7" x 10"	10" x 14"
VS	AFMATR901VS	AFMATR900VS
VP	AFMATR901VP	AFMATR900VP
VA	AFMATR901VA	AFMATR900VA



7" x 10"	10" x 14"
AFMADM910VS	AFMADC520VS
AFMADM910VP	AFMADC520VP
AFMADM910VA	AFMADC520VA



7" x 10"	10" x 14"
AFMADM498VS	AFMADM499VS
AFMADM498VP	AFMADM499VP
AFMADM498VA	AFMADM499VA



7" x 10"	10" x 14"
AFMEXT584VS	AFMEXT918VS
AFMEXT584VP	AFMEXT918VP
AFMEXT584VA	AFMEXT918VA



7" x 10"	10" x 14"
AFMEXT554VS	AFMEXT552VS
AFMEXT554VP	AFMEXT552VP
AFMEXT554VA	AFMEXT552VA



Mat'l	7" x 10"	10" x 14"
VS	AFMEXT591VS	AFMEXT932VS
VP	AFMEXT591VP	AFMEXT932VP
VA	AFMEXT591VA	AFMEXT932VA



7" x 10"	10" x 14"
AFMADC531VS	AFMEXT906VS
AFMADC531VP	AFMEXT906VP
AFMADC531VA	AFMEXT906VA



7" x 10"	10" x 14"
AFMEXT562VS	AFMEXT518VS
AFMEXT562VP	AFMEXT518VP
AFMEXT562VA	AFMEXT518VA



7" x 10"	10" x 14"
N/A	AFMADC532VP
N/A	AFMADC532VP
N/A	AFMADC532VA



7" x 10"	10" x 14"
N/A	AFMADC534VS
N/A	AFMADC534VP
N/A	AFMADC534VA



Mat'l	7" x 10"	10" x 14"
VS	AFMADM486VS	AFMADC529VS
VP	AFMADM486VP	AFMADC529VP
VA	AFMADM486VA	AFMADC529VA



7" x 10"	10" x 14"
AFMATR516VS	AFMATR521VS
AFMATR516VP	AFMATR521VP
AFMATR516VA	AFMATR521VA



7" x 10"	10" x 14"
AFMEXT910VS	AFMEXT911VS
AFMEXT910VP	AFMEXT911VP
AFMEXT910VA	AFMEXT911VA



7" x 10"	10" x 14"
AFMADM419VS	AFMEXT444VS
AFMADM419VP	AFMEXT444VP
AFMADM419VA	AFMEXT444VA



7" x 10"	10" x 14"
AFMADM402VS	AFMADC530VS
AFMADM402VP	AFMADC530VP
AFMADM402VA	AFMADC530VA

**Chemicals & Hazardous Materials**



Mat'l	7" x 10"	10" x 14"
VS	AFMCHL196VS	AFMCHL174VS
VP	AFMCHL196VP	AFMCHL174VP
VA	AFMCHL196VA	AFMCHL174VA



7" x 10"	10" x 14"
AFMCHL189VS	AFMCHL190VS
AFMCHL189VP	AFMCHL190VP
AFMCHL189VA	AFMCHL190VA



7" x 10"	10" x 14"
AFMCAW013VS	AFMCAW107VS
AFMCAW013VP	AFMCAW107VP
AFMCAW013VA	AFMCAW107VA



7" x 10"	10" x 14"
AFMCHL075VS	AFMCHL010VS
AFMCHL075VP	AFMCHL010VP
AFMCHL075VA	AFMCHL010VA



7" x 10"	10" x 14"
AFMCHL191VS	AFMCHL192VS
AFMCHL191VP	AFMCHL192VP
AFMCHL191VA	AFMCHL192VA



Mat'l	7" x 10"	10" x 14"
VS	AFMCHL193VS	AFMCHL194VS
VP	AFMCHL193VP	AFMCHL194VP
VA	AFMCHL193VA	AFMCHL194VA



7" x 10"	10" x 14"
AFMCPG018VS	AFMCPG004VS
AFMCPG018VP	AFMCPG004VP
AFMCPG018VA	AFMCPG004VA



7" x 10"	10" x 14"
AFMCPG101VS	AFMCPG104VS
AFMCPG101VP	AFMCPG104VP
AFMCPG101VA	AFMCPG104VA



7" x 10"	10" x 14"
AFMCHL221VS	AFMCHL222VS
AFMCHL221VP	AFMCHL222VP
AFMCHL221VA	AFMCHL222VA



7" x 10"	10" x 14"
AFMCHL224VS	AFMCHL226VS
AFMCHL224VP	AFMCHL226VP
AFMCHL224VA	AFMCHL226VA



Mat'l	7" x 10"	10" x 14"
VS	AFMCHL268VS	AFMCHL270VS
VP	AFMCHL268VP	AFMCHL270VP
VA	AFMCHL268VA	AFMCHL270VA



7" x 10"	10" x 14"
AFMCHL228VS	AFMCHL231VS
AFMCHL228VP	AFMCHL231VP
AFMCHL228VA	AFMCHL231VA



7" x 10"	10" x 14"
AFMCHG101VS	AFMCHG102VS
AFMCHG101VP	AFMCHG102VP
AFMCHG101VA	AFMCHG102VA



7" x 10"	10" x 14"
AFMCHL186VS	AFMCHG052VS
AFMCHL186VP	AFMCHG052VP
AFMCHL186VA	AFMCHG052VA



7" x 10"	10" x 14"
AFMSMK251VS	AFMSMK243VS
AFMSMK251VP	AFMSMK243VP
AFMSMK251VA	AFMSMK243VA

Material Code	Material	7" x 10"	10" x 14"
VS	Adhesive Vinyl	\$8.31	\$12.46
VP	Plastic	\$9.06	\$13.53
VA	Aluminum	\$12.95	\$21.51





**Chemicals & Hazardous Materials continued**



Mat'l	7" x 10"	10" x 14"
VS	AFMCHL147VS	AFMSMK022VS
VP	AFMCHL147VP	AFMSMK022VP
VA	AFMCHL147VA	AFMSMK022VA



7" x 10"	10" x 14"
AFMCPG005VS	AFMCPG003VS
AFMCPG005VP	AFMCPG003VP
AFMCPG005VA	AFMCPG003VA



7" x 10"	10" x 14"
AFMCHL241VS	AFMCHL245VS
AFMCHL241VP	AFMCHL245VP
AFMCHL241VA	AFMCHL245VA



7" x 10"	10" x 14"
AFMCHL054VS	AFMCHL038VS
AFMCHL054VP	AFMCHL038VP
AFMCHL054VA	AFMCHL038VA



7" x 10"	10" x 14"
AFMCHL177VS	AFMCHG078VS
AFMCHL177VP	AFMCHG078VP
AFMCHL177VA	AFMCHG078VA



Mat'l	7" x 10"	10" x 14"
VS	AFMCHL288VS	AFMCHL295VS
VP	AFMCHL288VP	AFMCHL295VP
VA	AFMCHL288VA	AFMCHL295VA



7" x 10"	10" x 14"
AFMCHL127VS	AFMCHL125VS
AFMCHL127VP	AFMCHL125VP
AFMCHL127VA	AFMCHL125VA



7" x 10"	10" x 14"
AFMCHL173VS	AFMCHL175VS
AFMCHL173VP	AFMCHL175VP
AFMCHL173VA	AFMCHL175VA



7" x 10"	10" x 14"
AFMCHL168VS	AFMCHL170VS
AFMCHL168VP	AFMCHL170VP
AFMCHL168VA	AFMCHL170VA



7" x 10"	10" x 14"
AFMCAW100VS	AFMCAW109VS
AFMCAW100VP	AFMCAW109VP
AFMCAW100VA	AFMCAW109VA



Mat'l	7" x 10"	10" x 14"
VS	AFMCHL083VS	AFMCHL206VS
VP	AFMCHL083VP	AFMCHL206VP
VA	AFMCHL083VA	AFMCHL206VA



7" x 10"	10" x 14"
AFMCPG025VS	AFMCHL200VS
AFMCPG025VP	AFMCHL200VP
AFMCPG025VA	AFMCHL200VA



7" x 10"	10" x 14"
AFMWLD009VS	AFMWLD017VS
AFMWLD009VP	AFMWLD017VP
AFMWLD009VA	AFMWLD017VA



7" x 10"	10" x 14"
AFMBHZ303VS	AFMBHZ300VS
AFMBHZ303VP	AFMBHZ300VP
AFMBHZ303VA	AFMBHZ300VA



7" x 10"	10" x 14"
AFMCAW302VS	AFMSMK027VS
AFMCAW302VP	AFMSMK027VP
AFMCAW302VA	AFMSMK027VA



Mat'l	7" x 10"	10" x 14"
VS	AFMELC636VS	AFMELC640VS
VP	AFMELC636VP	AFMELC640VP
VA	AFMELC636VA	AFMELC640VA



7" x 10"	10" x 14"
AFMCHL652VS	AFMCHL668VS
AFMCHL652VP	AFMCHL668VP
AFMCHL652VA	AFMCHL668VA



7" x 10"	10" x 14"
AFMELC642VS	AFMELC643VS
AFMELC642VP	AFMELC643VP
AFMELC642VA	AFMELC643VA



7" x 10"	10" x 14"
AFMCPG611VS	AFMCPG612VS
AFMCPG611VP	AFMCPG612VP
AFMCPG611VA	AFMCPG612VA



7" x 10"	10" x 14"
AFMCHL601VS	AFMCHL613VS
AFMCHL601VP	AFMCHL613VP
AFMCHL601VA	AFMCHL613VA



Mat'l	7" x 10"	10" x 14"
VS	AFMCHL633VS	AFMCHL674VS
VP	AFMCHL633VP	AFMCHL674VP
VA	AFMCHL633VA	AFMCHL674VA



7" x 10"	10" x 14"
AFMCPG802VS	AFMCPG805VS
AFMCPG802VP	AFMCPG805VP
AFMCPG802VA	AFMCPG805VA



7" x 10"	10" x 14"
AFMCPG804VS	AFMCPG816VS
AFMCPG804VP	AFMCPG816VP
AFMCPG804VA	AFMCPG816VA



7" x 10"	10" x 14"
AFMCPG800VS	AFMCPG825VS
AFMCPG800VP	AFMCPG825VP
AFMCPG800VA	AFMCPG825VA



7" x 10"	10" x 14"
AFMCAW808VS	AFMCAW800VS
AFMCAW808VP	AFMCAW800VP
AFMCAW808VA	AFMCAW800VA



Mat'l	7" x 10"	10" x 14"
VS	AFMCAW806VS	AFMCAW805VS
VP	AFMCAW806VP	AFMCAW805VP
VA	AFMCAW806VA	AFMCAW805VA



7" x 10"	10" x 14"
AFMCHL826VS	AFMCHL807VS
AFMCHL826VP	AFMCHL807VP
AFMCHL826VA	AFMCHL807VA



7" x 10"	10" x 14"
AFMCPG595VS	AFMCPG596VS
AFMCPG595VP	AFMCPG596VP
AFMCPG595VA	AFMCPG596VA



7" x 10"	10" x 14"
AFMCHL563VS	AFMCHL567VS
AFMCHL563VP	AFMCHL567VP
AFMCHL563VA	AFMCHL567VA



7" x 10"	10" x 14"
AFMCHL517VS	AFMCHL516VS
AFMCHL517VP	AFMCHL516VP
AFMCHL517VA	AFMCHL516VA

Material Code	Material	7" x 10"	10" x 14"
VS	Adhesive Vinyl	\$8.31	\$12.46
VP	Plastic	\$9.06	\$13.53
VA	Aluminum	\$12.95	\$21.51



## Confined Space



Mat'l	7" x 10"	10" x 14"
VS	AFMCSP116VS	AFMCSP002VS
VP	AFMCSP116VP	AFMCSP002VP
VA	AFMCSP116VA	AFMCSP002VA



7" x 10"	10" x 14"
AFMCSP140VS	AFMCSP141VS
AFMCSP140VP	AFMCSP141VP
AFMCSP140VA	AFMCSP141VA



7" x 10"	10" x 14"
AFMCSP006VS	AFMCSP230VS
AFMCSP006VP	AFMCSP230VP
AFMCSP006VA	AFMCSP230VA



7" x 10"	10" x 14"
AFMCSP133VS	AFMCSP134VS
AFMCSP133VP	AFMCSP134VP
AFMCSP133VA	AFMCSP134VA



7" x 10"	10" x 14"
AFMCSP015VS	AFMCSP014VS
AFMCSP015VP	AFMCSP014VP
AFMCSP015VA	AFMCSP014VA



Mat'l	7" x 10"	10" x 14"
VS	AFMCSP019VS	AFMCSP018VS
VP	AFMCSP019VP	AFMCSP018VP
VA	AFMCSP019VA	AFMCSP018VA



7" x 10"	10" x 14"
AFMCSP124VS	AFMCSP125VS
AFMCSP124VP	AFMCSP125VP
AFMCSP124VA	AFMCSP125VA



7" x 10"	10" x 14"
AFMCSP102VS	AFMCSP104VS
AFMCSP102VP	AFMCSP104VP
AFMCSP102VA	AFMCSP104VA



7" x 10"	10" x 14"
AFMCSP108VS	AFMCSP110VS
AFMCSP108VP	AFMCSP110VP
AFMCSP108VA	AFMCSP110VA



7" x 10"	10" x 14"
AFMCSP007VS	AFMCSP058VS
AFMCSP007VP	AFMCSP058VP
AFMCSP007VA	AFMCSP058VA

## Construction



Mat'l	7" x 10"	10" x 14"
VS	AFMCRT127VS	AFMCRT135VS
VP	AFMCRT127VP	AFMCRT135VP
VA	AFMCRT127VA	AFMCRT135VA



7" x 10"	10" x 14"
AFMCRT133VS	AFMCRT134VS
AFMCRT133VP	AFMCRT134VP
AFMCRT133VA	AFMCRT134VA



7" x 10"	10" x 14"
AFMCRT109VS	AFMCRT136VS
AFMCRT109VP	AFMCRT136VP
AFMCRT109VA	AFMCRT136VA



7" x 10"	10" x 14"
AFMCRT101VS	AFMADM014VS
AFMCRT101VP	AFMADM014VP
AFMCRT101VA	AFMADM014VA



7" x 10"	10" x 14"
AFMCRT153VS	AFMADM003VS
AFMCRT153VP	AFMADM003VP
AFMCRT153VA	AFMADM003VA



Mat'l	7" x 10"	10" x 14"
VS	AFMCRT123VS	AFMCRT122VS
VP	AFMCRT123VP	AFMCRT122VP
VA	AFMCRT123VA	AFMCRT122VA



7" x 10"	10" x 14"
AFMCRT153VS	AFMCRT154VS
AFMCRT153VP	AFMCRT154VP
AFMCRT153VA	AFMCRT154VA



7" x 10"	10" x 14"
AFMEQM193VS	AFMEQM208VS
AFMEQM193VP	AFMEQM208VP
AFMEQM193VA	AFMEQM208VA



7" x 10"	10" x 14"
AFMCRT013VS	AFMCRT008VS
AFMCRT013VP	AFMCRT008VP
AFMCRT013VA	AFMCRT008VA



7" x 10"	10" x 14"
AFMEQM061VS	AFMCRT016VS
AFMEQM061VP	AFMCRT016VP
AFMEQM061VA	AFMCRT016VA



Mat'l	7" x 10"	10" x 14"
VS	AFMSTF102VS	AFMCRT009VS
VP	AFMSTF102VP	AFMCRT009VP
VA	AFMSTF102VA	AFMCRT009VA



7" x 10"	10" x 14"
AFMSTF201VS	AFMCRT010VS
AFMSTF201VP	AFMCRT010VP
AFMSTF201VA	AFMCRT010VA



7" x 10"	10" x 14"
AFMEQM026VS	AFMEQM124VS
AFMEQM026VP	AFMEQM124VP
AFMEQM026VA	AFMEQM124VA



7" x 10"	10" x 14"
AFMEQD101VS	AFMCRT001VS
AFMEQD101VP	AFMCRT001VP
AFMEQD101VA	AFMCRT001VA



7" x 10"	10" x 14"
AFMCRT602VS	AFMEQM602VS
AFMCRT602VP	AFMEQM602VP
AFMCRT602VA	AFMEQM602VA

## Electrical



Mat'l	7" x 10"	10" x 14"
VS	AFMELC058VS	AFMELC059VS
VP	AFMELC058VP	AFMELC059VP
VA	AFMELC058VA	AFMELC059VA



7" x 10"	10" x 14"
AFMELC111VS	AFMELC112VS
AFMELC111VP	AFMELC112VP
AFMELC111VA	AFMELC112VA



7" x 10"	10" x 14"
AFMELC017VS	AFMELC018VS
AFMELC017VP	AFMELC018VP
AFMELC017VA	AFMELC018VA



7" x 10"	10" x 14"
AFMELC275VS	AFMELC022VS
AFMELC275VP	AFMELC022VP
AFMELC275VA	AFMELC022VA



7" x 10"	10" x 14"
AFMELC113VS	AFMELC114VS
AFMELC113VP	AFMELC114VP
AFMELC113VA	AFMELC114VA

Material Code	Material	7" x 10"	10" x 14"
VS	Adhesive Vinyl	\$8.31	\$12.46
VP	Plastic	\$6.06	\$13.53
VA	Aluminum	\$12.95	\$21.51



**Electrical continued**



Mat'l	7" x 10"	10" x 14"
VS	AFMELC029VS	AFMELC028VS
VP	AFMELC029VP	AFMELC028VP
VA	AFMELC029VA	AFMELC028VA



7" x 10"	10" x 14"
AFMELC132VS	AFMELC124VS
AFMELC132VP	AFMELC124VP
AFMELC132VA	AFMELC124VA



7" x 10"	10" x 14"
AFMELC127VS	AFMELC128VS
AFMELC127VP	AFMELC128VP
AFMELC127VA	AFMELC128VA



7" x 10"	10" x 14"
AFMELC050VS	AFMELC044VS
AFMELC050VP	AFMELC044VP
AFMELC050VA	AFMELC044VA



7" x 10"	10" x 14"
AFMELC146VS	AFMELC054VS
AFMELC146VP	AFMELC054VP
AFMELC146VA	AFMELC054VA



Mat'l	7" x 10"	10" x 14"
VS	AFMELC309VS	AFMELC308VS
VP	AFMELC309VP	AFMELC308VP
VA	AFMELC309VA	AFMELC308VA



7" x 10"	10" x 14"
AFMELC328VS	AFMELC329VS
AFMELC328VP	AFMELC329VP
AFMELC328VA	AFMELC329VA



7" x 10"	10" x 14"
AFMELC325VS	AFMELC326VS
AFMELC325VP	AFMELC326VP
AFMELC325VA	AFMELC326VA



7" x 10"	10" x 14"
AFMELC639VS	AFMELC625VS
AFMELC639VP	AFMELC625VP
AFMELC639VA	AFMELC625VA



7" x 10"	10" x 14"
AFMELC801VS	AFMELC804VS
AFMELC801VP	AFMELC804VP
AFMELC801VA	AFMELC804VA

**Equipment Machinery & Operations**



Mat'l	7" x 10"	10" x 14"
VS	AFMEQM049VS	AFMEQM050VS
VP	AFMEQM049VP	AFMEQM050VP
VA	AFMEQM049VA	AFMEQM050VA



7" x 10"	10" x 14"
AFMEQM061VS	AFMCRTO16VS
AFMEQM061VP	AFMCRTO16VP
AFMEQM061VA	AFMCRTO16VA



7" x 10"	10" x 14"
AFMECN002VS	AFMECN001VS
AFMECN002VP	AFMECN001VP
AFMECN002VA	AFMECN001VA



7" x 10"	10" x 14"
AFMEQM145VS	AFMEQM147VS
AFMEQM145VP	AFMEQM147VP
AFMEQM145VA	AFMEQM147VA



7" x 10"	10" x 14"
AFMEQM017VS	AFMEQM138VS
AFMEQM017VP	AFMEQM138VP
AFMEQM017VA	AFMEQM138VA



Mat'l	7" x 10"	10" x 14"
VS	AFMEQM087VS	AFMEQM088VS
VP	AFMEQM087VP	AFMEQM088VP
VA	AFMEQM087VA	AFMEQM088VA



7" x 10"	10" x 14"
AFMEQM150VS	AFMEQM152VS
AFMEQM150VP	AFMEQM152VP
AFMEQM150VA	AFMEQM152VA



7" x 10"	10" x 14"
AFMEQM153VS	AFMEQM047VS
AFMEQM153VP	AFMEQM047VP
AFMEQM153VA	AFMEQM047VA



7" x 10"	10" x 14"
AFMEQM095VS	AFMEQM098VS
AFMEQM095VP	AFMEQM098VP
AFMEQM095VA	AFMEQM098VA



7" x 10"	10" x 14"
AFMECR631VS	AFMECR633VS
AFMECR631VP	AFMECR633VP
AFMECR631VA	AFMECR633VA



Mat'l	7" x 10"	10" x 14"
VS	AFMEQC720VS	AFMEQC721VS
VP	AFMEQC720VP	AFMEQC721VP
VA	AFMEQC720VA	AFMEQC721VA



7" x 10"	10" x 14"
AFMECR620VS	AFMECR622VS
AFMECR620VP	AFMECR622VP
AFMECR620VA	AFMECR622VA



7" x 10"	10" x 14"
AFMEQM617VS	AFMECR606VS
AFMEQM617VP	AFMECR606VP
AFMEQM617VA	AFMECR606VA



7" x 10"	10" x 14"
AFMEQM720VS	AFMEQM721VS
AFMEQM720VP	AFMEQM721VP
AFMEQM720VA	AFMEQM721VA



7" x 10"	10" x 14"
AFMECR601VS	AFMECR605VS
AFMECR601VP	AFMECR605VP
AFMECR601VA	AFMECR605VA

**Fire Safety & Emergency**



Mat'l	10" x 7"	14" x 10"
VS	AFMFXG417VS	AFMFXG908VS
VP	AFMFXG417VP	AFMFXG908VP
VA	AFMFXG417VA	AFMFXG908VA



10" x 7"	14" x 10"
AFMFXG419VS	AFMFXG516VS
AFMFXG419VP	AFMFXG516VP
AFMFXG419VA	AFMFXG516VA



7" x 10"	10" x 14"
AFMFXG423VS	AFMFXG518VS
AFMFXG423VP	AFMFXG518VP
AFMFXG423VA	AFMFXG518VA



7" x 10"	10" x 14"
AFMFXG425VS	AFMFXG909VS
AFMFXG425VP	AFMFXG909VP
AFMFXG425VA	AFMFXG909VA



10" x 7"	14" x 10"
AFMFEX541VS	AFMFEX524VS
AFMFEX541VP	AFMFEX524VP
AFMFEX541VA	AFMFEX524VA

Material Code	Material	7" x 10"	10" x 14"
VS	Adhesive Vinyl	\$8.31	\$12.46
VP	Plastic	\$9.06	\$13.53
VA	Aluminum	\$12.95	\$21.51





## First Aid & AED



Mat'l	7" x 10"	10" x 14"
VS	AFMFSD917VS	AFMFSD913VS
VP	AFMFSD917VP	AFMFSD913VP
VA	AFMFSD917VA	AFMFSD913VA



7" x 10"	10" x 14"
AFMFSD928VS	AFMFSD927VS
AFMFSD928VP	AFMFSD927VP
AFMFSD928VA	AFMFSD927VA



7" x 10"	10" x 14"
AFMFSD931VS	AFMFSD929VS
AFMFSD931VP	AFMFSD929VP
AFMFSD931VA	AFMFSD929VA



7" x 10"	10" x 14"
AFMFSD506VS	AFMFSD958VS
AFMFSD506VP	AFMFSD958VP
AFMFSD506VA	AFMFSD958VA



7" x 10"	10" x 14"
AFMFSD959VS	AFMFSD960VS
AFMFSD959VP	AFMFSD960VP
AFMFSD959VA	AFMFSD960VA

## Headers Only



Mat'l	7" x 10"	10" x 14"
VS	AFMRBH607VS	AFMRBH606VS
VP	AFMRBH607VP	AFMRBH606VP
VA	AFMRBH607VA	AFMRBH606VA



7" x 10"	10" x 14"
AFMRBH201VS	AFMRBH205VS
AFMRBH201VP	AFMRBH205VP
AFMRBH201VA	AFMRBH205VA



7" x 10"	10" x 14"
AFMRBH834VS	AFMRBH838VS
AFMRBH834VP	AFMRBH838VP
AFMRBH834VA	AFMRBH838VA



7" x 10"	10" x 14"
AFMRBH965VS	AFMRBH969VS
AFMRBH965VP	AFMRBH969VP
AFMRBH965VA	AFMRBH969VA



7" x 10"	10" x 14"
AFMRBH327VS	AFMRBH331VS
AFMRBH327VP	AFMRBH331VP
AFMRBH327VA	AFMRBH331VA

## Housekeeping & Environmental



Mat'l	7" x 10"	10" x 14"
VS	AFMRST811VS	AFMRST805VS
VP	AFMRST811VP	AFMRST805VP
VA	AFMRST811VA	AFMRST805VA



7" x 10"	10" x 14"
AFMHSHK845VS	AFMHSHK846VS
AFMHSHK845VP	AFMHSHK846VP
AFMHSHK845VA	AFMHSHK846VA



7" x 10"	10" x 14"
AFMHSHK801VS	AFMHSHK838VS
AFMHSHK801VP	AFMHSHK838VP
AFMHSHK801VA	AFMHSHK838VA

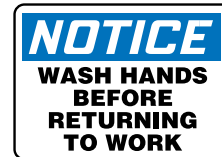

7" x 10"	10" x 14"
AFMRST812VS	AFMRST813VS
AFMRST812VP	AFMRST813VP
AFMRST812VA	AFMRST813VA



7" x 10"	10" x 14"
AFMHSHK939VS	AFMHSHK950VS
AFMHSHK939VP	AFMHSHK950VP
AFMHSHK939VA	AFMHSHK950VA

## Lockout/Tagout



Mat'l	7" x 10"	10" x 14"
VS	AFMLKT106VS	AFMLKT015VS
VP	AFMLKT106VP	AFMLKT015VP
VA	AFMLKT106VA	AFMLKT015VA



7" x 10"	10" x 14"
AFMLKT007VS	AFMLKT014VS
AFMLKT007VP	AFMLKT014VP
AFMLKT007VA	AFMLKT014VA



7" x 10"	10" x 14"
AFMLKT021VS	AFMLKT016VS
AFMLKT021VP	AFMLKT016VP
AFMLKT021VA	AFMLKT016VA



7" x 10"	10" x 14"
AFMLKT005VS	AFMLKT003VS
AFMLKT005VP	AFMLKT003VP
AFMLKT005VA	AFMLKT003VA



7" x 10"	10" x 14"
AFMLKT611VS	AFMLKT615VS
AFMLKT611VP	AFMLKT615VP
AFMLKT611VA	AFMLKT615VA

## Personal Protective Equipment



Mat'l	7" x 10"	10" x 14"
VS	AFMPPE164VS	AFMPPE108VS
VP	AFMPPE164VP	AFMPPE108VP
VA	AFMPPE164VA	AFMPPE108VA



7" x 10"	10" x 14"
AFMPPE011VS	AFMPPE010VS
AFMPPE011VP	AFMPPE010VP
AFMPPE011VA	AFMPPE010VA



7" x 10"	10" x 14"
AFMFPR104VS	AFMFPR105VS
AFMFPR104VP	AFMFPR105VP
AFMFPR104VA	AFMFPR105VA



7" x 10"	10" x 14"
AFMPPA004VS	AFMPPA005VS
AFMPPA004VP	AFMPPA005VP
AFMPPA004VA	AFMPPA005VA



7" x 10"	10" x 14"
AFMPPE153VS	AFMPPA036VS
AFMPPE153VP	AFMPPA036VP
AFMPPE153VA	AFMPPA036VA

Material Code	Material	7" x 10"	10" x 14"
VS	Adhesive Vinyl	\$8.31	\$12.46
VP	Plastic	\$9.06	\$13.53
VA	Aluminum	\$12.95	\$21.51



**Personal Protective Equipment continued**



Mat'l	7" x 10"	10" x 14"
VS	AFMPPE219VS	AFMPPE218VS
VP	AFMPPE219VP	AFMPPE218VP
VA	AFMPPE219VA	AFMPPE218VA



7" x 10"	10" x 14"
AFMPPE018VS	AFMPPE127VS
AFMPPE018VP	AFMPPE127VP
AFMPPE018VA	AFMPPE127VA



7" x 10"	10" x 14"
AFMPPA001VS	AFMPPA002VS
AFMPPA001VP	AFMPPA002VP
AFMPPA001VA	AFMPPA002VA



7" x 10"	10" x 14"
AFMPPE436VS	AFMPPA608VS
AFMPPE436VP	AFMPPA608VP
AFMPPE436VA	AFMPPA608VA



7" x 10"	10" x 14"
AFMPPA605VS	AFMPPA606VS
AFMPPA605VP	AFMPPA606VP
AFMPPA605VA	AFMPPA606VA



Mat'l	7" x 10"	10" x 14"
VS	AFMPPE795VS	AFMPPE748VS
VP	AFMPPE795VP	AFMPPE748VP
VA	AFMPPE795VA	AFMPPE748VA



7" x 10"	10" x 14"
AFMPPE441VS	AFMPPE722VS
AFMPPE441VP	AFMPPE722VP
AFMPPE441VA	AFMPPE722VA



7" x 10"	10" x 14"
AFMPPE776VS	AFMPPA620VS
AFMPPE776VP	AFMPPA620VP
AFMPPE776VA	AFMPPA620VA



7" x 10"	10" x 14"
AFMPPE675VS	AFMPPE676VS
AFMPPE675VP	AFMPPE676VP
AFMPPE675VA	AFMPPE676VA



7" x 10"	10" x 14"
AFMPPE438VS	AFMPPE440VS
AFMPPE438VP	AFMPPE440VP
AFMPPE438VA	AFMPPE440VA



Mat'l	7" x 10"	10" x 14"
VS	AFMPPE406VS	AFMPPE736VS
VP	AFMPPE406VP	AFMPPE736VP
VA	AFMPPE406VA	AFMPPE736VA



7" x 10"	10" x 14"
AFMPFR602VS	AFMPFR601VS
AFMPFR602VP	AFMPFR601VP
AFMPFR602VA	AFMPFR601VA



7" x 10"	10" x 14"
AFMPPE855VS	AFMPPA808VS
AFMPPE855VP	AFMPPA808VP
AFMPPE855VA	AFMPPA808VA



7" x 10"	10" x 14"
AFMPPE849VS	AFMPPA818VS
AFMPPE849VP	AFMPPA818VP
AFMPPE849VA	AFMPPA818VA



7" x 10"	10" x 14"
AFMPPE930VS	AFMPPE913VS
AFMPPE930VP	AFMPPE913VP
AFMPPE930VA	AFMPPE913VA

**Radiation, Laser & Radio Frequency**



Mat'l	7" x 10"	10" x 14"
VS	AFMRAD021VS	AFMRAD022VS
VP	AFMRAD021VP	AFMRAD022VP
VA	AFMRAD021VA	AFMRAD022VA



7" x 10"	10" x 14"
AFMRAD639VS	AFMRAD602VS
AFMRAD639VP	AFMRAD602VP
AFMRAD639VA	AFMRAD602VA



7" x 10"	10" x 14"
AFMRFO824VS	AFMRFO825VS
AFMRFO824VP	AFMRFO825VP
AFMRFO824VA	AFMRFO825VA



7" x 10"	10" x 14"
AFMRAD501VS	AFMRAD500VS
AFMRAD501VP	AFMRAD500VP
AFMRAD501VA	AFMRAD500VA



7" x 10"	10" x 14"
AFMRAD503VS	AFMRAD502VS
AFMRAD503VP	AFMRAD502VP
AFMRAD503VA	AFMRAD502VA

**Safety Incentive/Slips, Trips & Falls**



Mat'l	7" x 10"	10" x 14"
VS	AFMSTF647VS	AFMSTF649VS
VP	AFMSTF647VP	AFMSTF649VP
VA	AFMSTF647VA	AFMSTF649VA



7" x 10"	10" x 14"
AFMSTF640VS	AFMSTF642VS
AFMSTF640VP	AFMSTF642VP
AFMSTF640VA	AFMSTF642VA



7" x 10"	10" x 14"
AFMSTF646VS	AFMSTF648VS
AFMSTF646VP	AFMSTF648VP
AFMSTF646VA	AFMSTF648VA



7" x 10"	10" x 14"
AFMSTF659VS	AFMSTF660VS
AFMSTF659VP	AFMSTF660VP
AFMSTF659VA	AFMSTF660VA



7" x 10"	10" x 14"
AFMSTF645VS	AFMSTF661VS
AFMSTF645VP	AFMSTF661VP
AFMSTF645VA	AFMSTF661VA



Mat'l	7" x 10"	10" x 14"
VS	AFMGNF984VS	AFMGSH904VS
VP	AFMGNF984VP	AFMGSH904VP
VA	AFMGNF984VA	AFMGSH904VA



7" x 10"	10" x 14"
AFMGNF980VS	AFMGNF996VS
AFMGNF980VP	AFMGNF996VP
AFMGNF980VA	AFMGNF996VA



7" x 10"	10" x 14"
AFMGNF956VS	AFMGNF940VS
AFMGNF956VP	AFMGNF940VP
AFMGNF956VA	AFMGNF940VA



7" x 10"	10" x 14"
AFMGNF983VS	AFMGNF999VS
AFMGNF983VP	AFMGNF999VP
AFMGNF983VA	AFMGNF999VA



7" x 10"	10" x 14"
AFMGNF501VS	AFMGNF500VS
AFMGNF501VP	AFMGNF500VP
AFMGNF501VA	AFMGNF500VA

Material Code	Material	7" x 10"	10" x 14"
VS	Adhesive Vinyl	\$8.31	\$12.46
VP	Plastic	\$9.06	\$13.53
VA	Aluminum	\$12.95	\$21.51



## Smoking Control



Mat'l	7" x 10"	10" x 14"
VS	AFMSMK132VS	AFMSMK133VS
VP	AFMSMK132VP	AFMSMK133VP
VA	AFMSMK132VA	AFMSMK133VA



7" x 10"	10" x 14"
AFMSMK120VS	AFMSMK050VS
AFMSMK120VP	AFMSMK050VP
AFMSMK120VA	AFMSMK050VA



7" x 10"	10" x 14"
AFMSMK135VS	AFMSMK136VS
AFMSMK135VP	AFMSMK136VP
AFMSMK135VA	AFMSMK136VA



7" x 10"	10" x 14"
AFMSMK404VS	AFMSMK403VS
AFMSMK404VP	AFMSMK403VP
AFMSMK404VA	AFMSMK403VA



7" x 10"	10" x 14"
AFMSMK575VS	AFMSMK545VS
AFMSMK575VP	AFMSMK545VP
AFMSMK575VA	AFMSMK545VA



Mat'l	7" x 10"	10" x 14"
VS	AFMSMK427VS	AFMSMK948VS
VP	AFMSMK427VP	AFMSMK948VP
VA	AFMSMK427VA	AFMSMK948VA



7" x 10"	10" x 14"
AFMSMK432VS	AMSMG510VS
AFMSMK432VP	AMSMG510VP
AFMSMK432VA	AMSMG510VA



7" x 10"	10" x 14"
AFMSMG501VS	AFMSMG502VS
AFMSMG501VP	AFMSMG502VP
AFMSMG501VA	AFMSMG502VA



7" x 10"	10" x 14"
AFMSMK413VS	AFMSMK412VS
AFMSMK413VP	AFMSMK412VP
AFMSMK413VA	AFMSMK412VA



7" x 10"	10" x 14"
AFMSMK850VS	AFMSMK849VS
AFMSMK850VP	AFMSMK849VP
AFMSMK850VA	AFMSMK849VA

## Traffic - Industrial



7" x 10"	10" x 14"
AFMTKC302VS	AFMVHR331VS
AFMTKC302VP	AFMVHR331VP
AFMTKC302VA	AFMVHR331VA



7" x 10"	10" x 14"
AFMVHR680VS	AFMVHR687VS
AFMVHR680VP	AFMVHR687VP
AFMVHR680VA	AFMVHR687VA



7" x 10"	10" x 14"
AFMVHR631VS	AFMVHR633VS
AFMVHR631VP	AFMVHR633VP
AFMVHR631VA	AFMVHR633VA



7" x 10"	10" x 14"
AFMVHR846VS	AFMVHR847VS
AFMVHR846VP	AFMVHR847VP
AFMVHR846VA	AFMVHR847VA



7" x 10"	10" x 14"
AFMVHR830VS	AFMVHR842VS
AFMVHR830VP	AFMVHR842VP
AFMVHR830VA	AFMVHR842VA



## ANSI-ISO Safety Signs

ISO 7010 graphical symbol is combined onto ANSI Z535 signs. This provides universal understanding of the safety message, comprehension by more workers of different backgrounds. ANSI Z535 format signs are inclusive in the OSHA regulations.



Mat'l	10" x 14"
VS	AFMRSP106VS
VP	AFMRSP106VP
VA	AFMRSP106VA



10" x 14"
AFMRHL106VS
AFMRHL106VP
AFMRHL106VA



10" x 14"
AFMVHR021VS
AFMVHR021VP
AFMVHR021VA



10" x 14"
AFMRQM103VS
AFMRQM103VP
AFMRQM103VA



10" x 14"
AFMRMK008VS
AFMRMK008VP
AFMRMK008VA

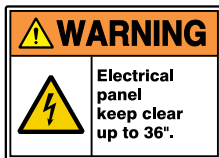

Mat'l	10" x 14"
VS	AFMRLC307VS
VP	AFMRLC307VP
VA	AFMRLC307VA



10" x 14"
AFMRQM309VS
AFMRQM309VP
AFMRQM309VA



10" x 14"
AFMRPE643VS
AFMRPE643VP
AFMRPE643VA



10" x 14"
AFMRPE646VS
AFMRPE646VP
AFMRPE646VA



10" x 14"
AFMRPE644VS
AFMRPE644VP
AFMRPE644VA

Material Code	Material	7" x 10"	10" x 14"
VS	Adhesive Vinyl	\$8.31	\$12.46
VP	Plastic	\$9.06	\$13.53
VA	Aluminum	\$12.95	\$21.51





Keep Your English & Spanish Speaking Employees Safe.

Wherever the workforce has a mix of English and Spanish speaking employees, it is common for many manufacturing, plant, and warehouse locations to use Bilingual Spanish signs, labels, and tags with the same text repeated in both languages.

Bilingual Spanish Signs are designed to help convey the same proper direction and safety information to Spanish-speaking workers, as English signs.



Z535.2 "...In certain areas of the country where other languages are used, consideration should be given to providing messages in those languages..."

## Admittance & Exit



Mat'l	14" x 10"	20" x 14"
VS	AFSBMADM006VS	AFSBMADM108VS
VP	AFSBMADM006VP	AFSBMADM108VP
VA	AFSBMADM006VA	AFSBMADM108VA



14" x 10"	20" x 14"
AFSBMADM139VS	AFSBMADM129VS
AFSBMADM139VP	AFSBMADM129VP
AFSBMADM139VA	AFSBMADM129VA



14" x 10"	20" x 14"
AFSBMADM304VS	AFSBMATR302VS
AFSBMADM304VP	AFSBMATR302VP
AFSBMADM304VA	AFSBMATR302VA



14" x 10"	20" x 14"
AFSBMADC804VS	AFSBMADM403VS
AFSBMADC804VP	AFSBMADM403VP
AFSBMADC804VA	AFSBMADM403VA



14" x 10"	20" x 14"
AFSBMATR806VS	AFSBMATR804VS
AFSBMATR806VP	AFSBMATR804VP
AFSBMATR806VA	AFSBMATR804VA

## Chemical & Hazmat



Mat'l	14" x 10"	20" x 14"
VS	AFSBMCHL192VS	AFSBMCHL155VS
VP	AFSBMCHL192VP	AFSBMCHL155VP
VA	AFSBMCHL192VA	AFSBMCHL155VA



14" x 10"	20" x 14"
AFSBMCHL226VS	AFSBMCHL211VS
AFSBMCHL226VP	AFSBMCHL211VP
AFSBMCHL226VA	AFSBMCHL211VA



14" x 10"	20" x 14"
AFSBMCHG046VS	AFSBMCHL211VS
AFSBMCHG046VP	AFSBMCHL211VP
AFSBMCHG046VA	AFSBMCHL211VA



14" x 10"	20" x 14"
AFSBMCHL092VS	AFSBMCHL267VS
AFSBMCHL092VP	AFSBMCHL267VP
AFSBMCHL092VA	AFSBMCHL267VA



14" x 10"	20" x 14"
AFSBMCAW109VS	AFSBMCAW116VS
AFSBMCAW109VP	AFSBMCAW116VP
AFSBMCAW109VA	AFSBMCAW116VA

## Confined Space & Electrical



Mat'l	14" x 10"	20" x 14"
VS	AFSBMCSP141VS	AFSBMCSP011VS
VP	AFSBMCSP141VP	AFSBMCSP011VP
VA	AFSBMCSP141VA	AFSBMCSP011VA



14" x 10"	20" x 14"
AFSBMCSP230VS	AFSBMCSP040VS
AFSBMCSP230VP	AFSBMCSP040VP
AFSBMCSP230VA	AFSBMCSP040VA



14" x 10"	20" x 14"
AFSBMCSP134VS	AFSBMCSP143VS
AFSBMCSP134VP	AFSBMCSP143VP
AFSBMCSP134VA	AFSBMCSP143VA



14" x 10"	20" x 14"
AFSBMELC002VS	AFSBMELC202VS
AFSBMELC002VP	AFSBMELC202VP
AFSBMELC002VA	AFSBMELC202VA



14" x 10"	20" x 14"
AFSBMELC114VS	AFSBMELC116VS
AFSBMELC114VP	AFSBMELC116VP
AFSBMELC114VA	AFSBMELC116VA

## Personal Protection



Mat'l	14" x 10"	20" x 14"
VS	AFSBMPPA107VS	AFSMG695Y3VS
VP	AFSBMPPA107VP	AFSMG695Y3VP
VA	AFSBMPPA107VA	AFSMG695Y3VA



14" x 10"	20" x 14"
AFSBMPPA105VS	AFSBMPPA109VS
AFSBMPPA105VP	AFSBMPPA109VP
AFSBMPPA105VA	AFSBMPPA109VA



14" x 10"	20" x 14"
AFSBMPPA027VS	AFSBMPPA106VS
AFSBMPPA027VP	AFSBMPPA106VP
AFSBMPPA027VA	AFSBMPPA106VA



14" x 10"	20" x 14"
AFSBMCHL610VS	AFPPC078Y3VS
AFSBMCHL610VP	AFPPC078Y3VP
AFSBMCHL610VA	AFPPC078Y3VA



14" x 10"	20" x 14"
AFSBMPPE682VS	AFSBMPPA661VS
AFSBMPPE682VP	AFSBMPPA661VP
AFSBMPPE682VA	AFSBMPPA661VA

Material Code	Material	14" x 10"	20" x 14"
VS	Adhesive Vinyl	\$12.46	\$22.02
VP	Plastic	\$13.53	\$24.62
VA	Aluminum	\$21.51	\$40.97



- No set-up fees
- Any print colors you choose, right to the edges
- High-definition, full-color graphics at no additional charge
- Any lettering or font to fit your design
- Comprehensive, free design support

## How to Order Custom Signs

### Step 1: Develop Message

Your sign message should be easily understood. Include graphics, pictorials, logos or full-color images. Sketch out your ideas, and we'll take it from there.

### Step 2: Select Material

Our comprehensive selection of custom sign materials is built for flexibility and durability for any environmental condition. Think about where you will install your sign when choosing a material.

### Step 3: Size & Placement

A sign not seen is an opportunity lost. Keep in mind your intended application and placement when determining sign size.

### Step 4: Send Us Your Order

Call, e-mail or fax us to place your order. Be sure to provide any high resolution graphics (images, logos, etc.) along with your sketch or description.



Personalized with Corporate Identity

Full-Color Photographic Quality Images

Impactful Motivational Message

Unique Eye-Catching Design Layout

## Accu-Shield™:

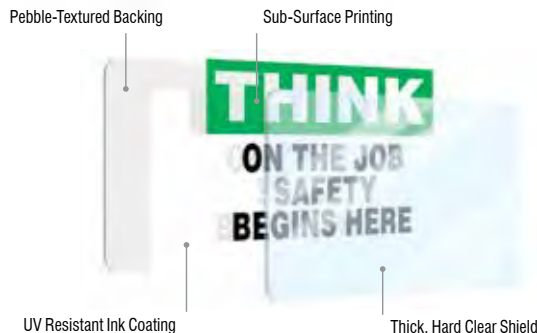

## AccuShield™

Highest performance sign with superior construction for extreme conditions – outstanding UV protection, high-impact strength, tough under harsh conditions such as chemicals, corrosion, and abrasions, and nearly indestructible to vandalism. Reverse-printed image on the underside of the thick face and further protected underneath. Rugged appearance with a thick-edge design and pebble-textured backside.

- .152" or .214" thick specially-formulated polycarbonate and poly bonded back
- Durability warranty to 15 years
- 1/4" mounting holes with rounded corners

### .152" Thick – Ideal for Small to Medium Signs

Size	Part #	1	6 - 9	10 - 24	25 - 49	50+
7" x 10"	AFAC710	\$34.53	\$25.39	\$21.11	\$16.74	\$13.88
10" x 14"	AFAC1014	\$45.28	\$36.13	\$31.96	\$27.82	\$25.88
14" x 20"	AFAC1420	\$73.82	\$61.79	\$57.54	\$53.17	\$48.25
Other Sizes & Shapes	AFAC555	Call for quote				

### .214" Thick – Ideal for Medium to Large Signs

Size	Part #	1	6 - 9	10 - 24	25 - 49	50+
12" x 18"	AFAS1218	\$57.56	\$43.16	\$41.36	\$39.57	\$34.60
14" x 20"	AFAS1420	\$78.28	\$65.48	\$60.99	\$56.61	\$51.16
18" x 24"	AFAS1824	\$109.93	\$96.74	\$87.76	\$81.53	\$75.16
Other Sizes & Shapes	AFAS555	Call for quote				

## Adhesive Vinyl:



Self stick is for indoor or sheltered areas. Adhere to most flat, clean, dry surfaces. Ideal for basic identification purposes or short term outdoor applications.

- Flexible 4-mil thick vinyl with acrylic adhesive
- Non-glare printed surface
- Impact resistant
- Moisture resistant



Size	Part #	1	6 - 9	10 - 24	25 - 49	50+
7" x 10"	AFVS710	\$22.65	\$14.62	\$9.05	\$7.05	\$3.45
10" x 14"	AFVS1014	\$26.79	\$18.33	\$12.60	\$10.57	\$6.31
14" x 20"	AFVS1420	\$42.36	\$29.96	\$21.71	\$18.65	\$11.93
Other Sizes & Shapes	AFVS555	Call for quote				

## Adhesive Dura-Vinyl™:



Dual-layered vinyl that outperforms standard vinyl. Printed image is protected by a high-gloss UV protective coating to prevent fading for outdoor use.

- Flexible 6-mil thick poly-composite
- Durability warranty to 5 years
- Abrasion, humidity, chemical, and solvent resistant
- Adheres to smooth, curved and irregular surfaces



Size	Part #	1	6 - 9	10 - 24	25 - 49	50+
7" x 10"	AFXV710	\$25.56	\$16.74	\$10.68	\$8.11	\$4.48
10" x 14"	AFXV1014	\$29.91	\$21.08	\$15.00	\$12.13	\$8.16
14" x 20"	AFXV1420	\$46.62	\$33.96	\$25.39	\$21.88	\$15.11
Other Sizes & Shapes	AFXV555	Call for quote				

## Plastic:



Semi-flexible thick plastic for standard, medium-duty use. Use long-term indoor and sheltered outdoor locations – or temporary outdoor exposure, such as construction sites.

- .055" thick polyethylene plastic
- Non-glare finish
- 3/16" mounting holes with rounded corners
- Made from 50% recycled material



Size	Part #	1	6 - 9	10 - 24	25 - 49	50+
7" x 10"	AFVP710	\$24.22	\$15.85	\$10.13	\$7.71	\$4.28
10" x 14"	AFVP1014	\$28.13	\$19.79	\$14.13	\$11.48	\$7.73
14" x 20"	AFVP1420	\$46.31	\$33.73	\$25.25	\$20.85	\$15.00
Other Sizes & Shapes	AFVP555	Call for quote				

## Dura-Plastic™:



Polycarbonate plastic offers high impact resistance and durability for outdoor applications and harsh environments. Printed image is protected by a high-gloss UV protective coating.

- .060" thick polycarbonate
- Resistant to abrasion, humidity, and chemicals
- Durability warranty to 7 years
- 3/16" mounting holes with rounded corners



Size	Part #	1	6 - 9	10 - 24	25 - 49	50+
7" x 10"	AFXD710	\$30.79	\$22.53	\$16.99	\$13.48	\$10.37
10" x 14"	AFXD1014	\$39.85	\$31.62	\$26.08	\$22.42	\$18.25
14" x 20"	AFXD1420	\$73.16	\$59.93	\$50.91	\$41.80	\$36.85
Other Sizes & Shapes	AFXD555	Call for quote				

Don't see what you're looking for? Additional materials and sizes are available. Call us for details.



Mailing Address: P.O. Box 1025 • Deer Park, TX 77536



## Aluminum:

5 YEARS GUARANTEED



AVAILABLE IN ANY SHAPE

Provides the strength of metal, yet does not rust. Printed image is protected by, high-gloss UV protective coating to resist fading. Ideal choice for indoor and outdoor use where a metal sign is required.

- .040" thick aluminum ideal for small to medium signs
- Withstands washdowns, harsh environments and is abrasion, chemical, and impact resistant.
- Durability warranty to 5 years
- 3/16" mounting holes with rounded corners

Size	Part #	1	6 - 9	10 - 24	25 - 49	50+
7" x 10"	AFVA710	\$24.33	\$17.85	\$13.36	\$10.99	\$8.19
10" x 14"	AFVA1014	\$31.56	\$25.08	\$20.65	\$18.22	\$14.51
14" x 20"	AFVA1420	\$55.37	\$45.33	\$38.57	\$34.71	\$27.88
Other Sizes & Shapes	AFVA555	Call for quote				

## Aluma-Lite™:

10 YEARS GUARANTEED



AVAILABLE IN ANY SHAPE

High strength, yet lightweight composite aluminum sign. 40% lighter than same thick solid aluminum, yet the same durability, stiffness and rigidity. Protected by high-gloss UV protective coating to resist fading and abrasions.

- .118" thick - aluminum sheets bonded to both sides of thermoplastic core
- Extremely durable for tough indoor and outdoor conditions from high impacts to vandalism
- Durability warranty to 10 years
- 1/4" mounting holes with rounded corners

Size	Part #	1	6 - 9	10 - 24	25 - 49	50+
7" x 10"	AFXL710	\$31.85	\$23.36	\$17.51	\$14.19	\$13.25
10" x 14"	AFXL1014	\$39.96	\$31.73	\$27.79	\$23.65	\$22.51
14" x 20"	AFXL1420	\$69.45	\$58.52	\$56.25	\$43.97	\$42.51
Other Sizes & Shapes	AFXL555	Call for quote				

## Stainless Steel – Full Color:

10 YEARS GUARANTEED



AVAILABLE IN ANY SHAPE

### Stainless Steel

Signs offer maximum legend recognition with a distinctive natural stainless steel edge. Signs are surface printed, and the printed image is protected by a UV protective coating that offers protection from graffiti, chemicals, moisture, scratches and dirt. Designed to withstand tough, abusive environments indoors and in ambient temperature outdoor environments. Stainless Steel signs are ideal for withstanding exposures from chemical, textile, petroleum, maritime, and food industries.

- 20-gauge (.0375" thick), Type 304 Stainless Steel
- Withstands wash-downs to meet tough cleanliness demands
- Service temperature range up to 200°F.
- 3/16" mounting holes, Rounded corners

Size	Part #	1	6 - 9	10 - 24	25 - 49	50+
3 1/2" x 5"	AFSN35	\$30.59	\$22.19	\$16.74	\$10.40	\$8.54
5" x 7"	AFSN57	\$31.53	\$22.88	\$17.28	\$12.08	\$9.88
7" x 10"	AFSN710	\$37.65	\$27.53	\$20.68	\$15.80	\$12.96
9" x 12"	AFSN912	\$43.31	\$33.19	\$26.39	\$21.56	\$17.68
10" x 14"	AFSN1014	\$48.82	\$38.79	\$31.93	\$27.05	\$22.19
Other Size & Shape	AFSN555	Call for quote				

Don't see what you're looking for? Additional materials and sizes are available. Call us for details.

Personalize in a maximum way! Big, bold characters are easy to read from thousands of feet away.

**Diamond Plate Aluminum:**

Metalized, silver diamond plate pattern provides a rugged, 3D look on .080" thick, Max-Duty Aluminum. The realistic diamond plate appearance is actually a smooth protective surface for industrial style use. The diamond surface, high-strength aluminum withstands tough conditions and does not corrode, rust, or weigh heavy like steel.

- Diamond-plate appearance on .080" thick, Max-Duty Aluminum
- Resists chemical splashes, pressure washes, scrapes, and impacts
- Mounting holes available upon request

Size	Part #	1	6 - 9	10 - 24	25+
24" x 24" (2-ft. x 2-ft.)	AFXDA202	\$111.02	\$98.05	\$89.31	\$83.65
24" x 36" (2-ft. x 3-ft.)	AFXDA203	\$160.37	\$141.11	\$128.62	\$119.48
36" x 36" (3-ft. x 3-ft.)	AFXDA303	\$275.88	\$248.80	\$212.94	\$185.17
36" x 48" (3-ft. x 4-ft.)	AFXDA304	\$299.96	\$269.00	\$228.02	\$196.25
36" x 60" (3-ft. x 5-ft.)	AFXDA305	\$382.05	\$354.02	\$317.14	Call
48" x 48" (4-ft. x 4-ft.)	AFXDA404	\$382.05	\$354.02	\$317.14	Call
48" x 72" (4-ft. x 6-ft.)	AFXDA406	\$442.57	\$414.85	\$378.57	Call
48" x 96" (4-ft. x 8-ft.)	AFXDA408	\$553.20	\$521.62	\$497.36	Call
Other Size & Shape	AFXDA555	Call for quote			

**Ultra-Aluma-Lite™:**

Ultra-lightweight properties combine with high-strength, rugged, engineering to make this composite aluminum .236" thick sign extremely durable – enabling it to withstand tough conditions both indoors and out. Material is 40% lighter than solid aluminum, yet maintains the same durability, stiffness, and rigidity.

- Resists impacts, flexing, vandalism, corrosion, chemicals, abrasions, and more
- Printed surface protected by UV protective coating film
- Service temperature range: -58° to 175°F

**Ultra Aluma-Lite™ – .236" Thick**

Size	Part #	1	6 - 9	10 - 24	25+
24" x 24" (2-ft. x 2-ft.)	AFXAT202	\$167.11	\$138.76	\$132.45	\$129.11
24" x 36" (2-ft. x 3-ft.)	AFXAT203	\$241.33	\$198.93	\$189.88	\$185.05
36" x 36" (3-ft. x 3-ft.)	AFXAT303	\$415.13	\$331.57	\$316.51	\$308.39
36" x 48" (3-ft. x 4-ft.)	AFXAT304	\$451.40	\$356.11	\$339.88	\$331.25
36" x 60" (3-ft. x 5-ft.)	AFXAT305	\$574.88	\$487.65	\$465.45	\$453.59
48" x 48" (4-ft. x 4-ft.)	AFXAT404	\$574.88	\$487.65	\$465.45	\$453.59
48" x 72" (4-ft. x 6-ft.)	AFXAT406	\$748.68	\$654.51	\$624.71	\$608.79
48" x 96" (4-ft. x 8-ft.)	AFXAT408	\$808.42	\$689.88	\$658.48	\$641.73
Other Size & Shape	AFXAT555	Call for quote			

**Heavy-Duty EGP Reflective Aluminum:**

Engineer-Grade Prismatic signs provide added visibility in low-light conditions. Micro-prismatic retroreflective sheeting is recommended for commercial sign applications. Available in an assortment of colors; contact us for details.

- Heavy-duty, .080" aluminum signs will not rust
- UV-resistant inks prevent fading during long-term outdoor use
- Mounting holes available upon request

Size	Part #	1	6 - 9	10 - 24	25+
24" x 24" (2-ft. x 2-ft.)	AFXRA202	\$123.96	\$109.45	\$99.22	\$85.51
24" x 36" (2-ft. x 3-ft.)	AFXRA203	\$179.05	\$157.53	\$142.93	\$110.60
36" x 36" (3-ft. x 3-ft.)	AFXRA303	\$312.42	\$280.39	\$237.71	\$149.08
36" x 48" (3-ft. x 4-ft.)	AFXRA304	\$339.68	\$303.19	\$254.56	\$196.57
36" x 60" (3-ft. x 5-ft.)	AFXRA305	\$426.56	\$395.25	\$352.37	\$264.94
48" x 48" (4-ft. x 4-ft.)	AFXRA404	\$426.56	\$395.25	\$352.37	\$264.94
48" x 72" (4-ft. x 6-ft.)	AFXRA406	\$494.11	\$163.13	\$420.65	\$366.25
48" x 96" (4-ft. x 8-ft.)	AFXRA408	\$617.65	\$578.91	\$528.76	\$457.79
Other Size & Shape	AFXRA555	Call for quote			



**TRUCK SHIPMENTS (LTL - Less than Truckload)** We are committed to getting items only transportable by truck to you in excellent condition, and in a timely manner. We know that your business depends on speed and convenience. To assist in providing advance notice on items that **MUST** ship by truck, we have identified those items with a truck icon throughout this catalog. If you do not have a preferred LTL carrier, we will help determine the best carrier for your order. On occasion, large quantity orders may be more cost effective to ship via LTL carrier; in these instances, you will be notified prior to shipment. Truck shipments do not qualify for any special shipping promotions.

- .10" thick high-impact plastic
- 3D signs, projecting 45° from the wall, provide optimum viewing from front and sides
- 90D signs, projecting 90° from the wall, are viewed from either side
- Includes mounting holes and hardware
- Price per Each



 3D AFPSP609	 90D AFPSP708	 3D AFPSP861	 90D AFPSP972	 3D AFPSP608	 90D AFPSP710	 3D AFPSP317	 90D AFPSP428	 3D AFPSP808	 90D AFPSP919	 3D AFPSP601	 90D AFPSP702
 3D AFPSP863	 90D AFPSP974	 3D AFPSP620	 90D AFPSP730	 3D AFPSP611	 90D AFPSP722	 3D AFPSP618	 90D AFPSP729	 3D AFPSP348	 90D AFPSP459	 3D AFPSP613	 90D AFPSP724
 3D AFPSP605	 90D AFPSP706	 3D AFPSP619	 90D AFPSP723	 3D AFPSP138	 90D AFPSP249	 3D AFPSP370	 90D AFPSP481	 3D AFPSP603	 90D AFPSP704	 3D AFPSP141	 90D AFPSP252
 3D AFPSP352	 90D AFPSP463	 3D AFPSP381	 90D AFPSP492	 3D AFPSP379	 90D AFPSP487	 3D AFPSP615	 90D AFPSP726	 3D AFPSP146	 90D AFPSP257	 3D AFPSP354	 90D AFPSP465

Panel Size	Overall Size	Standard 3D	 3D	Standard 90D	 90D
6" x 5"	6" x 8-1/2" x 4"	\$14.64	\$19.91	—	—
8" x 8"	8" x 8" x 1-1/2"	—	—	\$15.82	\$21.55



### Evacuation Map Holders

In an emergency, see where to go to get out safely.

- Map Holder is constructed of .040" clear polycarbonate face with standard (non-glow) or photoluminescent (glow) plastic back
- Accommodates clear transparency film insert (sold separately)
- Simply print map onto clear insert from your computer, and slide into holder
- Glow-in-the-dark background option is visible when the lights go out and appears white in regular light conditions
- Border is printed with clear bold letters – with the glow area for the letters – to identify the evacuation map in light and dark
- Includes adhesive foam strips for mounting



#### HOLDERS

Style	Fits Insert Size	Overall Size	Part #	Price / Each
Standard	8-1/2" x 11"	12" x 11-1/2"	AFDTA235	\$52.96
Standard	11" x 17"	15-1/2" x 17-1/2"	AFDTA237	\$62.11
Glow	8-1/2" x 11"	12" x 11-1/2"	AFDTA202	\$71.88
Glow	11" x 17"	15-1/2" x 17-1/2"	AFDTA204	\$99.68

#### CLEAR INSERTS

Size	Part #	Price / Pkg. of 2
8-1/2" x 11"	AFDTA213	\$9.52
11" x 17"	AFDTA215	\$16.03

### Severe Weather Map Holders

Plan and display where to go for safety.

- Simply print map from your computer and slide into holder, easily change and update
- Constructed of .040" polycarbonate
- Includes adhesive foam strips for mounting
- Glow style holder has photoluminescent back to glow through transparency film insert (sold separately)
- Measures 12" x 11-1/2"
- Holds 8-1/2" x 11" insert



#### HOLDERS

Style	Part #	Price / Each
Standard	AFDTA303	\$52.96
Glow	AFDTA306	\$71.88

#### CLEAR INSERTS

Size	Part #	Price / Pkg. of 2
8-1/2" x 11"	AFDTA213	\$9.52

### Hanger Tags

- Slip Hanger Tags onto any door knob handle or hook
- 9"H x 4"W, 15-mil RP-Plastic tag
- Message repeated both sides
- Available in packages of 10

Style	Price / Pkg. of 10
Standard	\$28.53
Glow	\$32.91



AFTAD838

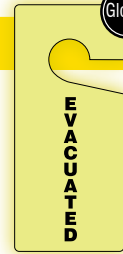

AFTAD201

### Lumi-Glow™ Emergency & Fire Signs

Glow



Mat'l  
GF 10" x 14" AFMLEX578GF  
GP 10" x 14" AFMLEX578GP



10" x 14" AFMLEX569GF  
10" x 14" AFMLEX569GP



10" x 14" AFMADC533GF  
10" x 14" AFMADC533GP



10" x 14" AFMADC535GF  
10" x 14" AFMADC535GP



Mat'l  
GF 10" x 14" AFMADC501GF  
GP 10" x 14" AFMADC501GP



10" x 14" AFMEXT502GF  
10" x 14" AFMEXT502GP



10" x 14" AFMLFX541GF  
10" x 14" AFMLFX541GP



10" x 14" AFMLFX578GF  
10" x 14" AFMLFX578GP



18" x 4" AFMLFX509GF  
18" x 4" AFMLFX509GP



18" x 4" AFMLFX551GF  
18" x 4" AFMLFX551GP

Material Code	Material	10" x 14"	18" x 4"
GF	Lumi-Glow™ Flex	\$28.73	\$16.35
GP	Lumi-Glow™ Plastic	\$37.57	\$24.17

Don't see what you're looking for?  
Additional legends and sizes are available. Call us for details.

### Outdoor Muster Point Signs

Constructed with a micro-prismatic retroreflective sheeting provides added visibility in low-light conditions. Meets A STM D 4956 Type I.

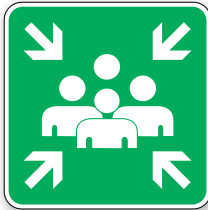

24" x 24"  
30" x 30"

AFFRR918RA  
AFFRR919RA

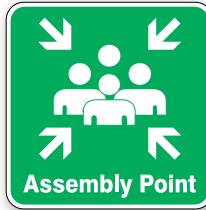

24" x 24"  
30" x 30"

AFFRR922RA  
AFFRR923RA

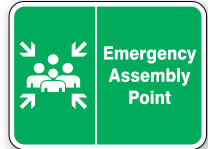

18" x 24"  
24" x 30"

AFFRR928RA  
AFFRR929RA



18" x 24"  
24" x 30"

AFFRR916RA  
AFFRR917RA



18" x 24"  
24" x 30"

AFFRR912RA  
AFFRR913RA



18" x 24"  
24" x 30"

AFFRR910RA  
AFFRR911RA

#### ENGINEER-GRADE PRISMATIC Size Price / Each

18" x 24"	\$75.80
24" x 30"	\$121.51
24" x 24"	\$100.95
30" x 30"	\$139.66

#### JOB-SITE BOX (In photo above)

Item	Part #	Price / Each
Job-Site Box	AFZRS360	\$199.54
11" Nylon Tie	AFHTT109	\$0.53

### Indoor Glow Muster Point Signs



Mat'l 12" x 12"  
GF AFMFEX935GF  
GP AFMFEX935GP



18" x 18"  
GF AFMFEX937GF  
GP AFMFEX937GP



Mat'l 14" x 20"  
GF AFMFEX933GF  
GP AFMFEX933GP



14" x 20"  
GF AFMFEX936GF  
GP AFMFEX936GP



Mat'l 14" x 20"  
GF AFMFEX931GF  
GP AFMFEX931GP



14" x 20"  
GF AFMFEX940GF  
GP AFMFEX940GP



Mat'l 7" x 17"  
GF AFMFEX941GF  
GP AFMFEX941GP



7" x 17"  
GF AFMFEX942GF  
GP AFMFEX942GP



7" x 17"  
GF AFMFEX943GF  
GP AFMFEX943GP



Material Code	Material	12" x 12"	14" x 20"
		7" x 17"	18" x 18"
GF	Lumi-Glow™ Flex	\$28.73	\$42.42
GP	Lumi-Glow™ Plastic	\$37.57	\$64.20

### Evacuation & Shelter Signs

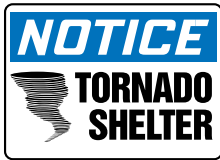

Mat'l 7" x 10" 10" x 14"  
VS AFMFEX800VS AFMADM823VS  
VP AFMFEX800VP AFMADM823VP  
VA AFMFEX800VA AFMADM823VA



14" x 10"  
AFMFEX523VS  
AFMFEX523VP  
AFMFEX523VA



14" x 10"  
AFMFEX524VS  
AFMFEX524VP  
AFMFEX524VA



14" x 10"  
AFSBMFEX524VS  
AFSBMFEX524VP  
AFSBMFEX524VA



7" x 10" 10" x 14"  
AFMFEX506VS AFMFEX528VS  
AFMFEX506VP AFMFEX528VP  
AFMFEX506VA AFMFEX528VA



Mat'l 10" x 14"  
VS AFMFEX529VS  
VP AFMFEX529VP  
VA AFMFEX529VA



10" x 14"  
AFMFEX554VS  
AFMFEX554VP  
AFMFEX554VA



10" x 14"  
AFMFEX550VS  
AFMFEX550VP  
AFMFEX550VA



10" x 14"  
AFMFEX551VS  
AFMFEX551VP  
AFMFEX551VA



24" x 18"  
AFMFEX504VS  
AFMFEX504VP  
AFMFEX504VA

Material Code	Material	7" x 10"	10" x 14"	24" x 18"
VS	Adhesive Vinyl	\$8.31	\$12.46	\$29.42
VP	Plastic	\$9.06	\$13.53	\$30.33
VA	Aluminum	\$12.95	\$21.51	\$49.06

# MARSEC SIGNS

Comply with U.S. Coast Guard, Department of Homeland Security regulations Title 33 – Navigation and Navigable Waters.

Maritime Security (MARSEC) identification signs are designed in bold for quick viewing from a distance. The three level codes designate which security measures are in effect. When Homeland Security issues a National Terrorism Advisory System (NTAS) Alert, the U.S. Coast Guard adjusts the MARSEC level as appropriate to the threat.

Post MARSEC signs at the entrance of a port facility, dock approach, or boarding area of a vessel.



USCG 33CFR 104.265(e)(3) Conspicuously post signs that describe security measures currently in effect and clearly state that: (i) Boarding the vessel is deemed valid consent to screening or inspection; and (ii) Failure to consent or submit to screening or inspection will result in denial or revocation of authorized to board:

USCG 33CFR 105.255 (e)(3) Conspicuously post signs that describe security measures currently in effect and clearly state that: (i) entering the facility is deemed valid consent to screening or inspection; and (ii) Failure to consent or submit to screening or inspection will result in denial or revocation of authorization to enter:



## Standard Set

Each 12" x 18" sign signifies one of the three security code levels. Available in three durable materials for outdoor use.



Mat'l  
VA AFMASE545VA  
XL AFMASE545XL  
XP AFMASE545XP

Material Code	Material	Price / Set
VA	Aluminum	\$86.37
XL	Aluma-Lite™	\$112.04
XP	Accu-Shield™	\$132.11

## Magnetic Set

24" x 36" durable galvanized steel sign includes three 9" x 18" magnetic panels - each represents the three security code levels with color-coded backgrounds. Easily change the magnetic panels on the steel sign as the MARSEC security levels warrant.



24" x 36" AFMASE530

Magnetic Panels - 9" x 18"

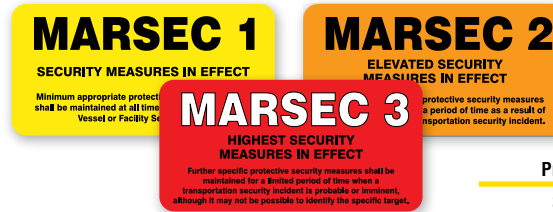

Price / Set  
\$152.11

## Restricted Area Sign

The U.S. Coast Guard and the International Maritime Organization require security signs aboard ships and at port facilities.

Restricted Area signs are to be posted throughout a port facility or on-board a ship or vessel. Identify sensitive security areas designated as off-limits to those unauthorized. Available each in three durable materials for outdoor use.



Ship or Vessel - USCG 33 CFR 104.270 (c)(6), ISPS Part B 9.20  
Port Facility - USCG 33 CFR 105.260 (b) & (c)(6), ISPS Part B 16.12  
Clearly mark all restricted areas and indicate that access to the area is restricted and that unauthorized presence within the area constitutes a breach of security.

Material Code	Material	7" x 10"	10" x 14"	12" x 18"	18" x 24"
VA	Aluminum	\$12.95	\$21.51	\$28.79	\$49.06
XL	Aluma-Lite™	\$16.77	\$27.93	\$37.35	\$62.22
XP	Accu-Shield™	\$19.75	\$32.86	\$44.04	\$87.88

Mat'l	7" x 10"	10" x 14"	12" x 18"	18" x 24"
VA	AFMASE921VA	AFMASE923VA	AFMASE925VA	AFMASE927VA
XL	AFMASE921XL	AFMASE923XL	AFMASE925XL	AFMASE927XL
VP	AFMASE921XP	AFMASE923XP	AFMASE925XP	AFMASE927XP





Oversized banners use bold graphics and words to capture attention and identify the location of safety showers and eyewashes.

The unique vertical banner is printed double-sided making it easily visible from both directions.

40"H x 17"W banner combines high quality printed images with durable, 10-oz. reinforced vinyl, suitable for a wide variety of environments.

Banner is double stitched along with top and bottom hemmed sleeves for added stability. It's quick and easy to install. Mount the metal brackets with arms onto the vertical pipe, then slip the top and bottom of the banner onto the two 22" fiberglass arms.

Mounting hardware included.



40" x 17"

AFMBV900

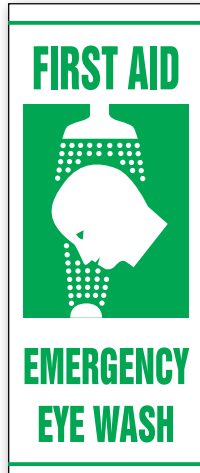

40" x 17"

AFMBV903

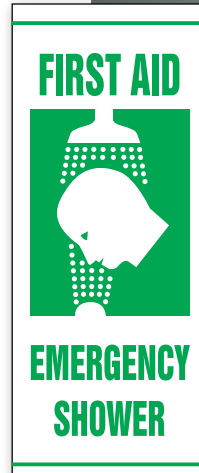

40" x 17"

AFMBV906



**Price / Each**

\$228.99

Bright, attention-getting stripe signs are to identify eyewash and shower stations.

In an emergency, be able to identify the location and equipment for immediate eye and face flush or shower drench.

- Highly visible, bold stripes with contrasting and alternating color combinations
- Distinguishable design stands out against the background in a facility
- In an emergency, even with limited sight, be able to quickly recognize and head toward the sign's colors
- 3-sided sign can be seen from all directions

Each of the three sides is a tall 30" x 8" panel. The sign is open along a leading back edge to slip over and install onto an existing pipe. There are 3/16" mounting holes on the middle panel and back leading edges.

Choose Standard or DG-Reflective for added fluorescent visibility.



Standard style

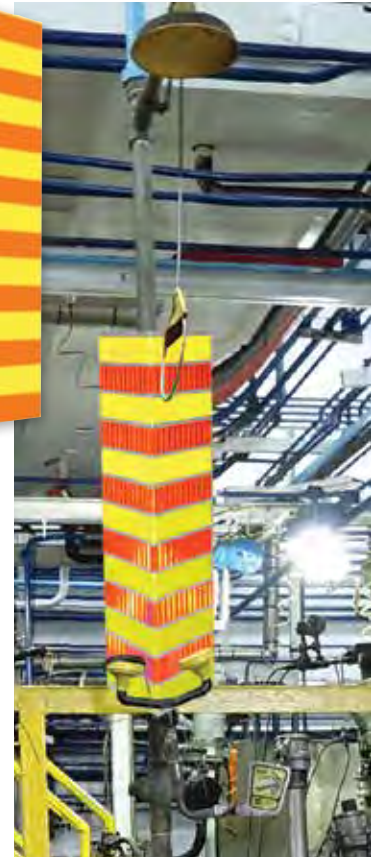

DG-Reflective style style

**STANDARD STYLE**

Has printed color stripes on heavy-duty plastic with UV-overlaminated protection from weathering and fading, abrasions, scratches, and chemical splash. For indoor and outdoor use.

Color	Part #	Price / Each
Orange/Yellow	AFMFSD975ORYL	\$136.59
Orange/Green	AFMFSD975ORGN	\$136.59
Orange/White	AFMFSD975ORWT	\$136.59
Black/Yellow	AFMFSD975BKYL	\$136.59

**DG-REFLECTIVE STYLE**

Has DG High-Prism fluorescent color stripes for superior visibility – even under low light conditions. Stripes bonded to the heavy-duty plastic have excellent resistance to weather, fade, abrasion, scratches, and chemical splash. Ideal for outdoor exposure.

Color	Part #	Price / Each
Fluorescent Yellow-Green/Fluorescent Orange	AFMFSD405FGFO	\$194.57
Fluorescent Yellow-Green/Fluorescent Yellow	AFMFSD405FGFY	\$194.57
Fluorescent Orange/Fluorescent Yellow	AFMFSD405FOFY	\$194.57

## LABELS

Mat'l VSP XVE								
	AFLC002VSP AFLC002XVE	AFLCSP266VSP AFLCSP266XVE	AFLCSP280VSP AFLCSP280XVE	AFLC795VSP AFLC795XVE	AFLCHL285VSP AFLCHL285XVE	AFLC248VSP AFLC248XVE	AFLCHL293VSP AFLCHL293XVE	AFLCQM279VSP AFLCQM279XVE
Mat'l VSP XVE								
	AFLKKT286VSP AFLKKT286XVE	AFLCQM273VSP AFLCQM273XVE	AFLCQM123VSP AFLCQM123XVE	AFLCQM269VSP AFLCQM269XVE	AFLC153VSP AFLC153XVE	AFLC164VSP AFLC164XVE	AFLCHL675VSP AFLCHL675XVE	AFLCQM780VSP AFLCQM780XVE
Mat'l VSP XVE								
	AFLKKT611VSP AFLKKT611XVE	AFLCQM782VSP AFLCQM782XVE	AFLBHZ506VSP AFLBHZ506XVE	AFLFXG440VSP AFLFXG440XVE	AFLFSD509VSP AFLFSD509XVE			

Printed on Adhesive Vinyl packaged, or Adhesive Dura-Vinyl individually.

Material Code	Material	Size	Price
VSP	Adhesive Vinyl	3-1/2" x 5"	\$12.31 / Pkg. of 5
XVE	Dura Vinyl (5 year guarantee)	3-1/2" x 5"	\$5.17 / Each

## CUSTOM LABELS MADE EASY!

- No set-up fees
- Any print colors you choose, right to the edges
- High-definition, full-color graphics at no additional charge

- Any lettering or font to fit your design
- Also available with bar coding or sequential numbering
- Comprehensive, free design support



### How to Order Custom Labels

#### Step 1: Size, Color

Choose color and size options to accommodate any design.

#### Step 2: Select Print Colors

We can print in any color you want, with no additional charge. Using your company logo? We'll match your colors to print full-color images.

#### Step 3: Create the Layout

Develop your message with words, numbers, bar codes, and in any combination. Include graphics, logos, symbols or full-color images.

#### Step 4: Decide on Quantity

No need to order huge quantities – Start with as few as 25.



### PAPER Labels, Self-Adhesive:

Economical for short-term, temporary, and dry indoor applications – do not expose to moisture.

- 60-lb paper
- Matte surface can be easily written on with pen or pencil
- Permanent acrylic adhesive back with peel-off liner
- Available in any standard background color and select fluorescent backgrounds



Shape / Size	Part #	SHEETS			ROLLS					
		25 - 49	50 - 99	100 - 249	250 - 499	500 - 999	1000 - 1999	2000 - 2999	3000 - 4999	5000+
Circle										
1"	AFLAP110	\$1.19	\$0.79	\$0.48	\$0.37	\$0.28	\$0.25	\$0.20	\$0.14	\$0.11
2"	AFLAP120	\$1.25	\$0.88	\$0.51	\$0.40	\$0.33	\$0.31	\$0.25	\$0.20	\$0.14
3"	AFLAP130	\$1.33	\$0.94	\$0.53	\$0.45	\$0.36	\$0.33	\$0.31	\$0.25	\$0.20
Square										
1" x 1"	AFLAP210	\$1.19	\$0.79	\$0.48	\$0.37	\$0.28	\$0.25	\$0.20	\$0.14	\$0.11
2" x 2"	AFLAP220	\$1.25	\$0.55	\$0.51	\$0.40	\$0.33	\$0.31	\$0.25	\$0.20	\$0.14
3" x 3"	AFLAP230	\$1.33	\$0.94	\$0.53	\$0.45	\$0.36	\$0.33	\$0.31	\$0.25	\$0.20
Oval										
1-1/2" x 3"	AFLAP330	\$1.25	\$0.88	\$0.51	\$0.40	\$0.33	\$0.31	\$0.25	\$0.20	\$0.14
Rectangle										
1" x 2"	AFLAP430	\$1.19	\$0.79	\$0.48	\$0.37	\$0.28	\$0.25	\$0.20	\$0.14	\$0.11
2" x 3"	AFLAP454	\$1.33	\$0.94	\$0.53	\$0.45	\$0.36	\$0.33	\$0.31	\$0.25	\$0.20
2" x 4"	AFLAP460	\$1.33	\$0.94	\$0.53	\$0.45	\$0.36	\$0.33	\$0.31	\$0.25	\$0.20
3" x 5"	AFLAP480	\$1.36	\$0.97	\$0.56	\$0.48	\$0.37	\$0.36	\$0.33	\$0.28	\$0.25
Other Shapes										
Other Sizes	AFLAP555	Call for quote								

## Vinyl Labels, Self-Adhesive:

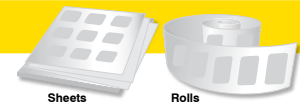

Moisture- and tear-resistant vinyl labels have clear overlamine for added protection. Labels resist dirt, grease, chemical splash, scuffs, abrasions, fading and weather conditions.

- Ideal for placement indoor and outdoor use, up to 2 years
- Easy to clean, wipe-off surface
- 5-mil label is printed vinyl with clear protective top layer
- Permanent acrylic adhesive back with peel-off liner
- Available in any background color, including clear to provide "print-only" look
- When ordering, specify color(s) or clear background

When ordering, choose clear overlamine by part number:

**Writable Surface** – Ideal when information needs to be filled in on the spot. Clear matte top can be easily written on with any marker, pen, or pencil.

**Gloss Surface** – Easily wipe off dust, dirt, and grease. The print image has a sharp appearance through the clear shiny top.

Shape / Size	Writable Surface #	Gloss Surface #	SHEETS			ROLLS								
			25 - 49	50 - 99	100 - 249	250 - 499	500 - 999	1000 - 1999	2000 - 2999	3000 - 4999	5000+			
Circle														
1"	AFLAR113	AFLAW111	\$2.02	\$1.33	\$0.71	\$0.65	\$0.40	\$0.36	\$0.33	\$0.28	\$0.20			
1-1/2"	AFLAR117	AFLAW116	\$2.02	\$1.33	\$0.71	\$0.65	\$0.40	\$0.36	\$0.33	\$0.28	\$0.20			
2"	AFLAR122	AFLAW121	\$2.05	\$1.36	\$0.73	\$0.71	\$0.53	\$0.45	\$0.39	\$0.33	\$0.28			
2-1/2"	AFLAR127	AFLAW126	\$2.08	\$1.39	\$0.79	\$0.73	\$0.59	\$0.53	\$0.40	\$0.36	\$0.33			
3"	AFLAR132	AFLAW131	\$2.08	\$1.39	\$0.79	\$0.73	\$0.59	\$0.53	\$0.40	\$0.36	\$0.33			
Square														
1" x 1"	AFLAR212	AFLAW211	\$2.02	\$1.33	\$0.71	\$0.65	\$0.40	\$0.36	\$0.33	\$0.28	\$0.20			
2" x 2"	AFLAR222	AFLAW221	\$2.05	\$1.36	\$0.73	\$0.71	\$0.53	\$0.45	\$0.39	\$0.33	\$0.28			
3" x 3"	AFLAR232	AFLAW231	\$2.08	\$1.39	\$0.79	\$0.73	\$0.59	\$0.53	\$0.40	\$0.36	\$0.33			
4" x 4"	AFLAR242	AFLAW241	\$2.17	\$1.53	\$0.82	\$0.79	\$0.65	\$0.59	\$0.45	\$0.40	\$0.39			
Oval														
1-1/2" x 3"	AFLAR332	AFLAW331	\$2.05	\$1.36	\$0.73	\$0.71	\$0.53	\$0.45	\$0.39	\$0.33	\$0.28			
Rectangle														
1" x 2"	AFLAR432	AFLAW431	\$2.02	\$1.33	\$0.71	\$0.65	\$0.40	\$0.36	\$0.33	\$0.28	\$0.20			
2" x 3"	AFLAR457	AFLAW456	\$2.08	\$1.39	\$0.79	\$0.73	\$0.59	\$0.53	\$0.40	\$0.36	\$0.33			
2" x 4"	AFLAR460	AFLAW461	\$2.08	\$1.39	\$0.79	\$0.73	\$0.59	\$0.53	\$0.40	\$0.36	\$0.33			
3" x 5"	AFLAR482	AFLAW481	\$2.17	\$1.53	\$0.82	\$0.79	\$0.65	\$0.59	\$0.45	\$0.40	\$0.39			
4" x 6"	AFLAR495	AFLAW496	\$2.48	\$1.85	\$1.11	\$0.91	\$0.73	\$0.68	\$0.59	\$0.53	\$0.48			
Other Shapes														
Other Sizes	AFLAR555	AFLAW555	Call for quote											

## HIGH-PERFORMANCE Labels, Self-Adhesive:



Place our most durable, flexible labels on equipment, machinery, and tools that are repeatedly handled and exposed to abusive and harsh conditions. Printed label has clear UV protective coating, engineered to offer excellent protection from chemicals and abrasions.

- Ideal for long-term outdoor exposure.
- High clarity keeps the label message intact and legible.
- Surface withstands rough handling from marks and scratches
- Wipe dust, dirt, and grease off surface – resists over-marking (or graffiti)
- Available in any background color, including clear to provide "print-only" look
- When ordering, specify color(s) or clear background

Shape / Size	Part #	SHEETS			ROLLS						
		25 - 49	50 - 99	100 - 249	250 - 499	500 - 999	1000 - 1999	2000 - 2999	3000 - 4999	5000+	
Circle											
1"	AFLAL115	\$2.65	\$1.76	\$1.05	\$0.82	\$0.53	\$0.45	\$0.40	\$0.33	\$0.25	
2"	AFLAL125	\$2.79	\$1.93	\$1.08	\$0.91	\$0.68	\$0.59	\$0.48	\$0.40	\$0.33	
3"	AFLAL134	\$2.96	\$2.05	\$1.17	\$0.97	\$0.73	\$0.68	\$0.53	\$0.48	\$0.40	
Square											
1" x 1"	AFLAL214	\$2.65	\$1.76	\$1.05	\$0.82	\$0.53	\$0.45	\$0.40	\$0.33	\$0.25	
2" x 2"	AFLAL224	\$2.79	\$1.93	\$1.08	\$0.91	\$0.68	\$0.59	\$0.48	\$0.40	\$0.33	
3" x 3"	AFLAL235	\$2.96	\$2.05	\$1.17	\$0.97	\$0.73	\$0.68	\$0.53	\$0.48	\$0.40	
Oval											
1-1/2" x 3"	AFLAL335	\$2.79	\$1.93	\$1.08	\$0.91	\$0.68	\$0.59	\$0.48	\$0.40	\$0.33	
Rectangle											
1" x 2"	AFLAL434	\$2.65	\$1.76	\$1.05	\$0.82	\$0.53	\$0.45	\$0.40	\$0.33	\$0.25	
2" x 3"	AFLAL459	\$2.96	\$2.05	\$1.17	\$0.97	\$0.73	\$0.68	\$0.53	\$0.48	\$0.40	
2" x 4"	AFLAL462	\$2.96	\$2.05	\$1.17	\$0.97	\$0.73	\$0.68	\$0.53	\$0.48	\$0.40	
3" x 5"	AFLAL484	\$2.99	\$2.11	\$1.25	\$1.05	\$0.82	\$0.73	\$0.59	\$0.53	\$0.48	
Other Shapes											
Other Sizes	AFLAL555	Call for quote									

Don't see what you're looking for? Additional materials and sizes are available. Call us for details.



Header style tags meet Occupational Safety and Health Administration requirements. Choose from a variety of common styles and legends that apply to a variety of situations. Tags are available in two materials: PF-Cardstock and RP-Plastic. Sold in pack of 25.

### PF-Cardstock

- 5-3/4" x 3 1/4" with 3/8" hole
- Pliable, 10-mil polyolefin-based material
- Pulp-free, no wood-paper content
- Waterproof, tear-resistant for light-duty use



### RP-Plastic

- 5-3/4" x 3 1/4" with 3/8" hole, reinforced with metal grommet
- 15-mil tear-resistant plastic
- Weather- and chemical-resistant



## Standard Safety Tags

					
	SIGNED BY: _____ DATE: _____	SIGNED BY: _____ DATE: _____	SIGNED BY: _____ DATE: _____	SIGNED BY: _____ DATE: _____	SIGNED BY: _____ DATE: _____
	AFMDT185CTP AFMDT185PTP	AFMDT187CTP AFMDT187PTP	AFMDT189CTP AFMDT189PTP	AFMDT250CTP AFMDT250PTP	AFMDT225CTP AFMDT225PTP
Mat'l PF-Cardstock RP-Plastic					
					
	SIGNED BY: _____ DATE: _____	SIGNED BY: _____ DATE: _____	SIGNED BY: _____ DATE: _____	SIGNED BY: _____ DATE: _____	(header from front) DO NOT REMOVE THIS TAG! REMARKS: _____ DATE: _____ SEE OTHER SIDE
	AFMDT219CTP AFMDT219PTP	AFMDT246CTP AFMDT246PTP	AFMDT623CTP AFMDT623PTP	AFMDT626CTP AFMDT626PTP	STANDARD BACK
Mat'l PF-Cardstock RP-Plastic					

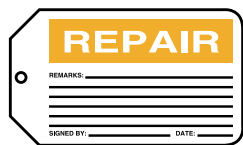
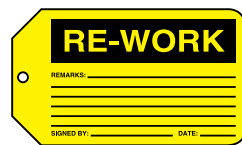
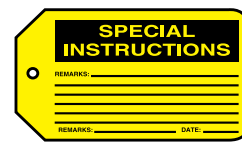
## Production Control Tags

					
	REMARKS: _____ SIGNED BY: _____ DATE: _____	REMARKS: _____ SIGNED BY: _____ DATE: _____	REMARKS: _____ SIGNED BY: _____ DATE: _____	REMARKS: _____ SIGNED BY: _____ DATE: _____	REMARKS: _____ SIGNED BY: _____ DATE: _____
	Blank Back AFMMT301CTP AFMMT301PTP	Blank Back AFMMT300CTP AFMMT300PTP	Blank Back AFMMT315CTP AFMMT315PTP	Blank Back AFMMT306CTP AFMMT306PTP	Blank Back AFMMT307CTP AFMMT307PTP
Mat'l PF-Cardstock RP-Plastic					

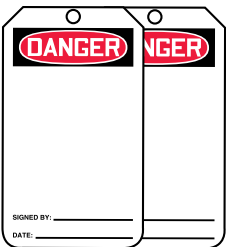
## Blank Header Tags

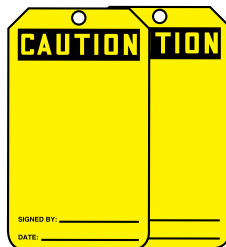
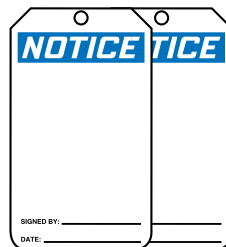
				
	SIGNED BY: _____ DATE: _____	SIGNED BY: _____ DATE: _____	SIGNED BY: _____ DATE: _____	SIGNED BY: _____ DATE: _____
	Front Back AFMDT260CTP AFMDT260PTP	Front Back AFMWGT205CTP AFMWGT205PTP	Front Back AFMGT200CTP AFMGT200PTP	Front Back AFMNT101CTP AFMNT101PTP
Mat'l PF-Cardstock RP-Plastic				

Material Code	Material	Size	Price / Pkg. 25
CTP	PF-Cardstock	5-3/4" x 3-1/4"	\$14.93
PTP	RP-Plastic	5-3/4" x 3-1/4"	\$40.53

# Equipment Status & Inspection Tags

## Fire Extinguisher Records

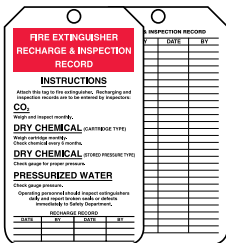

Mat'l  
PF-Cardstock  
RP-Plastic

Front Back  
AFMGT208CTP  
AFMGT208PTP



Front Back  
AFTRS218CTP  
AFTRS218PTP

## Scaffold Tags



Front Back  
AFTSS102CTP  
AFTSS102PTP



Front Back  
AFTSS101CTP  
AFTSS101PTP



Front Back  
AFTSS103CTP  
AFTSS103PTP

## Inspection Records

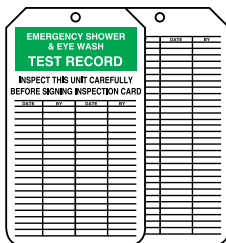

Mat'l  
PF-Cardstock  
RP-Plastic

Front Back  
AFMGT207CTP  
AFMGT207PTP



Front Back  
AFTRS305CTP  
AFTRS305PTP



Front Back  
AFTRS307CTP  
AFTRS307PTP

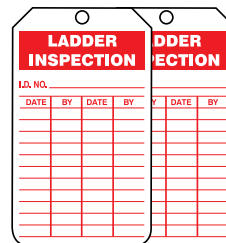

Front Back  
AFTRS248CTP  
AFTRS248PTP

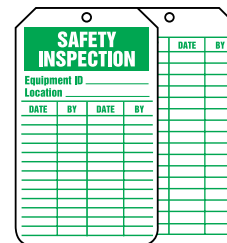

Front Back  
AFTRS315CTP  
AFTRS315PTP

## Barricade, Cylinder & Service Status



Mat'l  
PF-Cardstock  
RP-Plastic

Front Back  
AFTAB105CTP  
AFTAB105PTP

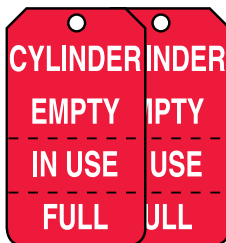

Front Back  
AFMGT206CTP  
AFMGT206PTP  
Perforated



Front Back  
AFMGT219CTP  
AFMGT219PTP



Front Back  
AFMGT217CTP  
AFMGT217PTP



Front Back  
AFTRS243CTP  
AFTRS243PTP

## Lockout Tags



Mat'l  
PF-Cardstock  
RP-Plastic

AFMLT409CTP  
AFMLT409PTP



AFMLT406CTP  
AFMLT406PTP



AFMLT400CTP  
AFMLT400PTP



AFMLT407CTP  
AFMLT407PTP

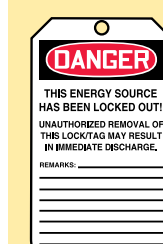

STD LOCKOUT BACK

Material Code	Material	Size	Price / Pkg. 25
CTP	PF-Cardstock	5-3/4" x 3-1/4"	\$14.93
PTP	RP-Plastic	5-3/4" x 3-1/4"	\$40.53



**Loop 'n Strap™ Tags**

- Attach tags by self-fastening strap for quick marking
- .014" polyethylene plastic tags resist dirt, grease and moisture
- Write on tag with permanent marker
- Tag size: 5-1/4"H x 3-1/4"W, with 1-3/8"W x 6" long strap
- Available in packages of 25



Price / Pkg. of 25

\$40.53

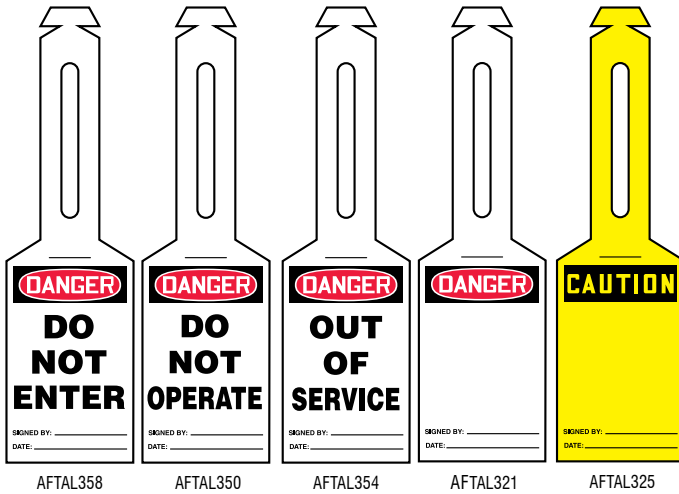

**Loop 'n Lock™ Tie Tags**

- 15-mil RP-Plastic tag
- Self-locking, ribbed strap is 8" long with 50-lb pull strength rating
- Tag size: 5-3/4"H x 3-1/4"W
- Available in packages of 10

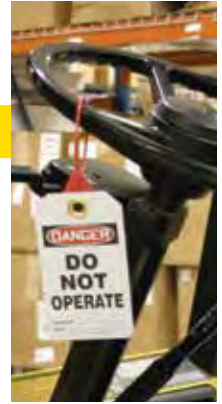

Price / Pkg. of 10

\$33.82



**Perma-Tags™**

- Stands up to the harshest industrial environments
- Injection-molded recycled polycarbonate plastic with raised legends on both sides
- Overall size: 5-7/16"H x 3-1/16"W x 1/8" thick
- 3/8" hole without grommet meets dielectric requirements
- Write in information with permanent marker
- Available in packages of 25

Price / Pkg. of 25

\$54.99

**Hanger Tags**

- Slip Hanger Tags onto any door knob handle or hook
- 9"H x 4"W, 15-mil RP-Plastic tag
- Message repeated both sides
- Available in packages of 10

Style Price / Pkg. of 10

Standard	\$28.53
Glow	\$32.91

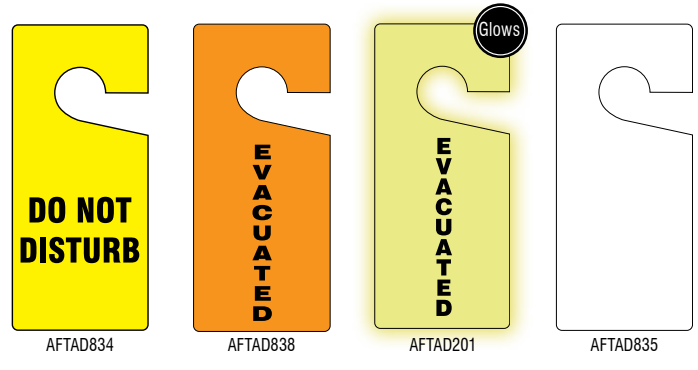



## CUSTOM TAGS MADE EASY!

- No set-up fees
- Any print colors
- Full-color graphics and images, including design, image, and logo
- Choose a message with any letter font
- Available barcoding, sequential numbering, and tear-off perforations – Call us for details



### How to Order Custom Tags

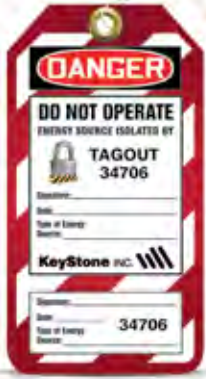

#### Step 1: Message, Design

Develop your tag – provide message, layout, design and color.

#### Step 2: Select Material and Size

Consider tag placement, intended application, and environment.

#### Step 3: Finishing Options

Determine how you will install the tag. Call us for available options.

#### Step 4: Decide on Quantity

No need to order huge quantities – You can order as few as 25.

Call, email, or fax us to place your order!

### PF-Cardstock Tags **PFCARDSTOCK**

Tear-resistant and waterproof tags last longer than standard cardstock tags.

Tags are pulp-free – no wood pulp or paper content – unlike regular cardstock. They are pliable, yet will not rip or breakdown in moisture. Tags do not tear readily when tugged on. Ideal for indoor use and short-term outdoor exposure. The scuff-resistant, matte surface is easy to write on.

- 10-mil polyolefin-based material
- Thin and flexible
- Top has 3/8" plain hole

Size	Part #	25 - 49	50 - 99	100 - 249	250 - 499	500 - 999	1000+
4-1/4" x 2-1/8"	AFCT42	\$1.79	\$1.59	\$1.19	\$0.82	\$0.53	\$0.39
5-3/4" x 3-1/4"	AFCT63	\$2.42	\$1.88	\$1.51	\$1.11	\$0.71	\$0.51
8-1/2" x 3-7/8"	AFCT84	\$3.05	\$2.25	\$1.93	\$1.45	\$0.99	\$0.71
Other Sizes	AFCT555	Call for quote					

### RP-Plastic Tags

Durable tag withstands pulls and tears in dirty and greasy environments. Plastic tags are water-resistant – to withstand weather conditions. The rigid plastic is flexible, yet will not readily break down over a wide temperature range. Good for indoors and outdoors use. Writable surface is abrasion resistant.

- 15-mil rigid plastic material
- Flexible, yet durable – withstands stretching and ripping
- Top has 3/8" hole reinforced with metal grommet to prevent pull off

Size	Part #	25 - 49	50 - 99	100 - 249	250 - 499	500 - 999	1000+
4-1/4" x 2-1/8"	AFRT42	\$3.71	\$3.05	\$2.45	\$1.82	\$1.20	\$0.91
5-3/4" x 3-1/4"	AFRT63	\$4.34	\$3.48	\$2.68	\$2.05	\$1.36	\$1.14
8-1/2" x 3-7/8"	AFRT84	\$5.19	\$4.25	\$3.34	\$2.39	\$1.60	\$1.45
Other Sizes	AFRT555	Call for quote					

### HS-Laminate Tags

Tags are designed to withstand tough and abusive conditions.

HS-Laminate is a composite of all poly materials hard sealed on both sides with no edge seams. Matte surface is scratch resistant, yet easy to write on. Waterproof tags are ideal for extreme weather conditions.

- Tear-proof, weather-proof, chemical-resistant material withstands dirty and greasy environments
- Thick laminate stands up to abuse and rough handling
- 3/8" top hole is reinforced with a pull-proof, metal grommet

Size	Part #	25 - 49	50 - 99	100 - 249	250 - 499	500 - 999	1000+
4-1/4" x 2-1/8"	AFLT42	\$5.60	\$4.73	\$3.99	\$3.05	\$2.20	\$1.76
5-3/4" x 3-1/4"	AFLT63	\$6.08	\$4.99	\$4.02	\$3.31	\$2.45	\$1.96
8-1/2" x 3-7/8"	AFLT84	\$6.51	\$5.51	\$4.68	\$3.73	\$2.82	\$2.34
Other Sizes	AFLT555	Call for quote					

### Tags By-The-Roll — Never Run Out Of Tags Again!

#### PFCARDSTOCK

- Tag size: 6-1/4" x 3", with 3/8" hole
- 10-mil PF-Cardstock tags
- Tear-resistant, waterproof 'pulp-free' material
- Writable matte surface
- Dispenser size: 9-5/8" x 6-5/8" x 3-5/8"
- Available in rolls of 100 or 250 tags

Per Roll	Price / Roll
100	\$47.20
250	\$104.88



Front Back  
100 / Roll AFTAR110 250 / Roll AFTAR121



Front Back  
100 / Roll AFTAR412 250 / Roll AFTAR423



Front Back  
100 / Roll AFTAR114 250 / Roll AFTAR125

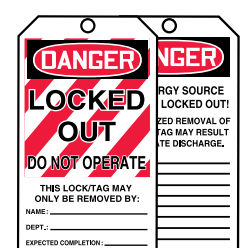

Front Back  
100 / Roll AFTAR416 250 / Roll AFTAR426



Labels follow the information guidelines specified by the GHS and must include OSHA's required label elements. For GHS and DOT pictogram combination labels, larger label sizes are recommended. The DOT requires that transport pictograms be at least 4" x 4". OSHA publishes no size requirements for the GHS label or GHS pictograms, but it is recommended the label elements be proportionate to each other.



HCS 2012 Final Rule, March 26, 2012

(f)(1) Labels on shipped containers. The chemical manufacturer, importer, or distributor shall ensure that each container of hazardous chemicals leaving the workplace is labeled, tagged, or marked. Hazards not otherwise classified do not have to be addressed on the container. Where the chemical manufacturer or importer is required to label, tag or mark the following information shall be provided: (i) Product identifier; (ii) Signal word; (iii) Hazard statement(s); (iv) Pictogram(s); (v) Precautionary statement(s); and, (vi) Name, address, and telephone number of the chemical manufacturer, importer, or other responsible party.

**How to order:** Specify size of label. Send us your required label information. Provide guidance on label design if different from examples. Indicate desired material. Specify quantity. Contact us with your request; we'll put together your specifications and send you a proof (upon request)

*Note: You are required to provide all necessary information, specific to your hazardous chemical or material, to complete an accurate and safe label for your premises.*



1.4.10.5.4.1 Location of GHS information on the label

"The GHS hazard pictograms, signal word and hazard statements should be located together on the label. The competent authority may choose to provide a specified layout for the presentation of these and for the presentation of precautionary information, or allow supplier discretion."



Format 1: Custom GHS Pictogram Label

#### Required Label Elements

- 1 Product Identifier – Should match the product identifier used on the Safety Data Sheets.
- 2 Signal Word – Indicates the relative level of the hazard's severity. "Danger" and "Warning" are the GHS signal words.
- 3 Pictograms – Graphic compositions intended to convey specific hazard information.
- 4 Hazard Statements – A phrase assigned to a hazard class and category that describes the nature of the product hazards.
- 5 Precautionary Statements – Describe recommended measures to minimize or prevent adverse effects resulting from exposure.
- 6 Supplier Identification – The name, address and telephone number of the manufacturer or supplier.

Format 2: Custom GHS and DOT Pictogram Combination Label

Actual label design and layout may vary and are subject to the discretion of the competent authority.

#### Dura-Vinyl™

Flexible 6-mil thick poly-composite has self-adhesive acrylic back. Peel-off liner and pressure-sensitive back permanently adheres to smooth, curved, and irregular surfaces. Protective high-gloss UV protective coating provides environmental and outdoor durability. Resists abrasions, humidity, moisture, chemicals, solvents, and sunlight fade.

Size	Part #	25	50 - 99	100 - 249	250 - 499	500+
3" x 4"	AFLZH451	\$2.20	\$1.68	\$0.99	\$0.97	\$0.94
4" x 6"	AFLZH452	\$6.05	\$2.28	\$1.91	\$1.82	\$1.76
6" x 8"	AFLZH453	\$8.11	\$4.48	\$4.08	\$3.88	\$3.76
9" x 12"	AFLZH473*	\$9.28	\$5.33	\$4.93	\$4.71	\$4.54
10" x 14"	AFLZH476*	\$12.13	\$8.16	\$7.76	\$7.36	\$7.17
Other Sizes	AFLZH455	Call for quote				

\*Sizes recommended for combination labels

Pictogram labels comply with the Globally Harmonized System.

GHS pictograms identify the hazards associated with chemicals and warn users of the types of precautions that should be taken to minimize adverse effects that could result from exposure. The GHS recognizes nine hazard pictograms. The Hazard Communication Standard (HCS) requires eight of these pictograms with the exception the environment pictogram (considered non-mandatory since environmental hazards fall outside OSHA's jurisdiction).

Labels are available in Adhesive Coated Paper and Adhesive-Poly Sheet. Available by the roll in quantities of 250 or 500.



C.2.3.1 Pictograms shall be in the shape of a square set at a point and shall include a black hazard symbol on a white background with a red frame sufficiently wide to be clearly visible. A square red frame set at a point without a hazard symbol is not a pictogram and is not permitted on the label.



Flame



Flame Over Circle



Exploding Bomb



Corrosion



Gas Cylinder

	1" x 1"		2" x 2"		1" x 1"		2" x 2"		1" x 1"		2" x 2"	
Adhesive Coated Paper												
250 Roll	AFLZH601PS2	AFLZH611PS2	AFLZH602PS2	AFLZH612PS2	AFLZH603PS2	AFLZH613PS2	AFLZH604PS2	AFLZH614PS2	AFLZH605PS2	AFLZH615PS2	AFLZH606PS2	AFLZH616PS2
500 Roll	AFLZH601PS5	AFLZH611PS5	AFLZH602PS5	AFLZH612PS5	AFLZH603PS5	AFLZH613PS5	AFLZH604PS5	AFLZH614PS5	AFLZH605PS5	AFLZH615PS5	AFLZH606PS5	AFLZH616PS5
Adhesive-Poly Sheet												
250 Roll	AFLZH601EV2	AFLZH611EV2	AFLZH602EV2	AFLZH612EV2	AFLZH603EV2	AFLZH613EV2	AFLZH604EV2	AFLZH614EV2	AFLZH605EV2	AFLZH615EV2	AFLZH606EV2	AFLZH616EV2
500 Roll	AFLZH601EV5	AFLZH611EV5	AFLZH602EV5	AFLZH612EV5	AFLZH603EV5	AFLZH613EV5	AFLZH604EV5	AFLZH614EV5	AFLZH605EV5	AFLZH615EV5	AFLZH606EV5	AFLZH616EV5



Skull & Crossbones



Exclamation Mark



Non-mandatory Environment



Health Hazard

	1" x 1"		2" x 2"		1" x 1"		2" x 2"		1" x 1"		2" x 2"	
Adhesive Coated Paper												
250 Roll	AFLZH606PS2	AFLZH616PS2	AFLZH607PS2	AFLZH617PS2	AFLZH608PS2	AFLZH618PS2	AFLZH609PS2	AFLZH619PS2	AFLZH606PS2	AFLZH616PS2	AFLZH607PS2	AFLZH617PS2
500 Roll	AFLZH606PS5	AFLZH616PS5	AFLZH607PS5	AFLZH617PS5	AFLZH608PS5	AFLZH618PS5	AFLZH609PS5	AFLZH619PS5	AFLZH606PS5	AFLZH616PS5	AFLZH607PS5	AFLZH617PS5
Adhesive-Poly Sheet												
250 Roll	AFLZH606EV2	AFLZH616EV2	AFLZH607EV2	AFLZH617EV2	AFLZH608EV2	AFLZH618EV2	AFLZH609EV2	AFLZH619EV2	AFLZH606EV2	AFLZH616EV2	AFLZH607EV2	AFLZH617EV2
500 Roll	AFLZH606EV5	AFLZH616EV5	AFLZH607EV5	AFLZH617EV5	AFLZH608EV5	AFLZH618EV5	AFLZH609EV5	AFLZH619EV5	AFLZH606EV5	AFLZH616EV5	AFLZH607EV5	AFLZH617EV5

**Custom GHS Pictogram Labels**  
Custom sizes and materials are available. Contact us with part number AFLZH655 for a quote.

ADHESIVE COATED PAPER			
Qty.	Code	1" x 1"	2" x 2"
250	PS2	\$15.44	\$18.24
500	PS5	\$24.71	\$29.31

ADHESIVE-POLY SHEET			
Qty.	Code	1" x 1"	2" x 2"
250	EV2	\$23.92	\$28.28
500	EV5	\$13.28	\$45.44

Keep a visual reminder of GHS label and pictogram requirements close at hand for easy reference.

Plastic wallet card measures 3 3/8" x 2 1/8" and is double sided. One side of the wallet card shows a representation of the nine standard GHS pictograms, while the flip side shows a GHS label example.

Item	Part #	Price / Each
English	AFLKC241	\$2.64
Spanish	AFSHLK241	\$2.64

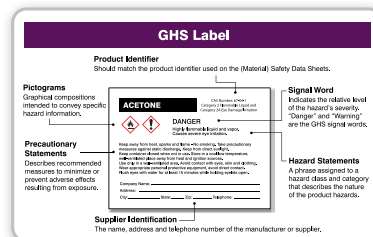

English Front  
AFLKC241

**GHS Pictograms**

Flame  
(Flammable)

Flame Over Circle  
(Oxidizing)

Exploding Bomb  
(Explosive)

Corrosive  
(Corrosive)

Gas Cylinder  
(Gases Under Pressure)

Skull & Crossbones  
(Acute Toxicity)

Exclamation Mark  
(Irritants/Sensitizers/  
Other Hazards)

Environment  
(Aquatic Hazards)

Health Hazard  
(Specific Toxicity  
Hazards)

English Back



### NFPA Placard Signs

- Displays the four-color NFPA diamond format
- Sign available to be filled by hand, or as kit with clear polyester adhesive numbers and symbols
- Choose from English or Bilingual Spanish
- Available in Adhesive Vinyl, Plastic or .040" Aluminum



Size	Adhesive Vinyl	Plastic	Aluminum	KIT	10" x 7"	14" x 10"	10" x 7"	14" x 10"
<b>KIT</b>				Adhesive Vinyl	AFZFD814VS	AFZFD837VS	AFSBZFD881VS	AFSBZFD889VS
10" x 7"	\$22.37	\$23.13	\$27.00	Plastic	AFZFD814VP	AFZFD837VP	AFSBZFD881VP	AFSBZFD889VP
14" x 10"	\$28.59	\$29.66	\$37.64	Aluminum	AFZFD814VA	AFZFD837VA	AFSBZFD881VA	AFSBZFD889VA
<b>SIGN ONLY</b>				Adhesive Vinyl	AFZFD806VS	AFZFD807VS	AFSBZFD870VS	AFSBZFD878VS
10" x 7"	\$8.31	\$9.06	\$12.95	Plastic	AFZFD806VP	AFZFD807VP	AFSBZFD870VP	AFSBZFD878VP
14" x 10"	\$12.46	\$13.53	\$21.51	Aluminum	AFZFD806VA	AFZFD807VA	AFSBZFD870VA	AFSBZFD878VA

### Hazardous Material Classification Signs

Properly identify the four hazard ratings of chemicals and materials on hand.

- Post on or in area of chemical containers
- Write in hazard ratings and chemical name for on-the-spot identification



Material Code	Material	10" x 7"	Mat'l	10" x 7"	10" x 7"	10" x 7"
VS	Adhesive Vinyl	\$8.31	VS	AFZFD801VS	AFZFD840VS	AFZFD841VS
VP	Plastic	\$9.06	VP	AFZFD801VP	AFZFD840VP	AFZFD841VP

### Right-To-Know PPE Labels

- Fill in hazard codes and select applicable equipment code
- Printed on self-adhesive vinyl
- Use Clear Overlaminates for added protection

Size	HMCIS Part #	NFPA Part #	Price / Each
3-1/2" x 5"	AFLZS415	AFLZN111	\$2.60
5" x 7"	AFLZS416	AFLZN112	\$6.02

Size	Part #	Price / Each
3-1/2" x 5"	AFLZS155	\$1.31
5" x 7"	AFLZS156	\$3.02

### Chemical Identifier Roll Labels

Identify hazardous chemicals with appropriate information.

- Write-in chemical name, hazard ratings, and PPE
- Self-Laminating has clear flap to protect writing
- Pressure Sensitive Paper or Adhesive Vinyl in Roll of 500
- Self-Laminating Vinyl in Roll of 100

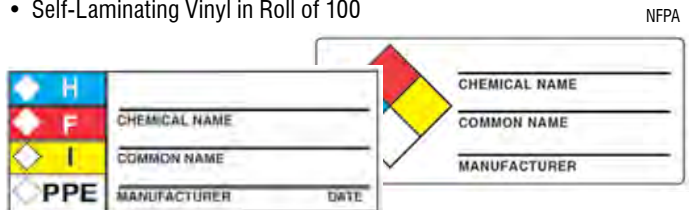

Material/Size	NFPA Part #	HMCIS Part #	Price / Roll of 500
Pressure Sensitive Paper, 1-1/2" x 3-7/8"	AFLZN601PS	AFLZS611PS	\$34.68
Adhesive Vinyl, 1-1/2" x 3-7/8"	AFLZN601EV	AFLZS611EV	\$53.82
Material/Size	NFPA Part #	HMCIS Part #	Price / Roll of 100
Self-Laminating Vinyl, 1" x 3"	AFLZN401EV	AFLZS321EV	\$39.40

## Training Posters

- Inform employees and support your hazard communication program.
- Plastic laminated posters provide instructional information regarding chemical identification and hazard communication – as part of your employees' "Right-To-Know"
  - Available each

Style	Part #	Price / Each
SDS	AFZTP133	\$39.91
Haz-Com	AFZTP122	\$29.48

**HAZ-COM / HAZ-MAT WARNING SYMBOLS**

**CHEMICAL HAZARDS IN THIS AREA**

Labels include: HEALTH HAZARD, FIRE HAZARD, SPECIFIC HAZARD, INSTABILITY, and PROTECTIVE EQUIPMENT INDEX.

These symbols are for IMMEDIATE WARNING—REFER TO SDS FOR DETAILED INFORMATION

Part # AFZTP133, Price \$39.91

## Wallet Cards

- Quick reference fits in employee's pocket.
- Color-printed plastic in three front styles: NFPA, HMCIS, and Combo
  - Back features hazard rating code index definitions
  - Measures 2-1/8" x 3-3/8"
  - Available each

**HAZARDOUS MATERIALS CLASSIFICATION**

Health Hazard (1-4), Fire Hazard (1-4), Specific Hazard (0-5), Instability (0-4).

**HAZARDOUS MATERIAL CODE IDENTIFICATION**

Health (1-4), Flammability (0-4), Instability (0-4), Specific Hazard (0-5).

Part # AFTHS200, Price \$2.64

## NFPA Placard Sign Kits

- Easy installation and convenient for instant on-site classification of chemical hazard identification.
- Kit includes: 1 blank placard, 15 numbers (3 sets of 0-4), six symbols, and NFPA wallet guide
  - 4-mil Adhesive Vinyl placards with clear, self-adhesive hazard panels
  - Blank colored placards and self-adhesive hazard panels also available separately

Size	PLACARD KIT Part #	Price / Kit	BLANK PLACARD Part #	Price / Each
4" x 4"	AFZFD404EV	\$16.86	AFMBLEV4	\$2.59
6" x 6"	AFZFD606EV	\$26.24	AFMBLEV6	\$6.02
10" x 10"	AFZFD101EV	\$37.28	AFMBLEV10	\$12.46
15" x 15"	AFZFD151EV	\$58.28	AFMBLEV15	\$22.02

### Hazard Panels



NUMBER HAZARD PANELS Fits Placard	Char. Height	No. 0 Part #	No.1 Part #	No. 2 Part #	No. 3 Part #	No. 4 Part #	Price / Each
4" x 4"	1"	AFNAP1110	AFNAP1111	AFNAP1112	AFNAP1113	AFNAP1114	\$1.19
6" x 6"	2"	AFNAP1310	AFNAP1311	AFNAP1312	AFNAP1313	AFNAP1314	\$1.33
10" x 10"	4"	AFNAP1510	AFNAP1511	AFNAP1512	AFNAP1513	AFNAP1514	\$1.55
15" x 15"	6"	AFNAP1710	AFNAP1711	AFNAP1712	AFNAP1713	AFNAP1714	\$3.02

SYMBOL HAZARD PANELS Fits Placard	Char. Height	RAD Part #	COR Part #	ACD Part #	ALK Part #	WTR Part #	OXY Part #	Price / Each
4" x 4"	1"	AFNAP120RAD	AFNAP120COR	AFNAP120ACD	AFNAP120ALK	AFNAP120WTR	AFNAP120OXY	\$1.19
6" x 6"	2"	AFNAP140RAD	AFNAP140COR	AFNAP140ACD	AFNAP140ALK	AFNAP140WTR	AFNAP140OXY	\$1.33
10" x 10"	4"	AFNAP160RAD	AFNAP160COR	AFNAP160ACD	AFNAP160ALK	AFNAP160WTR	AFNAP160OXY	\$1.55
15" x 15"	6"	AFNAP180RAD	AFNAP180COR	AFNAP180ACD	AFNAP180ALK	AFNAP180WTR	AFNAP180OXY	\$3.02



**Custom NFPA Placards**  
Adhesive Vinyl placards custom-printed with your numbers and symbols. Call to order. Price per Each.

Size	Part #	1	6 - 9	10 - 24	25 - 49	50+
4" x 4"	AFMCPEV4	\$14.36	\$9.57	\$3.85	\$1.93	\$1.53
6" x 6"	AFMCPEV6	\$20.31	\$12.51	\$7.19	\$5.11	\$1.99
10" x 10"	AFMCPEV10	\$23.97	\$15.93	\$10.25	\$8.05	\$4.71
15" x 15"	AFMCPEV15	\$28.76	\$20.56	\$15.25	\$13.25	\$8.68



**NFPA Flip Placard Sign**

Save time and money by eliminating the need to replace NFPA Placards when hazardous chemicals change.

Give the NFPA Flip Placard Sign a turn of a few panels. Each field contains a side that will reflect the health, flammability, instability and specific hazard information necessary. In seconds, you can display the appropriate NFPA information for the hazardous material.

Consisting of aluminum flip panels, this one convenient sign contains any possible combination to display the proper NFPA hazard information. It has all the necessary colors and severity rating numbers; includes the Use No Water, Oxidizer and Simple Asphyxiant special hazard symbols, recognized by NFPA 704. Also includes the Acid, Alkali, Corrosive and Radiation hazard symbols.

The printed aluminum flip panels are mounted onto sturdy 15 1/2" x 15 1/2" x .063" thick aluminum. Thick .120" clear plastic face plate fits over the placard with a center screw to keep the hazard information in place. The rust-proof, durable aluminum construction is designed to withstand weather and other environmental conditions. Has four 3/16" corner mounting holes.

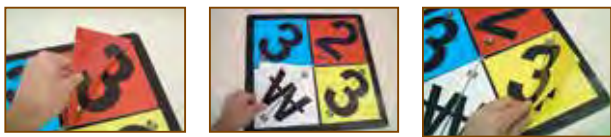

























Part #	Price / Each
AFZPF125	\$182.16

**Shipping Labels**

Ensure safe handling of packages with labeling.

- Labels contain instructions for proper care of package
- Bold graphics and text to be properly understood
- Place in visible location on package
- Adhesive-backed, coated paper on continuous liner
- Roll of 500

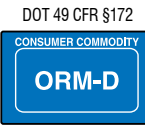
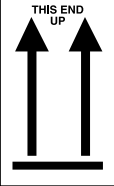
 DO NOT DROP 4" x 3" AFMPC111 6" x 4" AFMPC120	 DO NOT FREEZE 4" x 3" AFMPC123 6" x 4" AFMPC124	 DO NOT STACK 4" x 3" AFMPC117 6" x 4" AFMPC118	 FRAGILE 4" x 3" AFMPC107 6" x 4" AFMPC108	 FRAGILE DO NOT BEND 4" x 3" AFMPC112 6" x 4" AFMPC130			
 KEEP DRY 4" x 3" AFMPC125 6" x 4" AFMPC127	 KEEP FROZEN 4" x 3" AFMPC121 6" x 4" AFMPC122	 PROTECT FROM HEAT 4" x 3" AFMPC135 6" x 4" AFMPC136	 4" x 3" AFMPC128 6" x 4" AFMPC129	 FRAGILE 4" x 4" AFMPC101	 FRAGILE HANDLE WITH CARE 6" x 4" AFMPC103	 THIS END UP FRAGILE 6" x 4" AFMPC102	 FRAGILE 4" x 4" AFMSL226
 FRAGILE DO NOT STACK 4" x 4" AFMPC140	 FRAGILE HANDLE WITH CARE 4" x 4" AFMPC142	 HEAVY 2" x 8" AFMPC160	 Made in U.S.A. 2" x 3" AFMSN236	 2" x 3" AFMSN234	 RUSH! 1-1/2" x 2" AFMSN603	 HOT 1-1/2" x 2" AFMSN601	

 EMPTY 6" x 6" AFMSL220	 DOT 49 CFR §172 4" x 4" AFMPC205	 CARGO AIRCRAFT ONLY FORBIDDEN IN PASSENGER AIRCRAFT 4-1/4" x 4-3/4" AFMSL219	 DOT 49 CFR §172 CONSUMER COMMODITY ORM-D 1-1/2" x 2-1/2" AFMSL223	 THIS END UP 5" x 3" AFMSL228	 THIS END UP 8" x 4" AFMPC126
---	--	---	---	--	--

Size	Price / Roll of 500
1-1/2" x 2", 1-1/2" x 2-1/2"	\$29.31
2" x 3", 4" x 3"	\$34.68
5" x 3", 4" x 4", 4-1/4" x 4-3/4"	\$39.99
6" x 4", 6" x 6"	\$43.57
2" x 8", 8" x 4"	\$71.73



- Helps meet D.O.T. (49 CFR part 172) and EPA (40 CFR part 262.31 - 32) regulations
- Use for labeling of substance containers for hazardous waste
- Durable labels are in English
- Matte surface for easy marking with pen or pencil
- 2.6-mil Adhesive-Poly label with permanent acrylic adhesive back and peel-off liner
- Stock available in package of 100

Size	Material	Price / Pkg. of 100
6" x 6"	Adhesive-Poly	\$47.91

California Codes of Regulations  
Title 22, Chapter 12, 6626.32 (b)



Stock # AFMHZW18EVC  
Custom # AFHZW18EVE  
1, 2, 3, 4, 5, 6, 7, 18

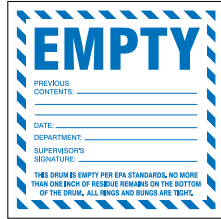

Stock # AFMHZW24EVC  
Custom # AFHZW24EVE  
13, 16, 19

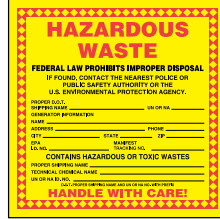

Stock # AFMHZW25EVC  
Custom # AFHZW25EVE  
1, 2, 3, 4, 5, 6, 7, 8,  
9, 18, 19, 20, 21

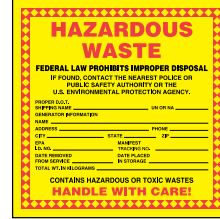

Stock # AFMHZW09EVC  
Custom # AFHZW09EVE  
1, 2, 3, 4, 5, 6, 7, 8,  
9, 10, 11, 12



Stock # AFMHZWCAEVC  
Custom # AFHZWCAEVE  
1, 3, 4, 5, 6, 7, 8, 9, 13, 14,  
15, 16, 18, 20, 21



Stock # AFMHZW20EVC  
Custom # AFHZW20EVE  
3, 4, 5, 6, 7, 8, 9, 14, 16



Stock # AFMHZW45EVC  
Custom # AFHZW45EVE  
3, 4, 5, 6, 7, 13

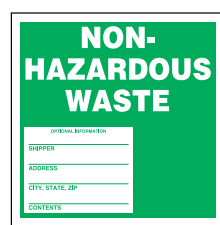

Stock # AFMHZW11EVC  
Custom # AFHZW11EVE  
3, 4, 5, 6, 7, 13



Stock # AFMHZW14EVC  
Custom # AFHZW14EVE  
3, 4, 5, 6, 7, 13



Stock # AFMHZW41EVC  
Custom # AFHZW41EVE  
3, 4, 5, 6, 7, 13



Stock # AFMHZW26EVC  
Custom # AFHZW26EVE  
4, 13, 17

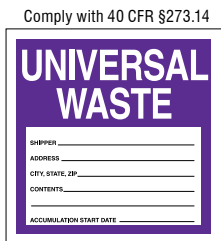

Stock # AFMHZW16EVC  
Custom # AFHZW16EVE  
3, 4, 5, 6, 7, 13, 16

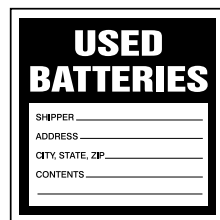

Stock # AFMHZW30EVC  
Custom # AFHZW30EVE  
3, 4, 5, 6, 7, 13

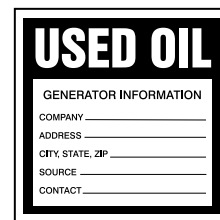

Stock # AFMHZW34EVC  
Custom # AFHZW34EVE  
3, 4, 5, 6, 7, 17



Stock # AFMHZW512EVC

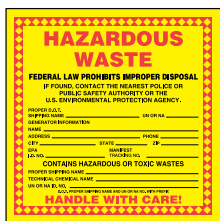

Stock # AFMHZW25EVC  
Custom # AFHZW25EVE  
1, 2, 3, 4, 5, 6, 7, 8,  
9, 18, 19, 20, 21

**Pre-Printed Custom Hazardous Waste Labels**  
Supply the information indicated by the Custom Field Codes associated with your label's part number (above). Call to order. Available each.

### Custom Field Codes Legend

- |                               |                               |
|-------------------------------|-------------------------------|
| 1- Proper DOT Shipping Name   | 12- Total Weight In Kilograms |
| 2- UN or NA                   | 13- Contents                  |
| 3- Name (Shipper)             | 14- EPA Waste Number          |
| 4- Address                    | 15- CA Waste Number           |
| 5- City                       | 16- Accumulation Start Date   |
| 6- State                      | 17- Contact Name              |
| 7- Zip Code                   | 18- Telephone Number          |
| 8- EPA ID Number              | 19- Department / Facility     |
| 9- Manifest Document Number   | 20- Technical Chemical Name   |
| 10- Date Removed From Service | 21- UN or NA No. with Prefix  |
| 11- Date Placed In Storage    |                               |

Size	Material	25 - 49	50 - 99	100 - 249	250+
6" x 6"	Adhesive-Poly	\$6.05	\$2.28	\$1.91	\$1.48

Don't see what you're looking for? Additional materials and sizes are available. Call us for details.

- Identify specific hazardous materials by applying to visible locations: Placards on vehicles and large containers; Labels on packages and small containers
- Specific color schemes, symbols, words, and numbers requirements identify the hazard

- Square-diamond format: Placard - 273 mm x 273 mm (10-3/4" x 10-3/4"); Label - 100 mm x 100 mm (4" x 4")
- Hazardous Material Regulation (HM-181 and HM-206) as specified by US-DOT 49 CFR, Parts 171 – 172 requires proper identification and classification for transport and shipping.

Hazard Class	Legend	Placard #	Label #
--------------	--------	-----------	---------

**Hazard Class 1**
**Explosives  
1.1**

1.1A	AFMPL11VP1	AFMSL11EV2
1.1B	AFMPL12VP1	AFMSL12EV2
1.1C	AFMPL13VP1	AFMSL13EV2
1.1D	AFMPL14VP1	AFMSL14EV2
1.1E	AFMPL15VP1	AFMSL15EV2
1.1F	AFMPL16VP1	AFMSL16EV2
1.1G	AFMPL17VP1	AFMSL17EV2
1.1J	AFMPL18VP1	AFMSL18EV2
1.1L	AFMPL19VP1	AFMSL19EV2

**Explosives  
1.2**

1.2B	AFMPL110VP1	AFMSL110EV2
1.2C	AFMPL111VP1	AFMSL111EV2
1.2D	AFMPL112VP1	AFMSL112EV2
1.2E	AFMPL113VP1	AFMSL113EV2
1.2F	AFMPL114VP1	AFMSL114EV2
1.2G	AFMPL115VP1	AFMSL115EV2
1.2H	AFMPL116VP1	AFMSL116EV2
1.2J	AFMPL117VP1	AFMSL117EV2
1.2K	AFMPL118VP1	AFMSL118EV2
1.2L	AFMPL119VP1	AFMSL119EV2

**Explosives  
1.3**

1.3C	AFMPL120VP1	AFMSL120EV2
1.3F	AFMPL121VP1	AFMSL121EV2
1.3G	AFMPL122VP1	AFMSL122EV2
1.3H	AFMPL123VP1	AFMSL123EV2
1.3J	AFMPL124VP1	AFMSL124EV2
1.3K	AFMPL125VP1	AFMSL125EV2
1.3L	AFMPL126VP1	AFMSL126EV2

**Explosives  
1.4**

1.4B	AFMPL127VP1	AFMSL127EV2
1.4C	AFMPL128VP1	AFMSL128EV2
1.4D	AFMPL129VP1	AFMSL129EV2
1.4E	AFMPL130VP1	AFMSL130EV2
1.4F	AFMPL131VP1	AFMSL131EV2
1.4G	AFMPL132VP1	AFMSL132EV2
1.4S	AFMPL133VP1	AFMSL133EV2

**Blasting Agents**

D	AFMPL134VP1	AFMSL134EV2
---	-------------	-------------

**Explosives**

N	AFMPL135VP1	AFMSL135EV2
---	-------------	-------------

**Hazard Class 2**

Flammable Gas	AFMPL202VP1	AFMSL202EV2
Non-Flammable Gas	AFMPL201VP1	AFMSL201EV2
Inhalation Hazard	AFMPL205VP1	AFMSL205EV2
Toxic Gas	AFMPL206VP1	AFMSL206EV2*
Oxygen	AFMPL204VP1	AFMSL204EV2

\*International use only

**Hazard Class 3**

Flammable Liquid	AFMPL301VP1	—
Combustible	AFMPL302VP1	—
Fuel Oil	AFMPL303VP1	—
Gasoline	AFMPL304VP1	—

**Placard Material –**

273 mm x 273 mm (10-3/4" x 10-3/4")

- Plastic - .055" thick polyethylene with impact, corrosion, and water resistance. Available each.

Material	Price / Each
Plastic	\$5.31

Hazard Class	Legend	Placard #	Label #
--------------	--------	-----------	---------

**Hazard Class 4**

Flammable Solid	AFMPL401VP1	AFMSL401EV2
Dangerous When Wet	AFMPL402VP1	AFMSL402EV2
Spontaneously Combustible	AFMPL403VP1	AFMSL403EV2

**Hazard Class 5**

Oxidizer, 5.1	AFMPL501VP1	AFMSL501EV2
Organic Peroxide, 5.2	AFMPL504VP1	AFMSL504EV2

**Hazard Class 6**



Poison	AFMPL601VP1	AFMSL601EV2
PG III	AFMPL604VP1	AFMSL607EV2
Inhalation Hazard	AFMPL603VP1	AFMSL605EV2
Toxic	AFMPL606VP1	AFMSL606EV2
Infectious Substance	—	AFMSL602EV2

**Hazard Class 7**

Radioactive	AFMPL701VP1	—
Radioactive I	—	AFMSL701EV2
Radioactive II	—	AFMSL702EV2
Radioactive III	—	AFMSL703EV2
Fissile	—	AFMSL704EV2

**Hazard Class 8**

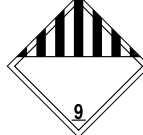
Corrosive	AFMPL801VP1	AFMSL801EV2
-----------	-------------	-------------

**Hazard Class 9**

Miscellaneous Dangerous Goods	AFMPL901VP1	AFMSL901EV2
-------------------------------	-------------	-------------

**For Mixed Loads**

Dangerous	AFMPLM01VP1	—
Hot	AFMPL905VP1	—

**Label Material –**

100 mm x 100 mm (4" x 4")

- Adhesive-Poly Sheet - flexible 2.6-mil vinyl poly is moisture-resistant with self-adhesive and liner back. Available in Roll of 250.

Material	Price / Roll
Adhesive-Poly	\$35.91

Don't see what you're looking for? Placards and labels are available in other materials. Call us for details.

Give workers immediate access to Safety Data Sheet documents stored in one convenient aluminum center.

Large, printed Center Boards identify the location of Right-To-Know information and make binders storing SDS documents accessible to employees. Hang the Center Boards near chemical storage areas or other central locations in the workplace. Boards have holes for wall mounting.



Kit AFZRS347

## Aluminum RTK - NFPA Basket Style

The eye-catching, multi-color Right-to-Know Center Board incorporates the Hazardous Material Classification Guide as a quick reference to the NFPA hazard classification codes.

The 18"H x 24"W board is .063" Aluminum with a coated wire basket bolted on to hold a single binder. Available each in English or Spanish. Center board kit is available with 1 1/2" binder, respective to the board's language.



Board AFZRS348

RTK - NFPA Basket Style	BOARD KIT		BOARD ONLY	
	Part #	Price / Kit	No.	Price / Each
English	AFZRS347	\$127.65	AFZRS348	\$117.45
Spanish	AFSHZRS347	\$127.65	AFSHZRS348	\$117.45

## Custom Basket Style Center Board

Basket Style Center Boards are available with your message and symbol and logo. To request a quote, refer to part number **ZRS355** and specify center board size, number of baskets on the board, message, design, color(s), and quantity. We will get back to you with a price and delivery.

## RTK Basket Style

Coated wire basket is bolted on to the lower portion of the aluminum center board to hold and store the SDS binder.\* The .063" Aluminum backboard measures:

**Single Basket style**  
20" x 15"

**Double Basket style**  
24" x 30"



Kit AFZRS326

Board AFZRS313



Kit AFZRS335

Board AFZRS316

\*Boards and Binders are available in English and Bilingual versions. Single boards include (1) 1 1/2" SDS binder, and double boards include (2) 1 1/2" binders.

RTK - Basket Style	BOARD KIT		BOARD ONLY	
	Part #	Price / Kit	Part #	Price / Each
Single Basket, English	AFZRS326	\$86.25	AFZRS313	\$71.48
Single Basket, Bilingual	AFSBZRS326	\$86.25	AFSBZRS313	\$71.48
Double Basket, English	AFZRS335	\$181.93	AFZRS316	\$153.39
Double Basket, Bilingual	AFSBZRS335	\$181.93	AFSBZRS316	\$153.39



## Pocket Style Centers



Kit AFSBZRS729



Kit AFZRS730



Kit AFZRS729  
Board AFZRS708

Sturdy all-aluminum center board has a lower pocket to hold and store the SDS binder and training booklets. Pocket is welded on for added strength. The .063" thick aluminum has scratch-resistant, powder-coated finish and 30"H x 24"W sign. The pocket extends out 4 1/8"D with inside dimensions 5 7/8"H x 23 1/4"W x 4"D and two dividers to separate the binder and booklets.

Center board kit is available with 1 1/2" SDS binder and 10 training booklets.

### Pocket Style Center

Board Kit  
Board Only

### Price / Each

\$181.31  
\$145.13

### Custom Pocket Style Center Boards

Blue Pocket Style Center Boards are available with your message and symbol or logo. To request a quote, refer to part number ZRS755 and specify message, design, color(s), and quantity. We will get back to you with a price and delivery.



## Safety Data Sheet Center Boards

Provide easy access to safety data sheets (SDS) in the workplace with center boards. Sturdy .063" aluminum backboard is 20"H x 15"W and printed with bold red diamond border for high visibility. PVC-coated steel wire rack holds 3-ring, 1 1/2" diameter binder (included). Four corner mounting holes are supplied for easy installation. Centers are sold as complete kits including the backboard, rack and binder as shown.

### Price / Kit

\$86.25



20" x 15" AFZRS407



20" x 15" AFZRS409



### Wire Binder Baskets

Baskets are designed to hold binders.  
Mount the basket near hazardous materials storage areas.

Coated white wire basket measures 9-1/2"H X 14"W X 6-3/4"D. Backside accommodates two mounting screws (hardware included) to support heavy binders.

Part #	Price / Each
AFZRS102	\$35.68



Binder sold separately.



### SDS Binders

Organize and store your SDS documents in plastic binders.

Front cover and spine have contrasting red letters. 3-ring binder has 36" metal security chain. Binders are available in white (WT) or yellow (YL) with red (RD) lettering.

Version	Ring Size	RD/YL #	RD/WT #	Price / Each
English	1 1/2"	ZRS641	ZRS632	\$24.36
English	2 1/2"	ZRS642	ZRS634	\$31.68
English	3"	ZRS643	ZRS640	\$33.93
Bilingual	1 1/2"	SBZRS641	SBZRS632	\$24.36
Bilingual	2 1/2"	SBZRS642	SBZRS634	\$31.68



### Projection™ Signs

- .10" thick high-impact plastic
- 3D signs, projecting 45° from the wall, provide optimum viewing from the front and sides
- 90D signs, projecting 90° from the wall, are viewed from either side

Style	Panel Size	Price / Each
3D	8" x 12"	\$20.22
90D	8" x 12"	\$18.26



3D – 8" x 18" x 9" (8" x 12" Panel) AFPSP768  
90D – 8" x 12" x 1 1/2" AFPSP452



3D – 8" x 18" x 9" (8" x 12" Panel) AFPSP764 AFPSP472  
90D – 8" x 12" x 1 1/2" AFPSP395 AFPSP776

### 180D Projection™ Signs

- .055" thick high-impact plastic
- 180D signs with repeated message can be viewed from front and sides
- Ships flat

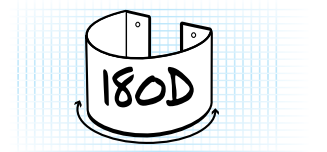

6" 12" AFPSJ142 AFPSJ372



6" 12" AFPSJ143 AFPSJ373

Panel Height	Installed Size	Price / Each
6"	6"H x 9"W x 5"D	\$11.71
12"	12"H x 16"W x 9.5"D	\$21.55

### Blank Metal Tags

Mark machines, equipment, pipes, and valves.

- Stamp, engrave, or write on blank tags
- Circle tag with 3/16" hole
- Brass is durable to withstand constant handling and ideal for tool checks, fittings, and valve identification
- Package of 25 or 100



Dia.	Part #	Price / Pkg. of 25	Part #	Price / Pkg. of 100
1"	AFTDB202	\$13.91	AFTDB101	\$43.59
1-1/4"	AFTDB204	\$28.05	AFTDB103	\$81.51
1-1/2"	AFTDB206	\$32.22	AFTDB106	\$98.56
2"	AFTDB208	\$41.05	AFTDB107	\$128.91

### Metal-Lite Tags

Tough, lightweight, poly-composite tags withstand abusive and outdoor environments.



- Resistant to long-term UV-exposure, chemicals, corrosion, and abrasion
- 3/16" thick, multi-ply tag with 1-1/2" diameter and 3/16" hole
- Thick, clear front is reverse, sub-surface engraved
- Color-filled and encapsulated by engineer-grade reflective sheet
- Pebble-textured poly back
- Sequentially numbered in series sets of 25

Series	Part #
1-25	AFTDL150
26-50	AFTDL151
51-75	AFTDL152
76-100	AFTDL153
101-125	AFTDL154
126-150	AFTDL156
151-175	AFTDL157
176-200	AFTDL158

Price / Set of 25
\$62.05

### Numbered Brass Tags

Numbered tags identify a wide variety of applications – including valves, keys, and tool checks.

- 18-gauge (.040") brass
- 1-1/2" diameter with 3/16" hole
- Sequentially numbered in series sets of 25

Price / Set of 25
\$64.14

Series	Part #
1-25	AFTDN101
26-50	AFTDN103
51-75	AFTDN105
76-100	AFTDN107
101-125	AFTDN109
126-150	AFTDN111
151-175	AFTDN113
176-200	AFTDN115



### Blank Accu-Ply™ Tags

Various colors are ideal for on-the-spot coding and identification with permanent marker.

- .063" rigid, two-ply plastic with matte, non-glare surface
- Resistant to heat, and impacts, durable for outdoors
- Circle with 3/16" top hole
- Package of 25

Dia.	Black	Red	Yellow	White	Price / Pkg of 25
1"	AFTDG211BK	AFTDG211RD	AFTDG211YL	AFTDG211WT	\$24.91
1-1/2"	AFTDG213BK	AFTDG213RD	AFTDG213YL	AFTDG213WT	\$25.85
2"	AFTDG214BK	AFTDG214RD	AFTDG214YL	AFTDG214WT	\$28.28

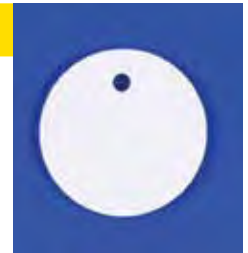

### Numbered Accu-Ply™ Engraved Tags

Use numbered tags as a coding system for a variety of items.

- .063" thick rigid plastic tags have a matte, non-glare surface
- Two-ply plastic construction with contrasting engraved layer
- Durable finish is tolerant to heat, impacts, and UV stable for outdoor use
- Circle tag with 1-1/2" diameter
- Sequentially numbered in series sets of 25

Price / Set of 25
\$58.82



Series	Black	Red	Yellow	White
1-25	AFTDG361BK	AFTDG361RD	AFTDG361YL	AFTDG361WT
26-50	AFTDG362BK	AFTDG362RD	AFTDG362YL	AFTDG362WT
51-75	AFTDG363BK	AFTDG363RD	AFTDG363YL	AFTDG363WT
76-100	AFTDG364BK	AFTDG364RD	AFTDG364YL	AFTDG364WT

Additional series sets available; contact us for details.

### CUSTOM ID TAGS MADE EASY!

#### Step 1: Material, Shape and Size by part number

Choose from a selection of metals and plastics.

#### Step 2: Letters, Numbers, or Legend

Specify as appropriate to size and application.

#### Step 3: Quantity

There are no set-up fees, and you can start with low numbers.

#### Step 4: Contact us today

We will provide you with a quote and delivery.



Don't see what you're looking for? ID tags are available in additional sizes, shapes and materials. Call us for details.



Mark contents and flow direction in pipes and piping systems with ready to go stock pipe markers.

A long list of chemicals and standard marking applications are offered in the stock selection. Pipe markers are available in size ranges and three main choices of pipe marking materials meet the needs of varied applications in industry.

The visible colors and bold lettering on the pipe makers are designed to meet or exceed ASME (ANSI) A13.1-2007 recommendations for size, color and visibility. Identify the contents in piping system throughout your facility with a comprehensive and standardized marking program.



### Choose The Right Stock Material

Select a material based upon your specific application to ensure that your pipe markers will last.

#### Self-Stick Vinyl Pipe Markers



Self-Stick Vinyl pipe marker displays one printed legend with detachable arrow for proper directional flow marking.

#### Material Features

- 4-mil flexible adhesive-backed vinyl with 2-mil, UV-resistant polyester film
- Detachable arrow\* included
- High-tack, acrylic adhesive back applies to a smooth, clean pipe surface
- Simply peel off the liner, align and press firmly into place for permanent application

#### Applications

- Service temperature range: -20° to 176°F
- Withstands various environmental elements

#### Cling-Tite Pipe Markers



Cling-Tite pipe markers wrap completely around the pipe and include a heavy-duty vinyl strip along the top leading edge that clings tightly to fasten the marker in place.

#### Material Features

- 7-mil polyester with a 2-mil polyester backing
- Subsurface printed legend with cleanable, glossy surface
- Legends are printed upright and upside-down– viewable from any direction – with directional arrows
- 360° wraparound pipe markers are easy to see from all angles
- Removable and reusable
- Ships and stores flat

#### Applications

- Service temperature range: -40° to 302°F for higher temperature pipes
- Resistant to scratches, abrasions and chemical splash
- Extremely durable for tough environments

#### Snap Tite™ Pipe Markers



Snap Tite™ pipe markers come pre-coiled and easily install by uncurling, placing on the pipe, releasing and “snapping” into place, encircling the entire pipe.

#### Material Features

- Heavy gauge 20-mil Rigid Vinyl plastic is lightweight, yet durable
- Legends are printed upright and upside-down– viewable from any direction – with directional arrows
- 360° wraparound pipe markers are easy to see from all angles
- No need to clean off the pipes to install – Snap Tite™ fits over pipes with dirty, greasy, or rough surfaces – even over insulation or other less than perfect surfaces
- Removable and reusable

#### Applications

- Service temperature range: -4° to 158°F
- Dirty, greasy and rough environments
- Tough industrial environments

Legend	Part #
<b>ACETONE</b>	AFRPK101
<b>ACETYLENE GAS</b>	AFRPK103
<b>ACETYLENE GAS</b>	AFRPK105
<b>ACID</b>	AFRPK107
<b>ACID</b>	AFRPK109
<b>ACID VENT</b>	AFRPK111
<b>ACID VENT</b>	AFRPK113
<b>ACID WASTE</b>	AFRPK115
<b>ACID WASTE</b>	AFRPK117
<b>AIR</b>	AFRPK119
<b>AIR</b>	AFRPK121
<b>AIR</b>	AFRPK123
<b>AIR RETURN</b>	AFRPK125
<b>AIR SUPPLY</b>	AFRPK127
<b>ALCOHOL</b>	AFRPK129
<b>ALUM</b>	AFRPK131
<b>ALUM</b>	AFRPK133
<b>AMMONIA</b>	AFRPK135
<b>AMMONIA</b>	AFRPK137
<b>ARGON</b>	AFRPK139
<b>ARGON</b>	AFRPK141
<b>ARGON</b>	AFRPK142
<b>ARGON</b>	AFRPK143
<b>ASBESTOS FREE</b>	AFRPK145
<b>ASBESTOS FREE INSULATION</b>	AFRPK147
<b>ASBESTOS INSULATION</b>	AFRPK149
<b>BACKWASH</b>	AFRPK151
<b>BLOWER AIR</b>	AFRPK153
<b>BOILER BLOW DOWN</b>	AFRPK157
<b>BOILER BLOW DOWN</b>	AFRPK159
<b>BOILER DRAIN</b>	AFRPK161
<b>BOILER DRAIN</b>	AFRPK163
<b>BOILER FEED</b>	AFRPK165
<b>BOILER FEED</b>	AFRPK167
<b>BOILER FEED WATER</b>	AFRPK169
<b>BOILER FEED WATER</b>	AFRPK171
<b>BREATHING AIR</b>	AFRPK173
<b>BRINE</b>	AFRPK175
<b>BRINE</b>	AFRPK177
<b>CARBON DIOXIDE</b>	AFRPK179
<b>CARBON DIOXIDE</b>	AFRPK181
<b>CAUSTIC</b>	AFRPK183
<b>CAUSTIC</b>	AFRPK185
<b>CAUSTIC SODA</b>	AFRPK187
<b>CAUSTIC SODA</b>	AFRPK189
<b>CHEMICAL</b>	AFRPK191
<b>CHEMICAL</b>	AFRPK193
<b>CHEMICAL FEED</b>	AFRPK195
<b>CHEMICAL FEED</b>	AFRPK197
<b>CHILLED WATER</b>	AFRPK199

Legend	Part #
<b>CHILLED WATER RETURN</b>	AFRPK201
<b>CHILLED WATER SUPPLY</b>	AFRPK203
<b>CHLORINE</b>	AFRPK205
<b>CHLORINE</b>	AFRPK207
<b>CIRCULATING WATER</b>	AFRPK209
<b>CITY GAS</b>	AFRPK211
<b>CITY GAS</b>	AFRPK213
<b>CITY WATER</b>	AFRPK215
<b>COLD SUPPLY</b>	AFRPK216
<b>COLD WATER</b>	AFRPK217
<b>COLD WATER DRAIN</b>	AFRPK219
<b>COLD WATER RETURN</b>	AFRPK221
<b>COLD WATER SUPPLY</b>	AFRPK223
<b>COMPRESSED AIR</b>	AFRPK225
<b>COMPRESSED AIR</b>	AFRPK226
<b>COMPRESSED AIR</b>	AFRPK227
<b>CONDENSATE</b>	AFRPK229
<b>CONDENSATE</b>	AFRPK231
<b>CONDENSATE DRAIN</b>	AFRPK233
<b>CONDENSATE DRAIN</b>	AFRPK234
<b>CONDENSATE PUMP DISCHARGE</b>	AFRPK235
<b>CONDENSATE PUMP DISCHARGE</b>	AFRPK236
<b>CONDENSATE RETURN</b>	AFRPK237
<b>CONDENSATE SUPPLY</b>	AFRPK239
<b>CONDENSER WATER</b>	AFRPK241
<b>CONDENSER WATER RETURN</b>	AFRPK243
<b>CONDENSER WATER SUPPLY</b>	AFRPK245
<b>COOLING WATER</b>	AFRPK247
<b>COOLING WATER RETURN</b>	AFRPK249
<b>COOLING WATER SUPPLY</b>	AFRPK251
<b>DEIONIZED WATER</b>	AFRPK253
<b>DEIONIZED WATER SUPPLY</b>	AFRPK257
<b>DIESEL FUEL</b>	AFRPK258
<b>DIESEL OIL</b>	AFRPK259
<b>DIESEL WASTE OIL</b>	AFRPK261
<b>DIESEL WASTE OIL</b>	AFRPK263
<b>DISCHARGE</b>	AFRPK265
<b>DISTILLED WATER</b>	AFRPK267
<b>DOMESTIC</b>	AFRPK269
<b>DOMESTIC COLD WATER</b>	AFRPK271
<b>DOMESTIC COLD WATER RETURN</b>	AFRPK273
<b>DOMESTIC COLD WATER SUPPLY</b>	AFRPK275
<b>DOMESTIC HOT WATER</b>	AFRPK277
<b>DOMESTIC HOT WATER</b>	AFRPK279
<b>DOMESTIC HOT WATER RECIRCULATION</b>	AFRPK281
<b>DOMESTIC HOT WATER RECIRCULATION</b>	AFRPK283
<b>DOMESTIC HOT WATER RETURN</b>	AFRPK285
<b>DOMESTIC HOT WATER RETURN</b>	AFRPK287
<b>DOMESTIC HOT WATER SUPPLY</b>	AFRPK289
<b>DOMESTIC HOT WATER SUPPLY</b>	AFRPK291

Legend	Part #
<b>DRAIN</b>	AFRPK293
<b>DRAIN</b>	AFRPK295
<b>DRAIN WATER</b>	AFRPK297
<b>DRINKING WATER</b>	AFRPK299
<b>EFFLUENT</b>	AFRPK301
<b>ELECTRIC TRACED</b>	AFRPK303
<b>ELECTRIC TRACED</b>	AFRPK305
<b>EXHAUST</b>	AFRPK307
<b>EXHAUST PIPE</b>	AFRPK308
<b>EXHAUST AIR</b>	AFRPK309
<b>EXHAUST PIPE</b>	AFRPK310
<b>FEED</b>	AFRPK311
<b>FEED</b>	AFRPK313
<b>FILTERED WATER</b>	AFRPK315
<b>FILTRATE</b>	AFRPK317
<b>FIRE AUTO SPRINKLER</b>	AFRPK319
<b>FIRE MAIN</b>	AFRPK321
<b>FIRE PROTECTION WATER</b>	AFRPK323
<b>FIRE SPRINKLER</b>	AFRPK324
<b>FIRE SPRINKLER WATER</b>	AFRPK325
<b>FIRE WATER SYSTEM</b>	AFRPK326
<b>FREON</b>	AFRPK327
<b>FREON</b>	AFRPK329
<b>FRESH WATER</b>	AFRPK331
<b>FUEL GAS</b>	AFRPK333
<b>FUEL GAS</b>	AFRPK335
<b>FUEL OIL</b>	AFRPK337
<b>FUEL OIL RETURN</b>	AFRPK339
<b>FUEL OIL SUPPLY</b>	AFRPK341
<b>FUEL OIL VENT</b>	AFRPK343
<b>GAS</b>	AFRPK345
<b>GAS</b>	AFRPK347
<b>GAS</b>	AFRPK349
<b>GASOLINE</b>	AFRPK351
<b>GASOLINE</b>	AFRPK353
<b>GLYCOL</b>	AFRPK357
<b>GLYCOL</b>	AFRPK359
<b>GLYCOL</b>	AFRPK361
<b>GLYCOL RETURN</b>	AFRPK363
<b>GLYCOL RETURN</b>	AFRPK365
<b>GLYCOL RETURN</b>	AFRPK367
<b>GLYCOL SUPPLY</b>	AFRPK369
<b>GLYCOL SUPPLY</b>	AFRPK371
<b>GLYCOL SUPPLY</b>	AFRPK373
<b>HALON</b>	AFRPK375
<b>HEATING</b>	AFRPK377
<b>HEATING HOT WATER RETURN</b>	AFRPK379
<b>HEATING HOT WATER RETURN</b>	AFRPK381
<b>HEATING HOT WATER SUPPLY</b>	AFRPK383
<b>HEATING HOT WATER SUPPLY</b>	AFRPK385

Legend	Part #
<b>HEATING RETURN</b>	AFRPK387
<b>HEATING SUPPLY</b>	AFRPK389
<b>HEATING WATER RETURN</b>	AFRPK391
<b>HEATING WATER SUPPLY</b>	AFRPK393
<b>HEATING WATER SUPPLY</b>	AFRPK395
<b>HIGH PRESSURE AIR</b>	AFRPK397
<b>HIGH PRESSURE AIR</b>	AFRPK399
<b>HIGH PRESSURE CONDENSATE</b>	AFRPK401
<b>HIGH PRESSURE GAS</b>	AFRPK403
<b>HIGH PRESSURE GAS</b>	AFRPK405
<b>HIGH PRESSURE HOT WATER</b>	AFRPK407
<b>HIGH PRESSURE HOT WATER</b>	AFRPK409
<b>HIGH PRESSURE NITROGEN</b>	AFRPK411
<b>HIGH PRESSURE STEAM</b>	AFRPK413
<b>HIGH PRESSURE WATER</b>	AFRPK415
<b>HIGH PRESSURE WATER</b>	AFRPK417
<b>HIGH PRESSURE NATURAL GAS</b>	AFRPK419
<b>HOT</b>	AFRPK421
<b>HOT WATER</b>	AFRPK423
<b>HOT WATER</b>	AFRPK425
<b>HOT WATER RETURN</b>	AFRPK427
<b>HOT WATER RETURN</b>	AFRPK429
<b>HOT WATER SUPPLY</b>	AFRPK431
<b>HOT WATER SUPPLY</b>	AFRPK433
<b>HYDRAULIC FLUID</b>	AFRPK435
<b>HYDRAULIC FLUID</b>	AFRPK437
<b>HYDRAULIC LINE</b>	AFRPK439
<b>HYDRAULIC LINE</b>	AFRPK441
<b>HYDRAULIC OIL</b>	AFRPK443
<b>HYDRAULIC OIL</b>	AFRPK445
<b>HYDRAULIC SUPPLY</b>	AFRPK447
<b>HYDROCHLORIC ACID</b>	AFRPK449
<b>HYDROCHLORIC ACID</b>	AFRPK451
<b>HYDROGEN</b>	AFRPK453
<b>HYDROGEN</b>	AFRPK457
<b>HYDROGEN PEROXIDE</b>	AFRPK459
<b>HYDROGEN PEROXIDE</b>	AFRPK461
<b>INDUSTRIAL WATER</b>	AFRPK463
<b>INERT GAS</b>	AFRPK465
<b>INERT GAS</b>	AFRPK467
<b>INSTRUMENT AIR</b>	AFRPK469
<b>INSTRUMENT AIR</b>	AFRPK471
<b>KEROSENE</b>	AFRPK473
<b>LAB VACUUM</b>	AFRPK475
<b>LAB VENT</b>	AFRPK477
<b>LAB WASTE</b>	AFRPK479
<b>LIQUID NITROGEN</b>	AFRPK481
<b>LOW PRESSURE</b>	AFRPK482
<b>LOW PRESSURE AIR</b>	AFRPK483
<b>LOW PRESSURE CONDENSATE</b>	AFRPK485



Legend	Part #
LOW PRESSURE GAS	AFRPK487
LOW PRESSURE GAS	AFRPK489
LOW PRESSURE NATURAL GAS	AFRPK491
LOW PRESSURE NATURAL GAS	AFRPK493
LOW PRESSURE NITROGEN	AFRPK495
LOW PRESSURE NITROGEN	AFRPK497
LOW PRESSURE STEAM	AFRPK499
LOW PRESSURE WATER	AFRPK501
LUBE OIL	AFRPK503
MAKE-UP WATER	AFRPK505
MEDICAL AIR	AFRPK507
MEDICAL VACUUM	AFRPK509
MEDIUM PRESSURE CONDENSATE	AFRPK511
MEDIUM PRESSURE STEAM	AFRPK513
MED-PRESSURE STEAM	AFRPK515
MILL AIR	AFRPK517
MILL WATER	AFRPK519
MIXED GAS	AFRPK521
NATURAL GAS	AFRPK523
NATURAL GAS	AFRPK525
NITRIC ACID	AFRPK527
NITRIC ACID	AFRPK529
NITROGEN	AFRPK531
NITROGEN	AFRPK533
NITROUS OXIDE	AFRPK535
NITROUS OXIDE	AFRPK537
NITROUS OXIDE	AFRPK539
NON-POTABLE WATER	AFRPK541
OIL	AFRPK543
OIL SUPPLY	AFRPK544
OUTSIDE AIR	AFRPK545
OVERFLOW	AFRPK547
OXYGEN	AFRPK549
OXYGEN	AFRPK551
OXYGEN	AFRPK553
OXYGEN	AFRPK557
PEROXIDE	AFRPK559
PEROXIDE	AFRPK561
PLANT AIR	AFRPK563
PLANT WATER	AFRPK565

Legend	Part #
PLUMBING VENT	AFRPK567
POLYMER	AFRPK569
POLYMER SOLUTION	AFRPK571
POTABLE	AFRPK573
POTABLE WATER	AFRPK575
POTABLE WATER	AFRPK576
PROCESS WATER	AFRPK577
PROCESS WATER	AFRPK579
PROCESS WATER RETURN	AFRPK581
PROCESS WATER SUPPLY	AFRPK583
PROPANE GAS	AFRPK585
PROPANE GAS	AFRPK587
PULP	AFRPK589
PUMP	AFRPK591
PUMPED CONDENSATE	AFRPK593
RAINWATER	AFRPK595
RAINWATER DRAIN	AFRPK596
RAW WATER	AFRPK597
RECIRCULATED WATER	AFRPK771
RECIRCULATED WATER	AFRPK773
REFRIGERANT LIQUID	AFRPK599
REFRIGERANT SUCTION	AFRPK601
REFRIGERATED LIQUID	AFRPK603
REFRIGERATED SUCTION	AFRPK605
REFRIGERATED WATER RETURN	AFRPK779
REFRIGERATION	AFRPK607
RETURN	AFRPK609
RETURN	AFRPK611
RETURN	AFRPK613
RETURN	AFRPK615
ROOF DRAIN	AFRPK617
SALT WATER	AFRPK619
SANITARY DRAIN	AFRPK621
SANITARY SEWER	AFRPK623
SANITARY VENT	AFRPK625
SANITARY WASTE	AFRPK627
SEAL WATER	AFRPK629
SERVICE AIR	AFRPK631
SERVICE WATER	AFRPK633
SEWAGE	AFRPK635

Legend	Part #
SEWER	AFRPK637
SLUDGE	AFRPK639
SOAP	AFRPK641
SODIUM HYDROXIDE	AFRPK643
SODIUM HYDROXIDE	AFRPK645
SODIUM HYPOCHLORITE	AFRPK647
SODIUM HYPOCHLORITE	AFRPK649
SOFT WATER	AFRPK651
SOLVENT	AFRPK653
SPENT ACID	AFRPK657
SPENT ACID	AFRPK659
SPRINKLER	AFRPK661
SPRINKLER FIRE	AFRPK663
SPRINKLER WATER	AFRPK665
STEAM	AFRPK667
STEAM RETURN	AFRPK669
STEAM SUPPLY	AFRPK671
STORM DRAIN	AFRPK673
STORM SEWER	AFRPK675
STORM WATER	AFRPK677
SULFUR DIOXIDE	AFRPK679
SULFUR DIOXIDE	AFRPK681
SULFURIC ACID	AFRPK683
SULFURIC ACID	AFRPK685
SUMP PUMP DISCHARGE	AFRPK687
SUPPLY	AFRPK689
SUPPLY	AFRPK691
SUPPLY	AFRPK693
TANK DRAIN	AFRPK695
TEMPERED WATER	AFRPK697
TEMPERED WATER	AFRPK699
TOLUENE	AFRPK701
TOLUENE	AFRPK703
TOWER WATER	AFRPK705
TOWER WATER RETURN	AFRPK707
TOWER WATER SUPPLY	AFRPK709
TREATED WATER	AFRPK711
UTILITY WATER	AFRPK713
UTILITY WATER	AFRPK715
VACUUM	AFRPK717



Legend	Part #
VACUUM	AFRPK719
VENT	AFRPK721
VENT	AFRPK723
VENT	AFRPK724
WARM WATER	AFRPK725
WASTE	AFRPK727
WASTE WATER	AFRPK729
WASTE WATER	AFRPK731
WATER	AFRPK733
WATER	AFRPK735
WELL WATER	AFRPK737
WHITE LIQUOR	AFRPK739
WHITE LIQUOR	AFRPK741
WHITE LIQUOR	AFRPK743
WHITE LIQUOR	AFRPK745
WHITE LIQUOR	AFRPK747
WHITE LIQUOR	AFRPK749
WHITE LIQUOR	AFRPK751
WHITE LIQUOR	AFRPK753
WHITE LIQUOR	AFRPK757
WHITE LIQUOR	AFRPK759
WHITE LIQUOR	AFRPK761
WHITE LIQUOR	AFRPK763
WHITE LIQUOR	AFRPK765
WHITE LIQUOR	AFRPK767
WHITE LIQUOR	AFRPK769

### How to Order Pipe Markers:

Find Legend: **ACETONE** AFRPK101

Select Material and Size Code: SSA – Self-Stick, 3/4" to 1 1/4"

Add Code to Legend No: AFRPK101SSA

#### SELF-STICK

Size Code	Pipe Diameter	Marker Size	Price / Each
SSA	3/4" to 1-1/4"	1" x 8"	\$1.97
SSB	1-1/2" to 2"	1-1/2" x 8"	\$2.08
SSD	2-1/2" to 6"	2-1/2" x 12"	\$2.53
SSH	8" to 10"	4" x 24"	\$6.39

#### CLING-TITE

Size Code	Pipe Diameter	Marker Size	Price / Each
CTA	3/4" to 1 1/4"	6" x 8"	\$3.95
CTB	1 1/2" to 2"	9" x 8"	\$5.22
CTC	2 1/4" to 3"	14" x 12"	\$9.68
CTE	3 1/4" to 5"	19" x 12**	\$10.71
CTF	5 1/4" to 6"	25" x 12**	\$11.19

#### SNAP TITE™

Size Code	Pipe Diameter	Marker Size	Price / Each
STA	3/4" to 1-1/4"	6" x 8"	\$4.64
STB	1-1/2" to 2"	9" x 8"	\$6.13
STC	2-1/4" to 3"	14" x 12"	\$11.39
STE	3-1/4" to 5"	19" x 12**	\$12.60
STF	5-1/4" to 6"	25" x 12**	\$13.08

\*Size has self-adhesive leading edge for secure fit



## Color Banding Pipe Marking Tapes

Variety of colors are ideal for coding pipes.

- 5-mil tapes with self-adhesive back, no liner
- Service temperature range -20° to 140°F
- Available in 1", 2" and 3" widths
- 108-ft. rolls



Roll Size	Red	Black	White	Purple	Gray	Blue	Brown	Yellow	Orange	Green	Price / Roll
1" x 108-Ft.	AFPTM613RD	AFPTM613BK	AFPTM613WT	AFPTM613PR	AFPTM613GY	AFPTM613BU	AFPTM613BN	AFPTM613YL	AFPTM613OR	AFPTM613GN	\$6.37
2" x 108-Ft.	AFPTM623RD	AFPTM623BK	AFPTM623WT	AFPTM623PR	AFPTM623GY	AFPTM623BU	AFPTM623BN	AFPTM623YL	AFPTM623OR	AFPTM623GN	\$11.93
3" x 108-Ft.	AFPTM633RD	AFPTM633BK	AFPTM633WT	AFPTM633PR	AFPTM633GY	AFPTM633BU	AFPTM633BN	AFPTM633YL	AFPTM633OR	AFPTM633GN	\$17.31

## Directional Flow Arrow Tapes

Provide 360° visibility for flow direction, with repeated arrows on the tape's length.

- 6-mil self-adhesive vinyl
- Available in 1", 2" and 4" widths
- 54-ft. rolls
- Meets ASME A13.1, 3.1



Roll Size	Black / Orange	Black / Yellow	White / Green	White / Blue	White / Red	White / Brown	Price / Roll
1" x 54-Ft.	AFRAW252BKOR	AFRAW252BKYL	AFRAW252GNWT	AFRAW252BUWT	AFRAW252RDWT	AFRAW252WTBR	\$17.22
2" x 54-Ft.	AFRAW254BKOR	AFRAW254BKYL	AFRAW254GNWT	AFRAW254BUWT	AFRAW254RDWT	AFRAW254WTBR	\$23.55
4" x 54-Ft.	AFRAW258BKOR	AFRAW258BKYL	AFRAW258GNWT	AFRAW258BUWT	AFRAW258RDWT	AFRAW258WTBR	\$43.77

## CUSTOM PIPE MARKERS MADE EASY!

### Step 1: Material and Size by part number

Measure the pipe outside diameter, including insulation, to determine proper size.

### Step 2: Color Combination

Refer to the ASME color guide.

### Step 3: Legend

Specify your desired marker legend, and include directional flow arrows, if they apply.

### Step 4: Quantity

There are no set-up costs or minimums!

Black on Orange
Black on Yellow
White on Green
White on Blue
White on Red
White on Brown

ASME Colors



## Self-Stick Vinyl

- 4-mil flexible vinyl with 2-mil overlaminat
- UV resistant polyester film withstands elements
- High-tack, acrylic adhesive back and peel-off liner
- Directional flow arrow marker included
- Price per Each

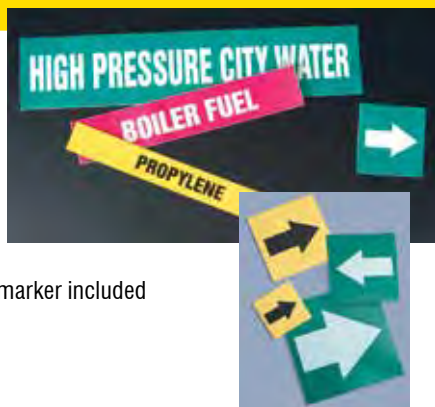

Fit Pipe Diameter	Marker Size	Part #	1 - 5	6 - 9	10 - 24	25+
3/4" to 1-1/4"	1" x 8"	AFRPS961	\$12.42	\$7.48	\$4.05	\$1.68
1-1/2" to 2"	1-1/2" x 8"	AFRPS963	\$13.08	\$7.85	\$4.28	\$1.76
2-1/2" to 6"	2-1/2" x 12"	AFRPS965	\$14.39	\$8.79	\$4.73	\$2.14
8" to 10"	4" x 24"	AFRPS967	\$19.33	\$12.77	\$7.53	\$5.45
Over 10"	4-1/2" x 32"	AFRPS969	\$22.91	\$16.33	\$11.93	\$9.25
Other Size		AFRPS955	Call for quote			

## Snap Tite™

- Pre-coiled design 'snaps' around to fit 360° over pipe
- 20-mil rigid vinyl with repeating message and directional arrow
- Ideal for irregular surfaces, insulated pipes, or where removal is necessary
- Not recommended for hot pipes
- Price per Each



Fit Pipe Diameter	Marker Size	Part #	1 - 5	6 - 9	10 - 24	25+
Up to 1/4"	2" x 4"	AFRPT920	\$17.88	\$13.11	\$8.42	\$5.93
Up to 1/2"	4" x 6"	AFRPT922	\$19.91	\$14.60	\$9.37	\$6.08
3/4" to 1-1/4"	6" x 8"	AFRPT924	\$22.13	\$16.19	\$10.37	\$6.76
1-1/2" to 2"	9" x 8"	AFRPT926	\$23.76	\$18.05	\$12.16	\$8.68
2-1/4" to 3"	14" x 12"	AFRPT928	\$28.76	\$22.85	\$17.45	\$13.68
3-1/4" to 5"	19" x 12"	AFRPT940*	\$32.45	\$24.14	\$22.13	\$16.16
5-1/4" to 6"	25" x 12"	AFRPT942*	\$35.65	\$27.31	\$23.13	\$18.68

\*Comes with self-adhesive leading edge

### Circuit Breaker Lockouts

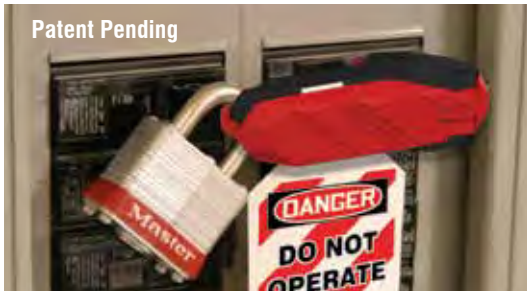

## STOPOUT®

Pump action of handle quickly secures lockouts to breaker switch.

This unique design allows for fastest lockout application time and quick and easy removal as well. The unit uses metal jaws for optimum secure grip. The Circuit Breaker Lockout is a visible safety red to call attention to the locked out switch.

- Fast secure application, quick-release tab
- Easily apply with just one hand if needed
- Octagon peg allows specially designed Tab Tags (sold separately) to be secured directly to the device
- Accommodates up to 9/32" dia. padlock shackles (sold separately)



Now Available to fit Single-, Double- and Triple- Pole Breakers

### Circuit Breaker Tab Tags

4 1/2" x 2 1/8", 15-mil RP-Plastic.

**Price / Pkg. of 25**

\$30.95



AFKDD166

Back

Item	Size	Part #	Price / Each
Single Pole	15/16"W x 3 1/3"L x 1 1/2"D	AFKDD160	\$14.55
Double Pole	1 3/4"W x 3 1/3"L x 1 1/2"D	AFKDD161	\$17.39
Triple Pole	2 1/2"W x 3 1/3"L x 1 1/2"D	AFKDD162	\$18.44

### Slide 'n Lock™



## STOPOUT®

Lockout large handle circuit breaker. Prevent and block the accidental push on flip style switches. Fits variety of wide lever switches or up to three in column standard circuit breakers.

- Installs easily with no drilling or binding with Mounting Rail for quick adhesion
- Visible red ABS plastic construction incorporates octagon shape to convey STOP
- Consists of three parts: Mounting Rail 5"L x 3/4"W x 1/4"D, Slide Set 2"L x 2"W x 1 3/8"D, Stop Bar 5"L x 1"W x 1"D
- Additional Mounting Rail available for use on multiple panels

Item	Part #	Price / Each
Slide 'n Lock	AFKDD280	\$18.30
Additional Mounting Rails, 5" L	AFKDD282	\$5.31

### Universal Blockout Wall Switch Cover



## STOPOUT®

Flip the switch, flip the lockout.

- Dual use lockout device works on both rocker/toggle and flat paddle switches
- Uses existing switch plate screws to attach the lockout device
- Fold-down, living hinge blocks access to screws, preventing removal
- Secure with standard padlock (sold separately); tag available separately
- Measures 4-1/2"H x 1-5/8"W x 7/8"D
- Unique design allowing the device to only be applied in the direction of the desired lock out position

Part #	Price / Each
AFKDD139	\$6.37

### Toggle-Switch Cover



## STOPOUT®

Prevent access to a toggle switch, yet still be able to see its position.

Quick and easy to install, tough lockout includes clear, industrial strength 3M™ VHB™ tape for secure adhesion\*.

Features:

- Used on toggles, buttons or knobs
- The top half can be removed and stored when not in use
- Clear polycarbonate maintains visibility of the switch position and doesn't disrupt existing decals, marking or messages
- 3 1/2" x 1 1/2" base which covers up to 3/4" x 1" switch area

\* For best adhesion, ideal bond time is 24 to 72 hours prior to lockout application

Part #	Price / Each
AFKDD142	\$22.55

### Ball Valve Lockout



Wingspan halves open and close

## STOPOUT®

Stop valves from being turned with unique gull-wing design ball valve lockout.

- Quickly and simply secure over any closed ball valve handle
- Secure with padlock (sold separately)
- Bright red, plastic device works with ball valve handles either perpendicular or parallel to pipe
- Includes red "Danger Locked Out" label

Fits Ball Valve	Overall Size	Part #	Price / Each
3/8" – 1 1/4"	3 1/8" x 4 1/2" x 4 1/2"	AFKDD442	\$15.84
1/2" – 2"	4 1/2" x 5 2/3" x 5 2/3"	AFKDD440	\$26.11

### Versatile Pneumatic End-Fittings Lockout



## STOPOUT®

Provides a lockout to your pneumatic equipment/source to maintain worker safety.

Secure and lockout several pneumatic devices at the same time, preventing connection to a compressed air line source. There are seven openings ranging from 9/32" – 1/2" diameter to fit most male and female pneumatic end fittings.

- Red octagon design reinforces lockout STOP status
- Clear top to see what is locked out
- Rugged polycarbonate halves with metal hinge close down on the end fittings
- Overall dimensions are 3 7/8" x 3 1/4" x 1 7/8"

Part #	Price / Each
AFKDD480	\$22.11

### Gate Valve Lockouts

## STOPOUT®

Prevent gate valve handles from being turned without authority.

- Hinged clamshell housing fully encloses the valve handle and prevents unauthorized access
- Tough plastic octagon features three shackle holes for group lockout\*
- Unique pry guard edge
- Included safety label has space to write in lockout information



Fits Valve Handle Dia.	Size	Part #	Price / Each
1" – 2-1/2"	3" x 1"	AFKFF470*	\$11.11
2-1/2" – 5"	5-1/2" x 2"	AFKDD471	\$16.91
5" – 6-1/2"	7" x 2"	AFKDD472	\$23.86
6-1/2" – 10"	10-1/2" x 3"	AFKDD473	\$29.53
10" – 13"	13" x 3-1/2"	AFKDD474	\$46.79

\*AFKDD470 has only one padlock shackle hole.

### Push Button Cover

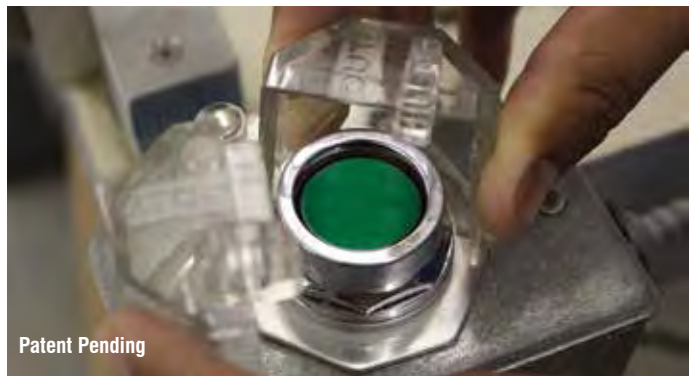

Patent Pending

## STOPOUT®

Prevent accidental activation of push button.

Two part lockout device: place aluminum metal ring underneath threaded ring nut and clear polycarbonate top with lip on bottom slips under the rim of the metal ring for a secure fit. (padlock sold separately).

- Semi-removable design allows for easy storage
- Tamper, impact resistant and extremely durable
- Available for 22.5 and 30mm buttons

Item	Part #	Price / Each
STOPOUT® Device with 22.5mm base	AFKDD219	\$25.19
STOPOUT® Device with 30mm base	AFKDD220	\$25.19
Additional 22.5mm metal ring only	AFKDD221	\$6.71
Additional 30mm metal ring only	AFKDD217	\$6.71



### Twist 'n Lock Cinch Lockout Hasp

## STOPOUT®

Easy-to-use cable and cinch lockout hasp solution.

- Polycarbonate, compact hasp comprised of two 3" dia. x 1 1/2" thick rotating halves with 6-ft. red plastic-coated steel cable
- Insert the cable through the devices to lock out; then pull the cable taut
- Short 15° turn of the hasp halves tightens and cinches the cable in place
- Pin pops up to hold the device in the secured position and lines up the four padlock holes
- Secure with lockout tag and padlocks (sold separately)



Part #	Price / Each
AFKDD637	\$23.31

### Disposable Padlock Seal

## STOPOUT®

Cost-saving, single-use lock device for operation-wide plant and facility lockout shutdown and turnaround.

- Loop and insert band end through padlock-style body; push band in to shorten and tighten the loop
- Molded teeth lock band in place inside the body and cannot reverse out
- Plastic shackle band can only be broken or cut for removal
- All-plastic body measures 2 1/2"H x 1 1/2"W x 7/8"D
- 7"L x 1/4"W long shackle band rated up to 100-lb pull strength



Part #	Price / Pkg. of 10
AFTLS202	\$27.71

### Look 'n Stop Compact Group Lock Box

## STOPOUT®

Small group lock box goes portable on the job – from the office to the production floor.

- Set on a desk, mount on the wall, or simply grab and go
- Slots in lid to insert and store locked out keys
- Unique twist-to-turn lid for secure close
- Inner pry-guard prevents tamper access
- Lid has two see through windows and carry handle
- Octagon shaped box in red conveys the STOP message
- 7 3/4" x 7 3/4" x 4" box is durable, impact-resistant plastic



Part #	Price / Each
AFKCC620	\$24.62

### Cinch Cable Lockout

## STOPOUT®

Universal spooling cable can lockout multiple devices at once.

- Contains internal cable spooling feature
- Quickly extend and loop 6-ft. cable through several devices
- Insert cable end back into device to "cinch" tight
- Pull the cable tight to automatically hold, secure with up to two padlocks (sold separately); tag available separately
- Durable plastic device measures 3-1/3" x 4" x 1"



Item	Part #	Price / Each
Cinch Lockout w/ 6-ft. Cable	AFKDD630	\$37.95
15-ft. Cable (separate)	AFKDD635	\$19.57

### Trailer-Lock Glad Hand Lockout

## STOPOUT®

Deter unauthorized drive-off of trailers by blocking access to the emergency brake airline.

- Easy-to-use, clam-style device measures 4"L x 3"W x 2"H and fits only one way
- Made of durable plastic with a zinc-coated steel pin for the hinge
- Attach to trailer's (red) line connection, and secure with your choice of padlock (sold separately) to control access.
- Hinges to completely cover the glad hand coupling point valve – fits standard valves

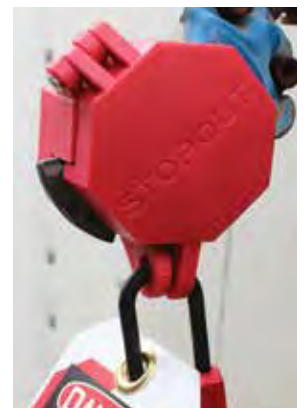

Part #	Price / Each
AFKDD477	\$19.22

### Look 'n Stop Group Lock Box

## STOPOUT®

Prevent access to keys of locked out devices until all workers have completed the project.

- Hang up to 16 keys inside with front slot to drop in additional keys
- Secure with up to 44 padlocks (sold separately) with hole for supervisor's padlock on left backside
- 13" x 13" x 3 1/2" impact-resistant plastic box with top carry handle
- Cover pry-guard edge provides security when using minimal padlocks
- Front cover slides to hinge open and close
- Two rear keyholes for wall mounting and flange foot to set on flat surface



Part #	Price / Each
AFKCC624	\$44.84

### StopPlug™ Lockout

## STOPOUT®

Prevent unauthorized, accidental plug-in of power cord.

- Insert plug, close down, and secure with padlock (sold separately)
- Tamper-proof, pry-guard edge design
- Multi-Plug lockout fits most 110, 220, 550, or 600 VAC plugs – measures 3"H x 3"W x 6"L.
- 110 Plug lockout fits most 110 VAC plugs – measures 2 1/4"H x 2 1/4"W x 3 1/2"L.



Style	Part #	Price / Each
Multi-Plug	AFKDD230	\$13.77
110 Plug	AFKDD225	\$12.08

### Aluma-Tag™ Hasps

## STOPOUT®

Lock out more equipment with the large reach hasp made to withstand the tough and abusive environment.

- Scissor-style hasp comprised of two high-strength .090" thick red anodized aluminum plates
- Accommodates up to six padlocks (sold separately)
- Crossover jaw ends prevent prying and tampering
- Get true 1 1/2" round reach with the full jaw opening
- Measures 6 3/4" x 3 1/8"
- Bold, contrasting red/white/black lockout hazard message labels on both sides — with space to write in necessary information
- Available each

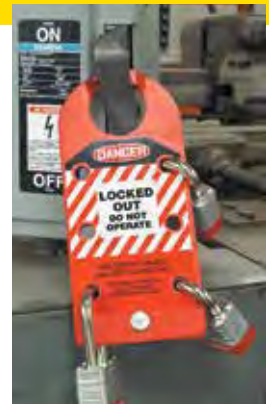

Price / Each

\$19.86

AFKDH642

AFKDH644

Back

### Lockout Tags

Comply with Lockout/Tagout standard 29 CFR § 1910.147.

- Spaces on tag to write in lockout information
- HS-Laminate is a heavy-duty, sealed composite plastic tag that is tear-proof, weather-proof, and chemical-resistant; 5-5/8" x 3-1/16" with 3/8" metal reinforced top hole
- Package of 25

Material Code	Material	Size	Price / Pkg. of 25
LTP	HS-Laminate	5-3/4" x 3-1/4"	\$57.88



AFMLT400LTP



AFMLT407LTP



AFMLT418LTP

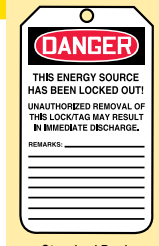

Standard Back

### Tag 'n Hang Hasp

## STOPOUT®

Change out, insert, and secure a lockout tab tag for each lockout situation.

- 5 1/4" x 3" hasp fits in the palm of the hand
- Lightweight, all-dielectric plastic design
- Stop-shaped octagon front panel contains changeable lockout Tab Tag (sold separately)

Easy to use:

- Insert lockout tag over the top hole inside the front panel
- Close down the 2 1/4" octagon panel to hold the tag in place
- Insert the open end of the 1/4" wide loop to lockout the device
- Hasp hangs by the 1 3/8" x 2 3/4" closed oval loop
- Secures with up to three padlocks (sold separately)

Part #	Price / Each
AFKDH115	\$8.33

### Tab Tags

4 1/2" x 2 1/8", 15-mil RP-Plastic.

Price / Pkg. of 25

\$30.95



AFKDD166



Back



Shown with Padlocks, Tab Tag, sold separately

### Standard Lockout Kit

## STOPOUT®

#### Kit includes:

- |   |   |
|---|---|
| <ul style="list-style-type: none"> <li>1 Lockout Box, Plastic, 18"L x 6 1/2"W x 4 3/4"H</li> <li>2 Lockout Scissor Hasps, 1" opening</li> <li>1 STOPOUT® Aluma-Tag™ Hasp, 1 1/2" opening</li> <li>3 Steel Padlocks (keyed differently), 3/4" shackle</li> </ul> | <ul style="list-style-type: none"> <li>50 Labels for Padlocks</li> <li>25 HS-Laminate Lockout Tags</li> <li>2 STOPOUT® Circuit Breaker Lockouts</li> <li>25 STOPOUT® Circuit Breaker Lockout Tab Tags</li> <li>1 STOPOUT® StopPlug™ Multi-Plug Lockout</li> </ul> |
|---|---|



Style	Part #	Price / Kit
Box Kit	AFKSK234	\$186.51
Box Only	AFKSB018	\$32.19

### Deluxe Plus Lockout Kit

## STOPOUT®

#### Kit includes:

- |  |  |
|--|--|
| <ul style="list-style-type: none"> <li>1 Lockout Box, Plastic, 19"L x 9 1/2"W x 9 1/2"H</li> <li>2 Lockout Scissor Hasps, 1" opening</li> <li>2 Lockout Scissor Hasps, 1 1/2" opening</li> <li>2 STOPOUT® Aluma-Tag™ Hasps, 1 1/2" opening</li> <li>6 Steel Padlocks (keyed differently), 3/4" shackle</li> <li>6 Steel Padlocks (keyed differently), 1 1/2" shackle</li> <li>100 Labels for Padlock</li> <li>50 HS-Laminate Lockout Tags</li> <li>2 STOPOUT® Circuit Breaker Lockouts</li> <li>25 STOPOUT® Circuit Breaker Lockout Tab Tags</li> <li>2 STOPOUT® Universal Wall Switch Lockouts</li> </ul> | <ul style="list-style-type: none"> <li>1 STOPOUT® StopPlug™ Multi-Plug Lockout</li> <li>1 STOPOUT® StopPlug™ 110 Plug Lockout</li> <li>1 AC Voltage Sensor</li> <li>2 STOPOUT® Ball Valve Lockout, 3/8" – 1 1/4" Valve</li> <li>2 STOPOUT® Ball Valve Lockout, 1 1/2" – 2" Valve</li> <li>2 STOPOUT® Gate Valve Lockout, 1" – 2 1/2" Handle</li> <li>2 STOPOUT® Gate Valve Lockout, 2 1/2" – 5" Handle</li> <li>1 Training Booklet</li> <li>1 Magnetic Label 3 1/2" x 5"; DANGER: EQUIPMENT LOCKED OUT, DO NOT REMOVE LOCKS</li> </ul> |
|--|--|



Style	Part #	Price / Kit
Box Kit	AFKSK347	\$613.00
Box Only	AFKSB021	\$49.71

### Aluminum Hanger Boards



AFKST404

Durable, .040" aluminum boards have aluminum pronged hooks to hang padlocks and lockout hasps. Thick molded, clear poly pocket measures 4 3/4"H x 3 5/8"W x 2"D to hold lockout tags. Designed for tough environments. Available in 6- and 12-padlock capacity sizes along with 1- and 2-pockets, respectively.

#### 6-Padlock Board

##### Kit contents:

- 6 Steel Padlocks, (keyed differently) 3/4" shackle
- 10 HS-Laminate Lockout Tags
- 10 Plastic Ties
- 1 Lockout Scissor Hasp, 1" opening
- 1 Lockout Scissor Hasp, 1 1/2" opening

#### 12-Padlock Board

##### Kit contents:

- 12 Steel Padlocks, (keyed differently) 3/4" shackle
- 50 HS-Laminate Lockout Tags - Locked Out Do Not Operate
- 50 Plastic Ties
- 1 Lockout Scissor Hasp, 1" opening
- 1 Lockout Scissor Hasp, 1 1/2" opening

Style	Size	Part #	Price / Each
6-Padlock Board Board w/Kit	14" x 14"	AFKST404	\$186.23
Board Only	14" x 14"	AFKST406	\$62.11
12-Padlock Board Board w/Kit	20" x 14"	AFKST410	\$375.83
Board Only	20" x 14"	AFKST412	\$71.86



**Steering Wheel Message Cover™**
**STOPOUT®**

Prevent the driving of a vehicle that is disabled or being worked on.

- Flexible, reinforced vinyl cover
- Slips over standard size steering wheels
- 3/8" metal grommeted hole at bottom accommodates 1-1/2" hasp with padlocks (sold separately) to secure cover to steering wheel



16" AFKDD714  
20" AFKDD725  
24" AFKDD736



16" AFKDD715  
20" AFKDD726  
24" AFKDD737



16" AFKDD719  
20" AFKDD724  
24" AFKDD733



16" AFKDD716  
20" AFKDD727  
24" AFKDD738

Size	Price / Each
16"	\$31.84
20"	\$41.93
24"	\$49.91

16"	AFKDD717
20"	AFKDD728
24"	AFKDD739

**Custom Steering Wheel Covers**

Write your message and sketch your symbol or logo (if necessary). Specify cover color — white or yellow, print color, and provide the quantity. Call, fax, or e-mail us your request with part number listed for a quote and delivery.

Size	Part #	1 - 5	6 - 9	10 - 24	25+
16"	AFKDD765	\$66.65	\$51.88	\$44.48	\$37.08
20"	AFKDD776	\$84.99	\$66.08	\$56.65	\$47.22
24"	AFKDD785	\$99.79	\$77.68	\$66.57	\$55.45
Other Sizes	AFKDD755	Call for quote			

**Lockout Procedure Station**

Lockout Procedure Station & Lockout Procedure Form shown. Available as Kit, Item AFKSS142.

Document, track, and provide easy access for your workers of lockout/tagout procedures in one convenient location.

The two-color, screened aluminum backboard measures 20"H x 15"W x .063" thick and has a PVC-coated steel wire rack to hold the binder. 3-ring, 1 1/2" binder (included) organizes your Lockout Procedure Forms - 25/pkg. (included). Record steps to perform proper lockout procedures. Energy Source & Isolation Forms allow you to quickly identify and list energy source type, location of lockout device, and means of lockout. Additional forms and binders available.



Lockout Safety Procedure Form shown. Item AFKSS144.



Energy Source & Isolation Form shown. Available separately, Item AFKSS151.

Item	UOM	Part #	Price / UOM
Station, Binder, Procedure Forms	Kit	AFKSS142	\$91.11
1 1/2" Binder	Each	AFKSS146	\$24.36
Additional Forms			
Lockout Safety Procedure	Pkg. of 25	AFKSS144	\$5.39
Energy Source & Isolation	Pkg. of 25	AFKSS151	\$5.39

Cross out open entryway to a Confined Space.

- Crossbuck design fits onto bolt pattern of vertical confined space entrances
- Attention-getting diagonal red-white stripes
- Center octagonal sign features color, layout, and confined space warning message as specified by OSHA/ANSI
- Adjustable crossbucks pivot flat for easy transport and storage
- Durable, .060" polycarbonate plastic crossbucks withstand initial impacts, scratches, and other industrial conditions
- Surface-printed stripes protected by laminate film
- 11-1/2" x 11-1/2" sign printed on .055" polyethylene plastic
- Each arm measures 6" x 42" with 1-1/2" x 9" slotted cutouts at ends to fit bolt pattern — fits 22" to 38" outside bolt-to-bolt\*



AFCXB633



AFCXB631



AFCXB635



AFSHCXB631



**Price / Each**

\$98.93

\* To verify proper fit of the Man-Way Cross™ Barrier for your entryway, measure the length across the entryway from bolt to bolt; then measure the bolt diameter.

**Custom Man-Way Cross™ Barrier Legends**  
Customize the legend to meet your company's need. Please contact us, and refer to part number AFCXB555 for a quote. Specify your desired OSHA heading, your desired legend, and quantity.



§ 1910.146 (e) (1) . . .the employer shall document the completion of measures required by preparing an entry permit... (3) The completed permit shall be made available at the time of entry to all authorized entrants, by posting it at the entry portal or by any other effective means...

Fill out confined space entry-related information in the spaces provided for documentation, recording requirements.

- Available in 3 distinct formatted styles of information required
- Best displayed in a Confined Space Permit Holder Board
- Pre-printed 8 1/2" x 11" paper sheets, 100 sheets/pad

Item	Part #	Price / Pad of 100
Checklist	AFCBS244	\$68.15
Entry Permit	AFCBS246	\$68.15
Sewer Entry Permit	AFCBS248	\$68.15



Permit Sheets - Checklist Shown

Customize Permits with your specific information. Contact us for a quote with part number AFCBS855; specify your quantity, layout and checklist requirements.

**Confined Space Permit Station**

Make permits accessible where they are needed - at the site.

- Mount the station at or near the job site
- Store blank permits for easy access to the workers
- 14" x 20" x .040" thick aluminum board with corner mounting holes
- Clear plastic holder with flip top lid allows storage of blank permits protected from the elements



Part #	Price / Each
AFCBS420	\$67.88

Permits Sold Separately

**Permit Holder Board**

Board communicates the Confined Space requirements and holds related entry permit sheet.

- Hang or set board near or at the entrance of confined space to be readily seen by all
- Features large OSHA sign message with clear acrylic pocket for 8 1/2" x 11" entry permit (available separately)
- Board is 12"H x 19"W x 1/8" thick plastic construction with corner mounting holes

Price / Each
\$64.31



AFCBS129

We will create one with your design in mind. Order AFCBS555 and provide us the following specifications - dimensions, message, color(s), and company logo, if required. We can provide a proof upon request.

Post traffic signs to safely control and regulate the flow of vehicles and pedestrians.

- Constructed of heavy-duty, .080" aluminum, rustproof to withstand weather conditions
- Reflective face for added bounce-back light visibility from headlights and other light sources
- Abrasion-resistant face is also UV-resistant to prevent fading for years of outdoor exposure
- Top and bottom center holes for post- or fence-mount installation

**Material Descriptions:**

**Engineer-Grade Prismatic (RA)** – Good choice for added visibility in low-light conditions. Type I

**High-Intensity Prismatic (HP)** – Better choice for greater visibility, 3X brighter than Engineer-Grade. Type III, IV, X

**DG High-Prism (DP)** – Best choice for wide angle visibility at 10X brighter than Engineer-Grade. Type IX



Mat'l  
RA AFFRR2185RA  
HP AFFRR2185HP  
24" x 18"  
RA AFFRR2245RA  
HP AFFRR2245HP



18" x 12"  
AFFRR21810RA  
AFFRR21810HP  
24" x 18"  
AFFRR22410RA  
AFFRR22410HP



18" x 12"  
AFFRR21815RA  
AFFRR21815HP  
24" x 18"  
AFFRR22415RA  
AFFRR22415HP



18" x 12"  
AFFRR21820RA  
AFFRR21820HP  
24" x 18"  
AFFRR22420RA  
AFFRR22420HP



18" x 12"  
AFFRR21825RA  
AFFRR21825HP  
24" x 18"  
AFFRR22425RA  
AFFRR22425HP



18" x 12"  
AFFRP116RA



Mat'l  
RA AFFRA227RA



18" x 12"  
AFFRA231RA



18" x 12"  
AFFRA117RA



18" x 12"  
AFFRP110RA



18" x 12"  
AFFRP114RA



18" x 12"  
AFFRP217RA



18" x 12"  
AFFRP218RA



Mat'l  
RA AFFRW427RA  
HP AFFRW427HP  
DP AFFRW427DP



24" x 24"  
AFFRW464RA  
AFFRW464HP  
AFFRW464DP



Mat'l  
RA AFMR1124  
HP AFFRR048  
DP AFFRR338



24" x 24"  
AFFRR424RA  
AFFRR424HP  
AFFRR424DP

Size	RA	HP	DP
18" x 12"	\$37.93	\$46.15	—
24" x 18"	\$75.80	\$92.19	—
24" x 24"	\$100.95	\$122.77	\$163.28

Size	RA	HP	DP	RA	HP	DP
24" x 24"	\$90.86	\$110.51	\$146.95	\$90.86	\$110.51	\$146.95
30" x 30"	\$125.68	\$152.84	\$203.31	\$125.68	\$152.84	\$203.31

**Sign Posts and Hardware**

- Posts available in 2 colors and 2 sizes\*
- 8-ft. post heavy weight – 2.00-lb./ft.
- 6-ft. post standard weight – 1.12-lb./ft.
- Hardware set (sold separately) contains 2 nuts, 2 bolts, and 4 washers

Length*	GREEN		GALVANIZED	
	Part #	Price / Each	Part #	Price / Each
6-Ft. (1.12-lb./ft.)	AFHSP106	\$23.43	AFHSP107	\$29.87
8-Ft. (2-lb./ft.)	AFHSP108	\$47.99	AFHSP109	\$59.51
				<b>Price / Set</b>
Hardware Set, 2 nuts, 2 bolts, 4 washers			AFHFN208	\$3.03

\*Other lengths also available. Contact us for details.



### Rail Signs



Mat'l  
RA  
HP  
DP

12" x 24"  
AFFRR737RA  
AFFRR737HP  
AFFRR737DP

R15-1  
2 pieces; 9" x 48" x 90"  
AFMR15RA  
AFMR15HP  
AFMR15DP

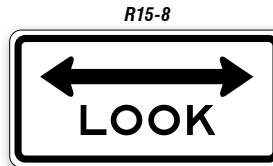

Mat'l  
RA  
HP  
DP

18" x 36"  
AFFRR747RA  
AFFRR747HP  
AFFRR747DP



24" x 18"  
AFFRR333RA  
AFFRR333HP  
AFFRR333DP



Mat'l  
RA  
HP  
DP

24" x 18"  
AFFRR331RA  
AFFRR331HP  
AFFRR331DP

30" x 24"  
AFMR88RA  
AFMR88HP  
AFMR88DP



18" x 18"  
AFFRR702RA  
AFFRR702HP  
AFFRR702DP

24" x 24"  
AFFRR703RA  
AFFRR703HP  
AFFRR703DP



36" x 24"  
AFFRR704RA  
AFFRR704HP  
AFFRR704DP



30" x 24"  
AFFRR471RA  
AFFRR471HP  
AFFRR471DP

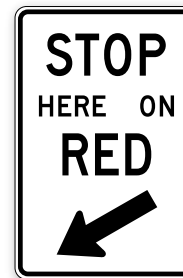

36" x 24"  
AFFRR468RA  
AFFRR468HP  
AFFRR468DP



30" x 24"  
AFFRR469RA  
AFFRR469HP  
AFFRR469DP



Mat'l  
RA  
HP  
DP

30" diameter  
AFMW1013030RA  
AFMW1013030HP  
AFMW1013030DP

36" diameter  
AFMW1013636RA  
AFMW1013636HP  
AFMW1013636DP



W10-1

24" x 24"  
AFFRW679RA  
AFFRW679HP  
AFFRW679DP

30" x 30"  
AFFRW680RA  
AFFRW680HP  
AFFRW680DP



W10-4

30" x 30" Track Right  
AFFRW473RA  
AFFRW473HP  
AFFRW473DP

30" x 30" Track Left  
AFFRW474RA  
AFFRW474HP  
AFFRW474DP

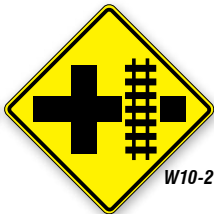

W10-2

30" x 30"  
AFFRW471RA  
AFFRW471HP  
AFFRW471DP

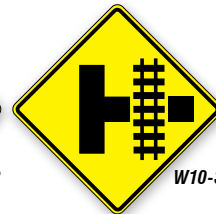

W10-3

30" x 30"  
AFFRW472RA  
AFFRW472HP  
AFFRW472DP

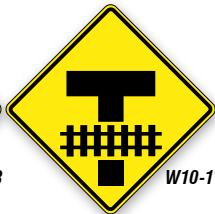

W10-11

30" x 30"  
AFFRW707RA  
AFFRW707HP  
AFFRW707DP

Size	RA	HP	DP
12" x 24"; 18" x 18"	\$63.24	\$76.91	\$102.31
18" x 36"	\$113.62	\$138.17	\$183.77
24" x 18"	\$75.80	\$92.19	\$122.59
24" x 24"	\$100.95	\$122.77	\$163.28
30" x 24"	\$121.51	\$147.71	\$196.46
30" x 30"; 30" dia.	\$139.66	\$169.84	\$225.91
36" x 24"	\$130.62	\$158.80	\$211.20
36" dia.	\$176.02	\$214.04	\$284.66
9" x 48" x 90"	\$139.66	\$169.84	\$225.91



### Custom Railroad Crossing Signals

Custom Railroad Crossing Signals are available. Specify signal style (one- or two-sided), controller and sensor settings, and desired accessories. Additional information may also be required. Refer to part number AFFSR555. We will get back to you with a quote.



TRUCK SHIPMENTS (LTL - Less than Truckload) We are committed to getting items only transportable by truck to you in excellent condition, and in a timely manner. We know that your business depends on speed and convenience. To assist in providing advance notice on items that MUST ship by truck, we have identified those items with a truck icon throughout this catalog. If you do not have a preferred LTL carrier, we will help determine the best carrier for your order. On occasion, large quantity orders may be more cost effective to ship via LTL carrier; in these instances, you will be notified prior to shipment. Truck shipments do not qualify for any special shipping promotions.

### Cone Top Warning Signs

Temporarily and quickly direct facility traffic.

- Slips into top of any traffic cone
- Rugged, 10" x 14" .060" plastic
- Same message both sides
- Weather- and fade-resistant

Price / Each

\$24.22



AFFBC752



AFFBC768



AFFBC776



AFFBC772



AFFBC754



AFFBC756



AFFBC748



AFFBC766



AFFBC758

Cone not included.

### Floor Marking Stencils

Mark your facility legibly and consistently with easily recognizable symbol and message.

- 20" x 20" design with 1.7" or greater high characters on 24" x 24" panel
- Durable, flexible 1/16" (.060") polyethylene plastic withstands rough handling
- Reusable, easy to clean

Price / Each

\$72.71



AFPM209



AFPM206



AFPM214



AFPM208



AFPM211



AFPM225



AFPM205



AFPM229



AFPM203



AFPM223

#### Custom Floor Marking Stencils

Custom stencils are available with any message, design, and logo. Stencils are made from tough 1/16" (.060") polyethylene material. To receive a quote, refer to part number AFFMS355 and provide your wording, idea or design, image, character sizes (minimum height 1"), and quantity.

For smaller, message-only stencils, refer to part number AFFMS455. Made from .010" Mylar® plastic with characters as small as 1/4" high.

### Skid-Gard™ Floor Signs

- High-traction, anti-skid, clear grit surface
- 6" x 24" sub-surface printed vinyl floor signs
- High-tack, acrylic adhesive back with peel-off liner

Price / Each

\$24.44



AFPSD107



AFPSD101



AFPSD606



AFPSD637



AFPSD631



AFPSD620



AFPSD650



AFPSD622



AFPSD603



AFPSD404



- Self-Adhesive floor sign for walkways, entrances and work areas
- Non-slip durable vinyl surface with pebble texture to withstand heavy traffic areas
- Sub-surface printed and overlaminated by protective layer
- Strong permanent acrylic adhesive back with peel-off liner
- Adheres firmly to smooth, clean, dry surface
- Available each

Style	Size	Price / Each
Round-Style	8"	\$17.99
Round-Style	17"	\$32.31
Step-Style	6" x 24"	\$21.45
Mat-Style	20" x 14"	\$43.51

**Round-style**



8" AFMFS0308  
17" AFMFS0317



8" AFMFS842  
17" AFMFS731



8" AFMFS1708  
17" AFMFS1717



8" AFMFS311  
17" AFMFS200



8" AFMFS1808  
17" AFMFS1817



8" AFMFS1408  
17" AFMFS1417



8" AFMFS837  
17" AFMFS724



8" AFMFS1108  
17" AFMFS1117



8" AFMFS819  
17" AFMFS716



8" AFMFS840  
17" AFMFS729



8" AFMFS816  
17" AFMFS725



8" AFMFS2608  
17" AFMFS2617



8" AFMFS316  
17" AFMFS205



8" AFMFS824  
17" AFMFS723



8" AFMFS2208  
17" AFMFS2217



8" AFMFS2808  
17" AFMFS2817



8" AFMFS829  
17" AFMFS706



8" AFMFS0708  
17" AFMFS0717

**Step-style**



6" x 24" AFPSR240



6" x 24" AFPSR242



6" x 24" AFPSR244



6" x 24" AFPSR246



6" x 24" AFPSR248



6" x 24" AFPSR260



6" x 24" AFPSR262



6" x 24" AFPSR264



6" x 24" AFPSR266



6" x 24" AFPSR268

**Mat-style**



20" x 14" AFPSR640



20" x 14" AFPSR620



20" x 14" AFPSR624



20" x 14" AFPSR670



20" x 14" AFPSR633



20" x 14" AFPSR636



20" x 14" AFPSR684



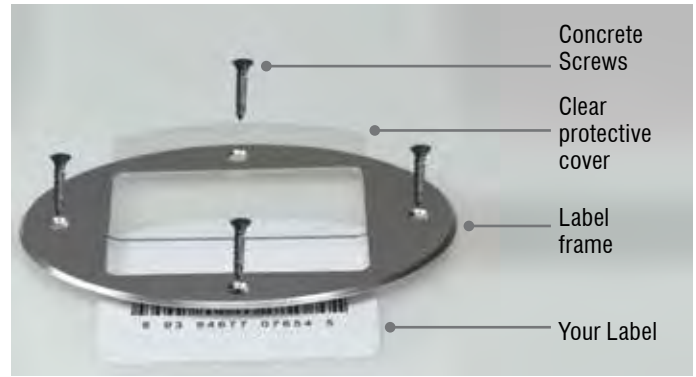

Mount and protect identification labels on the floor. Place and protect message, information, barcode, and other identification on the floor contained in a sturdy frame system. The metal frame mounts directly to the floor, containing a clear protective cover to protect your label (not included) underneath. Available in two sizes.

**Small size:**

- 8 1/2" x 5 1/2" x 1/8" all-aluminum oval frame
- 3 1/2" x 5" x .063" clear visible protective polycarbonate cover

**Large size:**

- 12" x 7 1/2" x 1/8" all-aluminum oval frame
- 5" x 7" x .063" clear visible protective polycarbonate cover

Frame features beveled edges to prevent abuse and damage from rollover of pallet jacks and forklift vehicles, as well as slide-over from pallets. Four concrete screws (included) secure frame to floor and prevent removal of the clear insert and label.

The frame's smooth underside can also be installed to floors using adhesive (not included).

UOM	Small Part #	Price / UOM	Large Part #	Price / UOM
Each	AFDTF801	\$27.94	AFDTF811	\$29.96
Pkg. of 10	AFDTF803	\$271.00 (\$27.10 ea)	AFDTF813	\$290.60 (\$29.06 ea)
Pkg. of 25	AFDTF805	\$657.25 (\$26.29 ea)	AFDTF815	\$704.25 (\$28.17 ea)
Pkg. of 50	AFDTF807	\$1275.00 (\$25.50 ea)	AFDTF817	\$1367.00 (\$27.34 ea)
Pkg. of 100	AFDTF809	\$2474.00 (\$24.74 ea)	AFDTF819	\$2652.00 (\$26.52 ea)

**Custom Floor-ID™ Label Frame System**

We can print an image on the underside of the cover to permanently show through the clear insert. Create and provide us your image, message, barcode, and any other identification or information - including logos, symbols, and full color picture. We put your idea together. Proof is available (upon request).

Size	Part #	1 - 5	6 - 9	10 - 24	25 - 49	50 - 99	100+
Small	AFDTF555	\$39.82	\$38.08	\$33.97	\$30.14	\$28.36	\$25.33
Large	AFDTF655	\$46.45	\$41.34	\$36.85	\$34.22	\$28.71	\$27.60

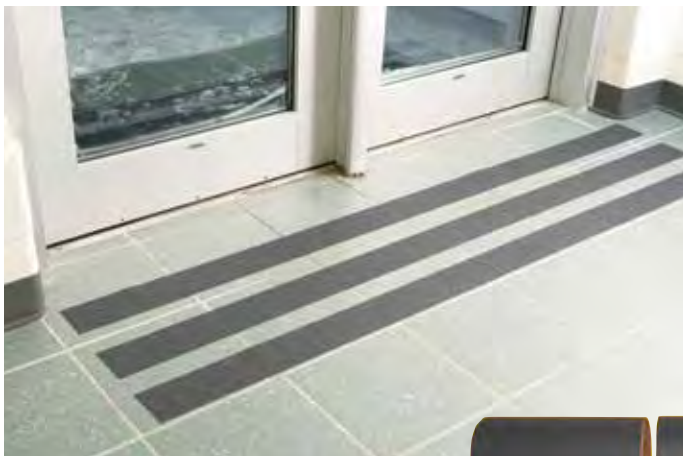

Place anti-skid floor tape on walkways, ramps, loading docks, steps, and stairways to help maintain safe stepping workplace on wet or greasy floors.

Tape has aggressive 60-grit aluminum oxide compound layer fused onto a thick PVC base. This durable surface ensures safe-footing by providing good grip, wear resistance, weatherability, and water resistance under normal traffic conditions for both indoor and outdoor environments.

Installs quickly with high-tack acrylic adhesive back. Peel off liner and adhere to most any clean, smooth, dry surface. Maintains a waterproof seal - resisting sliding, buckling, wrinkling, and peeling.

Available in black in 60-ft. rolls.

Meets ANSI/NFSI B101.1.



Size	Part #	Price / Roll
1" x 60-ft.	AFPTA101BK	\$25.68
2" x 60-ft.	AFPTA102BK	\$50.57
3" x 60-ft.	AFPTA103BK	\$67.34
4" x 60-ft.	AFPTA104BK	\$91.38
6" x 60-ft.	AFPTA106BK	\$137.59
12" x 60-ft.	AFPTA112BK	\$268.82



OSHA 29 CFR 1910.24(f)  
"Stair treads." All treads shall be reasonably slip-resistant and the nosings shall be of nonslip finish.

Designed to withstand the industrial facility and high plant traffic.

- Superior durability for high traffic locations
- Easy to apply with only one person
- Abrasion- and chemical-resistant
- Aggressive acrylic adhesive minimizes peel or lift
- Low-profile reduces tears and scratches from skids, pallet jacks, etc.
- Removes easily without leaving any adhesive residue or damage to the floor



Floor Stripe™ Marking Tape outperforms standard floor marking tapes. Heavy-duty composite tape creates a high gloss surface that resists marks and smudges and cleans up like new. The surface is water and chemical resistant which makes the cleaning fast and easy.

Long-lasting tape is ideal for marking aisles, pathways, work areas, hazard areas and storage locations, plus outlining machinery and placement of portable equipment. For optimal performance, apply to clean, flat, non-coated concrete surfaces.

Printed 2-mil polyester with 3-mil clear polycarbonate over-laminate creates a strong, durable tape that is flexible, heat resistant, long lasting, and does not stretch like traditional tapes. Acrylic adhesive provides high tack, bond to variety of smooth and rough surfaces. Minimum application temperature: 50°F. Temperature range: -40 to 302°F.



Size	Red Part #	Orange Part #	Yellow Part #	Green Part #	Blue Part #	White Part #	Black Part #	Price / Roll
2" x 100-ft.	AFPTP102RD	AFPTP102OR	AFPTP102YL	AFPTP102GN	AFPTP102BU	AFPTP102WT	AFPTP102BK	\$40.24
3" x 100-ft.	AFPTP103RD	AFPTP103OR	AFPTP103YL	AFPTP103GN	AFPTP103BU	AFPTP103WT	AFPTP103BK	\$58.71

**Floor Stripe™ High Performance Message Marking Tapes**

Identify and call attention to hazards throughout your facility. Self-adhesive vinyl, sub-surface printed and overlaminated with peel off liner. Available 3" wide x 50-ft. roll.

	<b>Price / Roll</b>
AFPTP121	\$33.75
	
AFPTP127	
	
AFPTP126	
	
AFPTP118	
	
AFPTP116	
	
AFPTP129	







**PERSONALIZE IT!**

Tapes can be custom printed with your message, graphic, or logo. Contact us with part number AFPTP155.

**Floor Stripe™ High Performance Message Floor Strips**

Mark the specific location of maintenance, storage and emergency equipment.

Self-adhesive vinyl, sub-surface printed and overlaminated with peel off liner. Available 3" wide x 12" strips.

	
AFPTP187	AFPTP189
	
AFPTP184	AFPTP186
	
AFPTP190	AFPTP183
	<b>Price / Each</b>
AFPTP181	\$13.71

**PERSONALIZE IT!**

Strips can be custom printed with your message, graphic, or logo. Contact us with part number AFPTP165.



AFPFR636

- Free-standing signs to identify temporary hazardous conditions
- .125" rugged, high-impact plastic for multiple uses and rough handling
- 20"H x 12"W with handle cut-out, folds flat
- Same message both sides

Price / Each  
\$39.40



AFPFR130



AFMF108



AFMF103



AFPFR611



AFPFR603



AFMF105



AFMF119



AFMF118



AFMF110



AFMF111



AFMF114



AFMF101DE

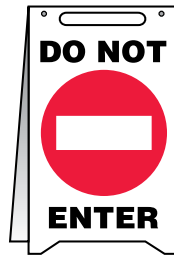

AFPFR225

**Custom Fold-Ups® and Reversible Fold-Ups®**

Personalize with your custom information. Specify part number AFPFR555 for Fold-Ups® or AFPFE455 for Reversible Fold-Ups®. Provide your ideas, specify quantity, and we will get back to you with a quote and delivery.



AFPFE403

- Versatile - two signs in one
- Flip and fold sign inside-out to reveal second message
- Lightweight, waterproof corrugated plastic with fold-and-insert-tab
- Stands 20"H x 12"W
- Carry handle cut-out on top, folds flat

Price / Each  
\$29.11

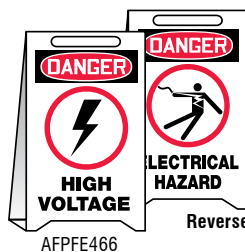

AFPFE466

Reverse

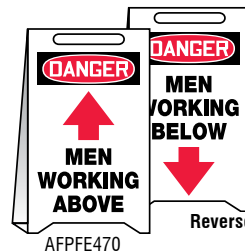

AFPFE470

Reverse



AFPFE495

Reverse



AFPFE401

Reverse



AFPFE419

Reverse



AFPFE409

Reverse



AFPFE405

Reverse

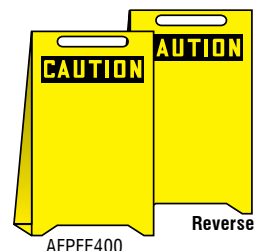

AFPFE400

Reverse



## Plastic Chain

Lightweight, yet remarkably strong, polyethylene plastic. Each link is 2" x 1" x 1/4". Available in solid colors and alternating color chain that changes color every two feet. Chain can be cut to your required length (maximum continuous length is 500-ft. except Glow Chain being 164-ft.). Available per foot.

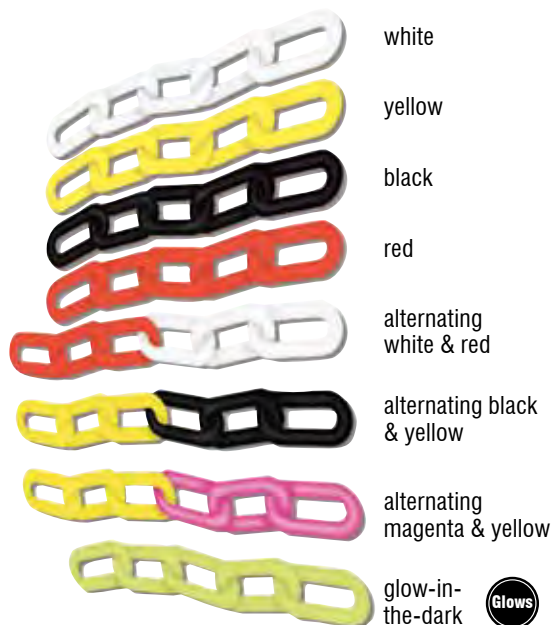

### Accessories for Chain Links

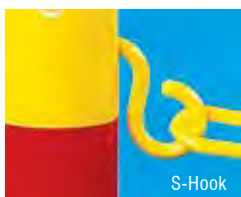

**S-Hooks** — Open ends to quickly link and unlink separate lengths of chain. Available each.



**Master Link** — Permanently joins separate lengths of chain to give a seamless look. Available each.

### PLASTIC CHAIN

Style	Color	Part #	Price / Foot	Part#	Price / Foot
Standard	Yellow	AFPRC202YL	\$0.91	AFPRC211YL	\$86.45
	Red	AFPRC202RD	\$0.91	AFPRC211RD	\$86.45
	White	AFPRC202WT	\$1.08	AFPRC211WT	\$101.71
	Black	AFPRC202BK	\$1.08	AFPRC211BK	\$101.71
Alternating	Red & White	AFPRC206RDWT	\$1.76	—	—
	Black & Yellow	AFPRC206BKYL	\$1.76	—	—
	Magenta & Yellow	AFPRC206MGYL	\$1.76	—	—
Glow					
	Glow-In-The-Dark	AFPRC208	\$3.65	—	—

### ACCESSORIES

Style	Part #	Color Code	Price / Each
Master Link Standard	AFPRC221	YL, RD, WT, BK	\$0.96
S-Hook Standard	AFPRC242	YL, RD, WT, BK	\$0.96

## Stanchion Post

# BLOCKADE

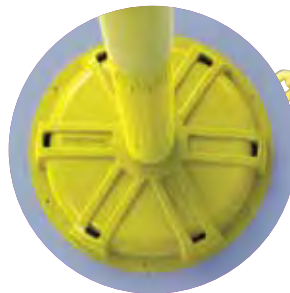

Uniquely designed stanchions can be used for crowd control, to designate aisle ways, or cordon off hazardous or restricted areas.

High density polyethylene stanchion has industrial design ideal for the plant or facility. Set out several posts with chain (sold separately) connected with included C-hooks to establish boundaries. Post stands 38" high with a sturdy, 16" wide, low-profile compartmental base which can be filled with gravel, sand or filled ring weight. Base also comes with pre-drilled holes to be secured to the floor if desired.

The 3" diameter post and base snap together for a secure, positive lock rather than the standard press-fit design. Snap lock ensures the post will not pull out from the base when lifted and moved. Unit breaks down and stacks for compact storage.

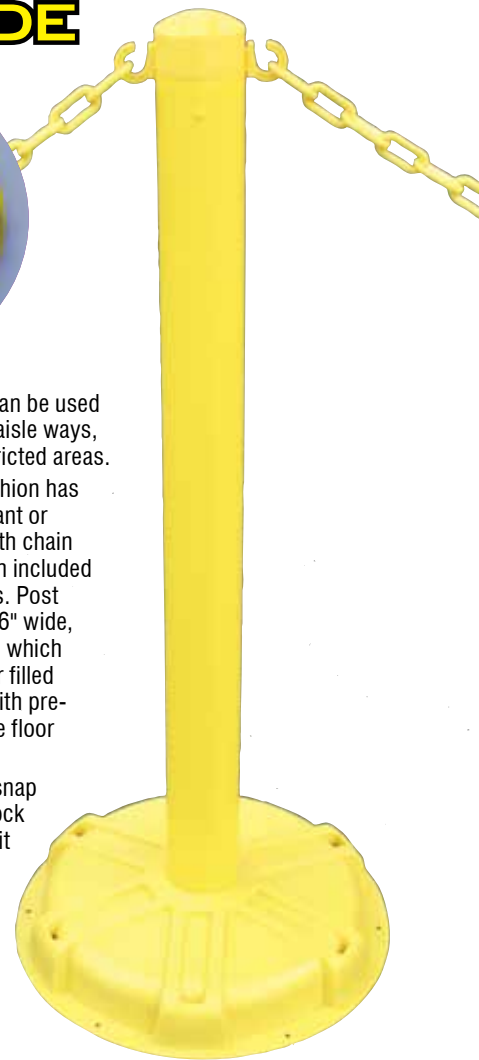

### STANDARD YELLOW POST

Height	Par #	Price / Each
38"	AFPRC441YL	\$35.42

## Fiberglass Stakes

Heavy-duty, fiberglass reinforced composite stakes are nearly indestructible. Ten times stronger than typical thermoplastic. Stake is 66" long x 3 3/4"W with 1/4" thick center and 3/8" thick ribbed-edge design for structural rigidity. Install by driving pointed end into the ground (recommended depth of 18 to 24 inches).



To order, add stake color code after part number.

Part #	Price / Each
Fiberglass Stake - See colors FMK600	\$28.11
Post Driver FMK900	\$307.80

### STAKE COLOR CODES

Stakes are available in the following colors:

White - WT	Brown - BR
Yellow - YL	Blue - BU
Orange - OR	Red - RD
Green - GN	

## Flexible Marker Stakes with Reflective Decals

Engineer-Grade Reflective decal, 14" x 3", is available on one side or both sides of the stake. Decal is also available separately for retrofit field installation.



Red- RD	Orange - OR	Yellow- YL	White- WT	Blue- BU	Black/Yellow- BKYL	Black/Orange- BKOR	Red/White- RDWT	Orange/White- ORWT
AFFMK200	AFFMK202	AFFMK204	AFFMK206	AFFMK208	AFFMK221	AFFMK223	AFFMK225	AFFMK227

To order, add stake color code (from above) and decal color code (shown in gray bar) to stake part number. (ex: AFFMK611WTRD)

STAKE W/DECAL Material	DECAL - ONE SIDE Part #	Price / Each	DECAL - BOTH SIDES Part #	Price / Each
Fiberglass Stake	AFFMK611	\$39.05	AFFMK613	\$45.68

### Decal Only

To order, specify by part number beneath Decal color code.

Item	Price / Each
Decal only	\$7.84

## Flexible Marker Stake with Utility Line-Marking Labels

14" x 3" printed Adhesive Dura-Vinyl label with space to add contact phone number on the bottom, is available on one side or both sides of the stake. Label is also available separately for retrofit field installation.



Stock Label Only	AFFMK320	AFFMK322	AFFMK324	AFFMK326	AFFMK328	AFFMK330	AFFMK332	AFFMK334	AFFMK336	AFFMK338
Semi-Custom Label Only	AFFMK402	AFFMK404	AFFMK406	AFFMK408	AFFMK410	AFFMK412	AFFMK414	AFFMK416	AFFMK418	AFFMK420

To order, add stake color code (from above) followed by label letter code (shown in gray bar) to stake part number. (ex: AFFMK617WTA)

STAKE W/LABEL Material	LABEL - ONE SIDE Part #	Price / Each	LABEL - BOTH SIDES Part #	Price / Each
Fiberglass Stake	AFFMK617	\$38.51	AFFMK619	\$44.56

### Label Only

To order, specify by part number beneath Label letter code.

Item	Price / Each
Label only	\$7.17

### PPE-ID™ Chart & Label Booklet Kit

Create and display a visual chart identifying Personal Protective Equipment (PPE) required for use by employees, contractors, and visitors. Ideal for posting at entrances, doorways, time-clock, lockers, and more – capture their attention and remind them about your company's PPE policy of what is to be worn and used, in and around your facility.

This 24" x 18" chart is designed so that you can add basic specific identifiable PPE as required. Chart is a template with blank spaces provided that is filled in by placing PPE product pictorials from the included Label Booklet. The labels within the booklet represent today's most common PPE products. Also create and post additional charts featuring PPE requirements specific to different hazard areas. PPE-ID™ Chart is printed on sturdy 1/8" over-laminated Plastic Lite. Label Booklet contains 2" x 2" self-adhesive vinyl images of commonly recognized standardized PPE, broken down into popular categories; body, eye, foot, hand, head, hearing, and respiratory. Easily peel and place the appropriate label onto the available spaces on the chart.

#### PPE-ID™ Chart Kits can:

- Help visually identify basic PPE requirements
- Enhance and reinforce usage
- Help non-English speaking workers quickly recognize PPE
- Show your commitment to a safe workplace

Item	Part #	Price / Each
PPE-ID™ Chart & Label Booklet Kit	AFPPE248	\$57.85
PPE-ID™ Chart only	AFPPE357	\$38.51
Label Booklet only	AFPPE468	\$29.36

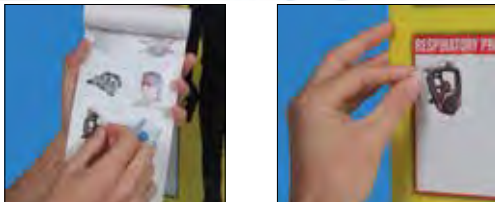

### Write-A-Day Scoreboards



Update safe working days on large scoreboard by writing in the number with dry-erase marker.

- Keep score of consecutive days
- Wipe-off and write-in on poly-coated space provided
- Constructed of durable plastic
- Corner mounting holes

Size	Price / Each
20" x 14"	\$39.31
28" x 20"	\$52.19
36" x 24"	\$71.45



20" x 14" AFMSR137PL  
28" x 20" AFMSR262PL  
36" x 24" AFMST242PL

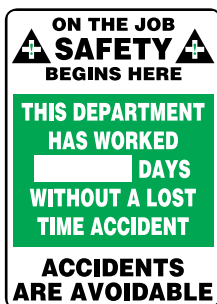

20" x 14" AFMSR120PL  
28" x 20" AFMSR241PL



20" x 14" AFMSR122PL  
28" x 20" AFMSR243PL



20" x 14" AFMSR135PL  
28" x 20" AFMSR260PL  
36" x 24" AFMST244PL



20" x 14" AFSBMSR129PL  
28" x 20" AFSBMSR249PL



20" x 14" AFMSR132PL  
28" x 20" AFMSR234PL



Keep track of safe days automatically. Heighten awareness and visibility of safe work days, and take the chore out of manually changing the number.

- Bright, red LED numbers
- Frameless design, lightweight aluminum scoreboard
- Printed image goes to the edge and wraps around the sides for depth and visual impact
- Internal clock advances automatically by one, every 24 hours; set to change any time of day
- Operate tamper-proof scoreboard with easy-to-use, small remote control
- Last number saved in event of power failure

**Digi-Day® Specifications:**

- For indoor use
- 28" x 20" aluminum construction
- Four-digit, red LED display with 2-1/2" H numbers
- Operates on 120 VAC with 6-ft. power cord

**Digi-Day® Plus+ Specifications:**

- For wet, damp, harsh locations\*
- 36" x 24" aluminum construction
- Four-digit, bright LED display with 4" H numbers
- Operates on 120 VAC with 12-ft. power cord
- IP65 tested for dust and water resistance

\*Power receptacle exposed to wet environment should be plugged into a GFI outlet with weatherproof protective receptacle cover.

Style	Price / Each
Digi-Day®	\$249.45
Digi-Day® Plus+	\$545.25



Digi-Day® AFSCA219  
Digi-Day® Plus+ AFSCM307



Digi-Day® AFSCA275  
Digi-Day® Plus+ AFSCM386



Digi-Day® AFSCA230  
Digi-Day® Plus+ AFSCM308



Digi-Day® AFSCA218  
Digi-Day® Plus+ AFSCM302



Digi-Day® AFSCA236  
Digi-Day® Plus+ AFSCM310



Digi-Day® AFSCA215\*  
Digi-Day® Plus+ AFSCM327\*



Digi-Day® AFSCA238\*  
Digi-Day® Plus+ AFSCM312\*

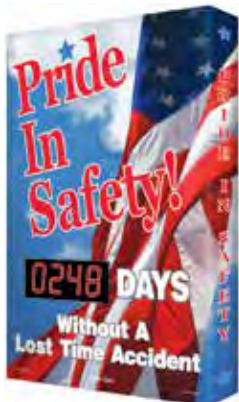

Digi-Day® AFSCA248  
Digi-Day® Plus+ AFSCM319



Digi-Day® AFSCA243  
Digi-Day® Plus+ AFSCM314



Digi-Day® AFSCA273  
Digi-Day® Plus+ AFSCM324



Digi-Day® AFSCA234  
Digi-Day® Plus+ AFSCM346



Digi-Day® AFSCA239  
Digi-Day® Plus+ AFSCM313

\*Includes one electronic display and one magnetic display with changeable number set (for "best previous record").



Proudly display safe work days that count up in green – electronically and automatically – with the next generation Digi-Day®2. The LED display mounts in a frameless designed scoreboard. Innovative scoreboard design takes the image to the edge and wraps it around each side for visual depth.

**Show Display in 2 Ways**

Be able to control the LED to display only the safe days count, or flash between safe days, time, and date. Internal clock automatically advances based on your setting preference.

**Track Days 2 Ways**

Track the full 7-day week, and the count accumulates continuously for each day. Or, count only working days. Does your company work 4, 5, or 6 days? Now you can set to track only those days.

**Additional Features**

The display count can be set to freeze or hold. In the event of a power failure, all the information remains stored; then operations resume when power returns. There are notification indicators for the hold and power failure events.

**Price / Each**  
\$299.85



Digi-Day®2 AFSCG158



Digi-Day®2 AFSCG156

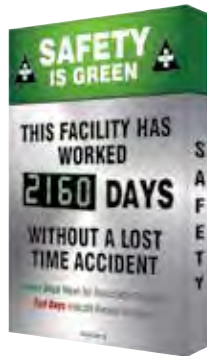

Digi-Day®2 AFSCG160



Digi-Day®2 AFSCG162



Digi-Day®2 AFSCG164



Digi-Day®2 AFSCG103



Digi-Day®2 AFSCG109



Digi-Day®2 AFSCG111



Digi-Day®2 AFSCG117



Digi-Day®2 AFSCG119

Scoreboards featuring "best previous record" include: One (1) electronic display to count safe days and one (1) magnetic display with changeable numbers set to track record number of days.

**PERSONALIZE IT!**

**Custom Digi-Day™2 Electronic Scoreboards**

Personalize your Digi-Day®2 with your specific message, symbols, company logo, corporate colors, and full-color images.

1. Write or sketch out your Digi-Day®2 idea
2. Indicate your desired size
3. Specify quantity
4. Call, fax, or e-mail your request

Size	Part #	Price / Each
28" x 20"	AFSCG155	\$387.91
other	AFSCG255	call for quote



Posters communicate the importance of safety, procedures, and practices throughout the workplace.

- Post on walls in key locations to provide a daily visual reminder
- Support and spread the program message
- Printed with color and graphic images
- Laminated, durable, flexible plastic

Size Price / Each  
18" x 24" \$29.48



24" x 18" AFPST420



24" x 18" AFPST133

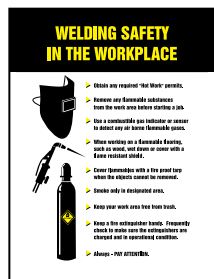

24" x 18" AFPST324



24" x 18" AFPST220



24" x 18" AFPST403

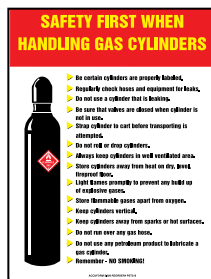

24" x 18" AFPST318



24" x 18" AFPST137



24" x 18" AFPST101



24" x 18" AFPST104



24" x 18" AFPST122



24" x 18" AFPST106



24" x 18" AFPST160



24" x 18" AFPST164



24" x 18" AFPST107



18" x 24" AFPST722



18" x 24" AFPST728

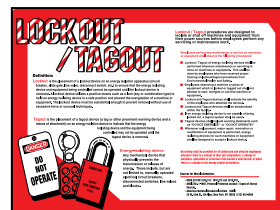

18" x 24" AFPST601



18" x 24" AFPST211



18" x 24" AFPST754



18" x 24" AFPST823

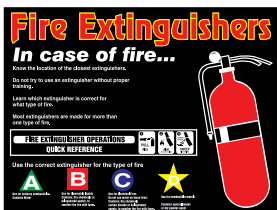

18" x 24" AFPST405



18" x 24" AFPST108

**Custom Posters**

Incorporate your own graphics, images and logos, making each poster a unique tool for training, communicating safety and procedures. Plastic posters are laminated, durable, and flexible. Price per Each.

Size	Part #	1 - 5	6 - 9	10 - 24	25 - 49	50 - 99	100+
8-1/2" x 11"	AFPST811	\$33.54	\$21.97	\$13.99	\$10.65	\$5.88	\$5.34
12" x 18"	AFPST1218	\$42.14	\$30.54	\$22.68	\$19.96	\$12.88	\$11.19
18" x 24"	AFPST1824	\$70.74	\$53.31	\$41.34	\$35.71	\$25.34	\$24.56
24" x 36"	AFPST2436	\$110.45	\$83.08	\$64.48	\$51.02	\$39.54	\$38.28
Other Sizes	AFPST555	Call for quote					



Promote and motivate safety in a BIG way.

- Eye-catching phrases, bold color graphics and images
- Hang high to look up and see the message of safety
- Printed on durable reinforced flexible, poly sheeting
- Single-sided banners are ideal for long life indoors and durable for outdoors
- Double-stitched hems and metal grommets
- Four 2-ft. nylon ropes included



28" x 8-ft. AFMBR880



28" x 8-ft. AFMBR813



28" x 8-ft. AFMBR882



28" x 8-ft. AFMBR866



28" x 8-ft. AFMBR864



28" x 8-ft. AFMBR819



28" x 8-ft. AFMBR832

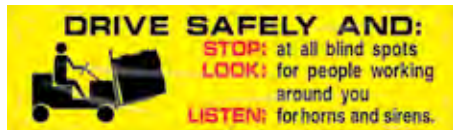

28" x 8-ft. AFMBR830



28" x 8-ft. AFMBR833



28" x 8-ft. AFMBR802



28" x 4-ft. AFMBR426



28" x 4-ft. AFMBR422



28" x 8-ft. AFMBR817



28" x 8-ft. AFMBR846



28" x 4-ft. AFMBR424



28" x 4-ft. AFMBR420



28" x 8-ft. AFMBR870

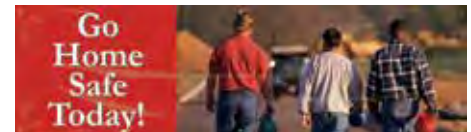

28" x 8-ft. AFMBR888

Size	Price / Each
28" x 4-Ft.	\$59.99
28" x 8-Ft.	\$89.71



28" x 8-ft. AFMBR862



28" x 8-ft. AFMBR850

### Custom Banners

Create a custom banner for any occasion or announcement, training, promotions, special events, achievements, campaigns, recognition, and more. Price per Each.

*Don't see what you're looking for? Additional sizes and double-sided custom banners are also available. Call us for details.*

Size	Part #	1 - 5	6 - 9	10+
Horizontal				
28" x 4-Ft.	AFMBR540	\$92.05	\$80.05	\$66.71
28" x 8-Ft.	AFMBR580	\$137.54	\$119.60	\$99.68
34" x 5-Ft.	AFMBR510	\$113.31	\$98.51	\$82.08
34" x 10-Ft.	AFMBR520	\$176.65	\$153.60	\$127.99
46" x 10-Ft.	AFMBR530	\$210.22	\$182.79	\$152.34
Other Sizes	AFMBR525	Call for quote		



Wind-resistant, mesh banners offer an indoor/outdoor banner solution for your safety and motivation messages.

- Mesh material holds up to high winds
  - Heavy-duty design stands up to the elements
  - Bold color graphics and images convey the message
- Made from 11 oz. polyester mesh material, banners are reinforced with grommets and double-stitched hems. Small openings in the mesh and surface area clearly display graphics and messages while allowing wind to pass through, reducing wind load stress and preventing the banner from ripping. Images and messages are digitally printed with vibrant colors in high-resolution. UV-resistant ink prevents fading. Four nylon ropes included.



AFMBM326

Size	Price / Each
4-ft. x 10-ft.	\$107.99

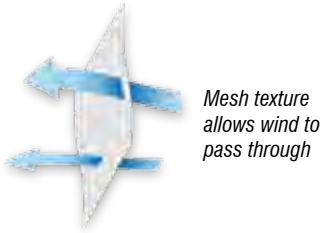

4-ft. x 10-ft. AFMBM317



4-ft. x 10-ft. AFMBM313



4-ft. x 10-ft. AFMBM301



4-ft. x 10-ft. AFMBM303



4-ft. x 10-ft. AFMBM307



4-ft. x 10-ft. AFMBM319



4-ft. x 10-ft. AFMBM316



4-ft. x 10-ft. AFMBM311



4-ft. x 10-ft. AFMBM305



4-ft. x 10-ft. AFMBM322



4-ft. x 10-ft. AFMBM324

# PERSONALIZE IT!

Keep your workplace informed and motivated with unique, customized banners that will hold up – indoors and out. Personalize your banner with bright, colorful, eye-catching. Convey the message, using your words, phrases, colors, full-color images and logos.

**How to Order:**

- Step 1:** Specify size by part number
- Step 2:** Write your message
- Step 3:** Include a sketch or file of your image, design, logo, etc.
- Step 4:** Pick your colors
- Step 5:** Place your order

Size	Part #	Price / Roll
4-ft. x 10-ft.	AFMBM325	\$142.60
Other size	AFMBM355	Call for quote



Repeat your message on custom banners to beautify facility fencing. Include your colors, messages, images and corporate brand.

Wind-resistant banners are made from 11 oz. polyester mesh material, reinforced with grommets and double-stitched hems. Custom design is digitally printed within UV-resistant inks and high-resolution, clear images.

Fence-Wrap™ comes in 4-ft. wide rolls up to 150-ft. long with a maximum graphic length of 150-ft. Available with repeatable image within maximum length.

For other custom requirements, contact us with your specifications, and refer to part number AFFBW555 for a quote.

**How to Order:**

- Step 1:** Specify roll size by part number
- Step 2:** Provide your message, and specify if it repeats
- Step 3:** Include a sketch or file of your image, design, logo, etc.
- Step 4:** Pick your colors
- Step 5:** Place your order

Roll Size	Part #	Price / Roll
4-ft. x 10-ft.	AFFBW105	\$143.97
4-ft. x 25-ft.	AFFBW115	\$315.28
4-ft. x 50-ft.	AFFBW125	\$600.80
4-ft. x 75-ft.	AFFBW135	\$886.37
4-ft. x 100-ft.	AFFBW145	\$1171.91
4-ft. x 150-ft.	AFFBW155	\$1742.97



# PERSONALIZE IT!

Get personalized identification badge cards that are durable and good-looking with photo-quality images. Full-color identification cards are created using advance dye-sublimation and thermal resin transfer print technology. Cards can be printed with graphics and individual information — such as names, numbers, and bar codes — as well as photo images. The card is laminated with a sheer clear-gloss film to permanently seal and protect the image, providing maximum durability and resistance to abrasion and color-fading. Printed on 15-mil polypropylene that is laminated on both sides with 10-mil (34-mil total). Print can be done on one side or both sides.

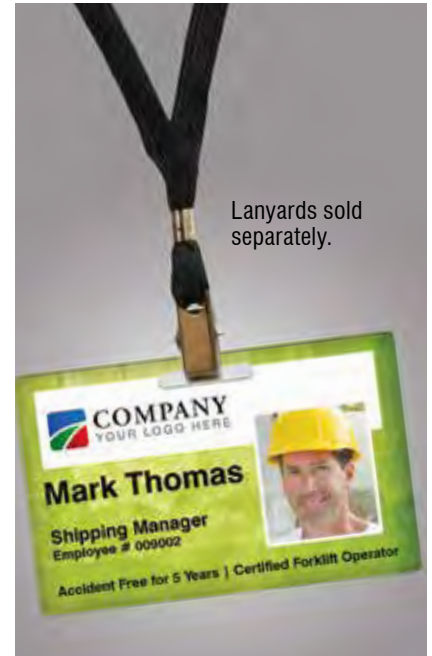

Lanyards sold separately.

### How to order:

- Create a standard design template or incorporate your company logo. Send your information to us in an electronic file format, Illustrator EPS (with all fonts/typefaces turned to outlines/curves) or we can scan an actual design/logo.
- List out the names and/or numbers required - sequential or otherwise. If bar codes are required, please specify the symbology.
- Point out your color requirements - including PMS numbers.

For photo-quality images, please provide: high-resolution electronic TIF format file - Mac or PC; or actual photograph to be scanned. Verify the quantity of badges.

Style	Part #	10 - 24	25 - 49	50 - 99	100 - 249	250 - 499	500 - 999	1000+
Single-side	AFDNT655	\$7.79	\$6.51	\$5.51	\$4.68	\$3.73	\$2.82	\$2.34
Double-side	AFDNT755	\$11.68	\$9.73	\$8.25	\$6.99	\$5.57	\$4.25	\$3.53

Other card style options are available, contact us with part number AFDNT555 and specify your requirements for a quote and delivery time.

## Non-Breakaway Lanyards

## Breakaway Lanyards



**Round Cord**  
1/8" round braided cord, non-breakaway. 36" length. Available package of 10.



**Flat Poly**  
3/8" flat tubular 2-ply polyester lanyard, non-breakaway. 36" length. Available package of 10.



**Soft Braided Round**  
Thick, high quality cord feels comfortable around the neck. Has 3/4" diameter adjustable blank disk and detachable buckle end for extended access to end attachment. Barrel breakaway. 36" length. Available package of 10. 3/4" diameter disk can be imprinted with your logo or design. Contact us with part number AFDNH645 for a quote.

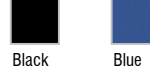

**Flat Poly**  
3/8" flat tubular 2-ply polyester lanyard with barrel breakaway. 36" length. Available in package of 10.



Style	Black #	Blue #	Red #	Price / Pkg. of 10
Round Cord Swivel Hook	AFDNH636BK	AFDNH636BU	AFDNH636RD	\$10.47
Round Cord Bulldog Clip	AFDNH637BK	AFDNH637BU	AFDNH637RD	\$10.47
Flat Poly Swivel Hook	AFDNH630BK	AFDNH630BU	AFDNH630RD	\$10.47
Flat Poly Bulldog Clip	AFDNH632BK	AFDNH632BU	AFDNH632RD	\$10.47

Style	Black #	Blue #	Red #	Price / Pkg. of 10
Soft Braided Round Swivel Hook	AFDNH646BK	AFDNH646BU	AFDNH646RD	\$38.36
Soft Braided Round Bulldog Clip	AFDNH647BK	AFDNH647BU	AFDNH647RD	\$38.36
Soft Braided Round Split Ring	AFDNH648BK	AFDNH648BU	AFDNH648RD	\$38.36
Flat Poly Swivel Hook	AFDNH639BK	AFDNH639BU	AFDNH639RD	\$14.79
Flat Poly Bulldog Clip	AFDNH640BK	AFDNH640BU	AFDNH640RD	\$14.79



# PERSONALIZE IT!

Use Site-Boards™ visual communication centers to display KPIs (Key Performance Indicators), report on lean/Kaizen activities, or display production and scheduling plans. The dry-erase surface makes changing information easy and is stain and scratch resistant from splashes and abrasions. Site-Boards™ are customized to your requirements - any size and shape with any colors, images, logos and graphic schemes.

**How to Order:**

- Determine Site-Boards™ Requirements - Choose size and material, and note any special components or accessories\*, such as: sheet protectors, pockets, clips, magnetic strips, etc.
- Request an art proof - We will schedule your personalized WebEx™ to finalize your design
- Receive your personalized price quote
- Approve your artwork, and we produce your Site-Boards™

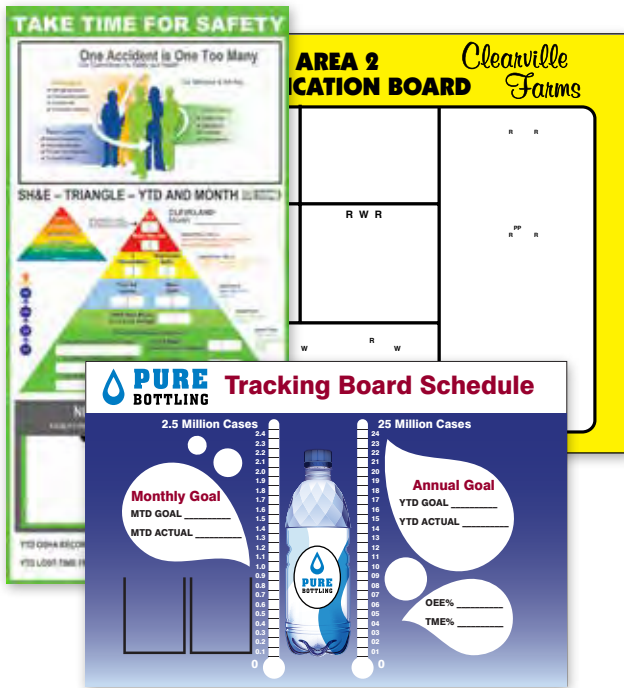

**ULTRA ALUMA-LITE™**

High-strength, lightweight, nearly 1/4" thick composite aluminum with thermoplastic core and overlaminated print.



Size	Part #	Price / Each
24" x 36" (2-ft x 3-ft)	AFPBT420	\$272.28
36" x 48" (3-ft x 4-ft)	AFPBT422	\$416.74
48" x 72" (4-ft x 6-ft)	AFPBT424	\$672.79
48" x 96" (4-ft x 8-ft)	AFPBT426	\$731.39
Other size	AFPBT455	Call for quote

**MAX-DUTY GALVANIZED STEEL**

Rugged, 24-gauge steel offers magnetic board option. Galvanized to prevent rust and corrosion.



Size	Part #	Price / Each
24" x 36" (2-ft x 3-ft)	AFPBT313	\$201.62
36" x 48" (3-ft x 4-ft)	AFPBT315	\$302.48
48" x 72" (4-ft x 6-ft)	AFPBT317	\$453.65
48" x 96" (4-ft x 8-ft)	AFPBT319	\$604.85
Other size	AFPBT355	Call for quote

**MAX-DUTY ALUMINUM**

Durable .080" aluminum provides the strength of metal but will not rust. Overlaminated print.



Size	Part #	Price / Each
24" x 36" (2-ft x 3-ft)	AFPBT102	\$201.62
36" x 48" (3-ft x 4-ft)	AFPBT104	\$302.48
48" x 72" (4-ft x 6-ft)	AFPBT106	\$453.65
58" x 96" (4-ft x 8-ft)	AFPBT108	\$604.85
Other size	AFPBT155	Call for quote

\*Pricing includes custom design and material by size. For components and accessories, contact us for a quote.



**Design your Site-Boards™ with us online, in real time ... at no extra cost!**

Interact with our graphic artist in real time to develop your Site-Boards™. Your artwork comes to life right before your eyes. You get exactly what you want versus settling for something close.

**Contact us to have professionally designed Site-Boards™ customized for you.**

Site-Boards™ are designed with protection to maintain the printed images. Graphics, wording, and message will remain unchanged in clarity, color, and sharpness throughout the durability period. Site-Boards™ are sold with the understanding that the buyers will test this material, in actual use, to determine for themselves its adaptability to their intended environment and use(s). We warrant that Site-Boards™ are free from defects in material and workmanship, but limit obligation under this warranty to replacement of the product shown, to our satisfaction, to have been defective at the time we sold it. This warranty does not extend to any persons obtaining the product from the buyer. Under no circumstances will we be liable for any loss, damage, expense, or consequential damages of any kind arising in connection with the use, or inability to use Site-Boards™. We will not be liable for defects that are the result of product abuse, misuse, alteration or modification; or for defects that are due to a failure to install, maintain, or use of the product in accordance with our provided installation instructions.

**TRUCK SHIPMENTS (LTL - Less than Truckload)** We are committed to getting items only transportable by truck to you in excellent condition, and in a timely manner. We know that your business depends on speed and convenience. To assist in providing advance notice on items that **MUST** ship by truck, we have identified those items with a truck icon throughout this catalog. If you do not have a preferred LTL carrier, we will help determine the best carrier for your order. On occasion, large quantity orders may be more cost effective to ship via LTL carrier; in these instances, you will be notified prior to shipment. Truck shipments do not qualify for any special shipping promotions.



# PERSONALIZE IT!

Foam Organizers designate a place for every tool in your tool box, drawer, chest, cabinet, station, or tray. When a tool is removed, the tool's 'shadow' visually identifies that it is in use, missing, left behind, misplaced, not returned, or lost.

Dense, textured polyethylene foam is chemically cross-linked to be durable, heat stable, yet lightweight. Resistant to oils, solvents and jet fuels. Available standard or, for an additional cost, with your information – company name, department name, logo, tool name, tool part number, etc. – printed in color onto the foam.

**Features:**

- 3/4" thick dual-layered foam
- Top 1/2" layer contains precision laser-cutout silhouettes of your tools in contrast color to the 1/4" bottom layer
- Tool Spacing: 1/2" minimum space between tool cutouts; minimum 5/8" from the edge; narrowest cutout is 1/4" wide
- Finger Pockets: Semi-circular opening next to tool shape to easily remove small tools

**How to Order:**

- Choose color combination and foam style by part number – standard or with print
- Provide the inside dimensions to fit each drawer, tray, or tool box requested – include at least two decimal places on each dimension
- Indicate the desired quantity – number of drawers or tool box inserts
- Contact us for a quote – see instructions and options in 'How It Works'. Price Guideline Table provided to approximate the price of your Store-Drawers™ Organizers

**Color Combination**

Black/Red      Black/Yellow      Blue/Red      Blue/Yellow

**STORE-DRAWERS™ ORGANIZERS**

Color Combination (Top/Bottom)	Standard Part #	With Print Part #
Black/Red	AFPDR112BKRD	AFPDR126BKRD
Black/Yellow	AFPDR112BKYL	AFPDR126BKYL
Blue/Red	AFPDR112BURD	AFPDR126BURD
Blue/Yellow	AFPDR112BUYL	AFPDR126BUYL

**PRICE GUIDELINE TABLE**

**Example Drawer Size, Approx. (W x D)**

Approx. (W x D)	Standard Price (Approx.)	With Print Price (Approx.)
18" x 12"	\$139.80	\$174.77
27" x 12"	\$198.68	\$248.34
27" x 18"	\$285.31	\$356.62
36" x 18"	\$375.28	\$469.05
27" x 27"	\$397.73	\$477.28
36" x 27"	\$525.19	\$617.85
36" x 36"	\$681.77	\$802.08
54" x 27"	\$750.05	\$882.45

Pricing is based and calculated by finished size of your Store-Drawers™ Tool Control Foam Organizers. Contact us for a quote.

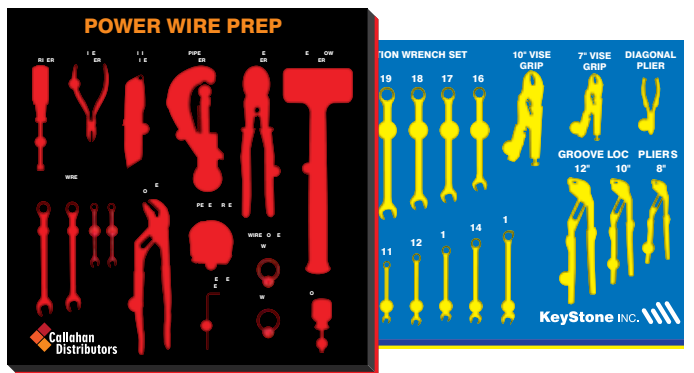

**Design your Store-Drawers™ with us online, in real time ... at no extra cost!**

Interact with our graphic artist in real time to develop your Store-Drawers™. Your artwork comes to life right before your eyes. You get exactly what you want versus settling for something close.



**Contact us to have professionally designed Store-Drawers™ customized for you.**

**How it works:**



**STEP 1:**

Request a quote – based on foam style, sizing and quantity. Once you approve your quote, proceed to step 2.

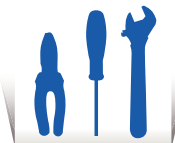

**STEP 2:**

Identify your tools and layout requirements, specific to each Organizer. You must include at least two decimal places on each dimension.



**STEP 3:**

Schedule a live, interactive art proof session (via WebEx™), and collaborate with our graphic artist on your Organizer's design.



**STEP 4:**

An art proof is emailed for your approval. Once approved, your personalized Organizer is created and shipped in short-order.



# PERSONALIZE IT!

Organize tools, supplies and equipment to promote efficiency, effectiveness and safety. Store-Boards™ have shadow outlines showing when tools are in use or missing, and the proper place to return tools. Ideal for use in 5S and other lean practices. Store-Boards™ are customized to your requirements - any size and shape with any colors, images, logos and graphic schemes.

**How to Order:**

- Determine Store-Boards™ requirements - Choose size and material, note any special hardware/holders\*, and be prepared to identify equipment to be shadowed
- Request an art proof - We can schedule your personalized WebEx™ to finalize your design
- Receive your personalized price quote
- Approve your artwork, and we produce your Store-Boards™



**Design your Store-Boards™ with us online, in real time ... at no extra cost!**

Interact with our graphic artist in real time to develop your Store-Boards™. You get exactly what you want versus settling for something close.

**Contact us to have professionally designed Store-Boards™ customized for you.**



Choose a material to fit your location, application, and durability needs.

**AccuShield™**



Heavy-duty for demanding industrial locations. 3/16" thick with subsurface print.

**AccuShield™ FB-X**



Designed to withstand the conditions in food and beverage environments – including ammonia wash-downs. 3/16" thick with subsurface print.

**ULTRA ALUMA-LITE™**



High-strength, lightweight, nearly 1/4" thick composite aluminum with thermoplastic core and overlaminated print.

**MAX-DUTY ALUMINUM**



Durable .080" aluminum provides the strength of metal but will not rust. Overlaminated print.

**DIAMOND ALUMINUM**



Industrial rugged appearance with overlaminated print on tough .080" aluminum.

When ordering, refer to part number below for a quote.

ACCU-SHIELD™	ACCU-SHIELD™ FB-X	ULTRA ALUMA-LITE™	MAX-DUTY ALUMINUM	DIAMOND ALUMINUM
Part #	Part #	Part #	Part #	Part #
 AFPSB155	AFPSB955	AFPSB755	AFPSB655	AFPSB855

▼ BEFORE



▼ AFTER

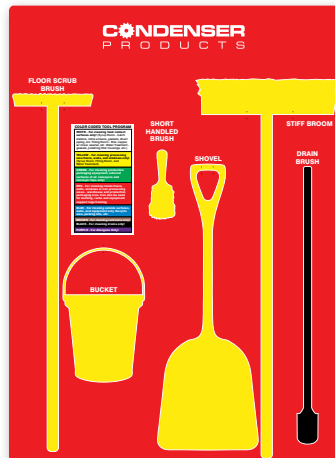

\*Store-Boards™ include all requested galvanized steel tool hangers/hooks. Stainless steel available by quote. For other hardware/holder options such as pegs, hooks, or shelves, contact us for a quote.

Store-Boards™ are designed with protection to maintain the printed images. Graphics, wording, and message will remain unchanged in clarity, color, and sharpness throughout the durability period. Store-Boards™ are sold with the understanding that the buyers will test this material, in actual use, to determine for themselves its adaptability to their intended environment and use(s). We warrant that Store-Boards™ are free from defects in material and workmanship, but limit obligation under this warranty to replacement of the product shown, to our satisfaction, to have been defective at the time we sold it. This warranty does not extend to any persons obtaining the product from the buyer. Under no circumstances will we be liable for any loss, damage, expense, or consequential damages of any kind arising in connection with the use, or inability to use Store-Boards™. We will not be liable for defects that are the result of product abuse, misuse, alteration or modification; or for defects that are due to a failure to install, maintain, or use of the product in accordance with our provided installation instructions.

 **TRUCK SHIPMENTS (LTL - Less than Truckload)** We are committed to getting items only transportable by truck to you in excellent condition, and in a timely manner. We know that your business depends on speed and convenience. To assist in providing advance notice on items that **MUST** ship by truck, we have identified those items with a truck icon throughout this catalog. If you do not have a preferred LTL carrier, we will help determine the best carrier for your order. On occasion, large quantity orders may be more cost effective to ship via LTL carrier; in these instances, you will be notified prior to shipment. Truck shipments do not qualify for any special shipping promotions.



# First Aid/Medical



### A. First Aid Kits

These kits are packaged in soft-sided durable, red nylon bags. Their portability makes it easy for the first responder to carry them to the site of an emergency. The small kits are ideal for recreation and travel. Small, medium and large kits are ANSI Z308.1 -2003 compliant



SKU	Description	UOM	Price
NORM018502	Soft pack first aid kit, small	EA	\$23.06
NORM018501	Soft pack first aid kit, medium	EA	\$33.08
NORM018500	Soft pack first aid kit, large with shoulder strap	EA	\$69.46

Refill Item #	Description	Small	Medium	Large
NORM03-20-71	Adhesive bandage, 1" x 3", cloth	-	-	1
NORM02-00-10	Adhesive bandage, knuckle & fingertip, cloth	4	4	4
NORM02-00-20	Adhesive bandage, knuckle, cloth	4	4	6
NORM02-07-01	Adhesive bandage, 1" x 3", plastic 32/bx	-	1	-
NORM02-07-95	Adhesive bandage, 1" x 3", plastic 16/bx	1	-	-
NORM03-20-74	Adhesive bandage, XL	4	4	4
NORM02-04-45	Adhesive tape, 1/2" x 2-1/2 yd.	1	1	1
	Adhesive tape, 1" x 5 yd.	-	-	1
NORM02-01-25	Antibiotic ointment	-	1	1
NORM03-22-03	Antiseptic spray, 2 oz.	-	-	1
NORM03-22-04	Burn relief spray, 2 oz.	-	-	1
NORM02-07-66	Compress, bandage, offset, 2"	-	-	1
	Compress, gauze, 18" x 36"	1	1	1
NORM04-50-28	Conforming bandage, 2" x 6 yd., ns	-	1	2
NORM03-14-00	Eye pad, sterile	-	2	4
NORM02-01-35	First aid/burn cream with aloe	6	6	-
NORM04-50-27	First aid guide	1	1	1
	Forceps, pointed, plastic	1	1	1
	Gauze pads, sterile 3" x 3"	4	4	10
NORM02-11-61	Hydrocortisone, 1.0%, 1/32 oz.	-	-	1
NORM02-06-67	Instant Cold Pak	1	1	2
NORM02-12-01	PVP iodine wipes	10	10	10
NORM75-25-77	Scissors, angled, red handle	1	1	1
	Self adherent wrap, 3 x 5 yd.	-	-	1
NORM02-16-40	Medical gloves (pair)	1	1	1
	Trauma pad, sterile, 5" x 9"	-	-	1
NORM02-03-74	Triangular bandage, NS	1	1	1
NORM02-03-80	Wire splint	-	-	1

### B. Unitized First Aid Kits

These sturdy and durable kits are weatherproof and equipped with carrying handles and mounting brackets for versatile mounting throughout the facility. Kits are ANSI Z308.1-2003 compliant.



SKU	Description	UOM	Price
NORM019708	First aid kit, 10 unit, plastic (Medsafe Logo)	EA	\$22.32
NORM019709	First aid kit, 10 unit, steel (Medsafe Logo)	EA	\$30.89
NORM01-97-11	First aid kit, 16 unit, steel (Medsafe Logo)	EA	\$41.17
NORM01-97-13	First aid kit, 24 unit, steel (Medsafe Logo)	EA	\$54.71

Refill Item #	Description	Pieces Per Unit	10	16	24	36
			Unit Kit	Unit Kit	Unit Kit	Unit Kit
NORM02-07-95	Adhesive bandage, 1" x 3", plastic	16	1	2	3	4
NORM02-04-45	Adhesive tape, 1/2" x 2-1/2 yd.	2	1	1	1	2
NORM02-06-67	Bandage compress, 3"	2	-	-	-	1
NORM02-07-68	Bandage compress, 4"	1	-	1	1	1
NORM02-06-99	1 oz. eyewash	1	-	1	1	2
NORM02-08-55	Fingertip bandage, cloth	10	-	-	1	2
NORM02-01-35	First aid/burn cream with aloe	6	1	1	2	2
NORM04-50-27	First aid guide	1	1	1	1	1
NORM02-05-50	Forceps and scissors	2	1	1	1	1
NORM02-06-67	Instant Cold Pak	1	1	1	1	2
NORM02-06-30	Gauze bandage 2" x 6 yd.	2	-	-	1	2
NORM02-06-45	Gauze compress, 36" square	1	1	1	1	2
NORM02-04-30	Gauze pads, 3" x 3", sterile	4	1	1	2	2
NORM02-00-20	Knuckle bandage, cloth	8	-	1	1	2
NORM02-12-01	PVP iodine wipes	10	1	1	2	2
NORM75-25-77	Scissors, angled, red handle	1	1	-	-	-
NORM02-12-02	Sting relief wipes	10	-	1	1	2
NORM02-03-74	Triangular bandage	1	1	1	1	1



**A. First Aid Kits**

Kits contain economic bulk supplies that can be readily accessed when needed. They are ideal for manufacturing settings where a wide variety of first aid items are required. All kits are weatherproof and available in metal or plastic. ANSI Z308.1 – 2003 compliant.

SKU	Description	UOM	Price
NORM01-97-03	First aid kit, 25 person, metal	EA	\$34.35
NORM019705	First aid kit, 50 person, metal	EA	\$63.14
NORM019707	First aid kit, 75 person, metal	EA	\$85.54

Refill Item #	Description	25 Unit	50 Unit	75 Unit
NORM03-20-72	Adhesive bandage, 1" x 3", plastic	32	100	100
NORM02-08-55	Adhesive bandage, fingertip, cloth	3	4	8
NORM02-00-20	Adhesive bandage, knuckle, cloth	2	3	6
NORM02-09-15	Adhesive bandage, extra large, plastic	1	2	3
NORM02-04-45	Adhesive tape, 1/2" x 2-1/2 yd.	2	2	3
NORM02-16-45	Antiseptic wipes, BZK	6	12	12
NORM04-50-28	Conforming bandage, 2" x 6 yd., non-sterile	2	3	4
NORM04-50-29	Conforming bandage, 3" x 6 yd., non-sterile	1	2	2
	CPR Filtershield™	1	1	1
NORM04-19-60	Elastic bandage, 2"	-	1	1
NORM03-14-00	Eye pad, sterile	1	2	3
NORM02-01-35	First aid/burn cream with aloe	6	12	12
NORM04-50-27	First aid guide	1	1	1
	Forceps, pointed, plastic	1	1	1
NORM02-06-67	Instant Cold Pak	1	2	2
NORM02-05-55	Pain-A-Rest®, non-aspirin	3	6	6
NORM75-25-77	Scissors, angled, red handle	1	1	1
NORM02-01-26	Antibiotic ointment pouch	6	12	12
	Sterile gauze pads, 2" x 2"	4	10	10
NORM03-20-16	Sterile gauze pads, 3" x 3"	1	2	10
NORM02-12-02	Sting relief wipes	6	12	12
	Trauma pad, 5" x 9", sterile	1	1	1
	Triangular bandage, non-sterile	1	1	1



**B. First Aid Stations**

First aid stations provide the largest quantity and assortment of first aid supplies for most minor injuries aches and pains. Ideal for large office or manufacturing settings, they offer a large supply of medicinals for cold relief from pain and indigestion. All stations contain CPR barriers and trauma dressings. ANSI Z308.1-2003 compliant.

SKU	Description	UOM	Price
NORM019720	First aid station, 100 person	EA	\$149.87
NORM019721	First aid station, 150 person	EA	\$215.62
NORM019722	First aid station, 200 person	EA	\$318.22

Refill Item #	Description	Pieces Per	100 Unit	150 Unit	200 Unit
NORM03-20-72	Adhesive bandage, 1" x 3", plastic	100	1	2	2
NORM03-21-76	Adhesive bandage, extra large, plastic	25	1	1	1
NORM04-80-07	Adhesive tape, 1/2" x 5 yd., spool	1	1	2	2
	Adhesive tape, 1" x 5 yd., spool	1	-	1	1
NORM02-10-47	Alcohol prep pads	10	2	3	4
NORM02-01-25	Antibiotic ointment	10	1	2	3
NORM03-22-03	Antiseptic pump spray, 2 oz.	1	-	1	1
NORM03-22-04	Burn pump spray, 2 oz.	1	1	1	1
	Cherry cough drops, 50 per carton	50	-	1	1
NORM04-50-28	Conforming bandage, 2" x 6 yd., non-sterile	1	4	5	10
NORM04-50-29	Conforming bandage, 3" x 6 yd., non-sterile	1	4	5	10
NORM12-10-55	CPR Microshield® w/ 1 pair gloves & wipes	1	1	1	1
	Elastic bandage, 2"	1	1	1	2
NORM02-03-00	Eye dressing pads with adhesive strips	4	1	1	1
NORM03-21-73	Fingertip bandage, cloth	50	1	1	1
NORM04-50-27	First aid guide	1	1	1	1
	Forceps, pointed plastic	1	1	1	1
NORM02-06-45	Gauze compress, 1 square yd.	1	1	1	1
NORM02-06-67	Instant Cold Pak	1	-	2	3
NORM03-21-75	Knuckle bandage, cloth	50	1	1	1
NORM04-80-04	Non adherent pads, 2" x 3"	10	2	3	3
NORM03-20-82	Pain-A-Rest®, non-aspirin	100	1	1	-
NORM03-20-92	Pain-A-Rest®, non-aspirin	200	-	-	1
NORM03-20-04	PVP iodine wipes	100	-	-	1
	Quick stop bandage	1	1	1	1
NORM75-25-77	Scissors, angles, red handle	1	1	1	1
NORM03-20-16	Sterile gauze pads, 3" x 3"	25	1	1	1
	Sterile gauze pads, 2" x 2"	10	1	1	2
	Triangular bandage, non-sterile	1	1	2	3

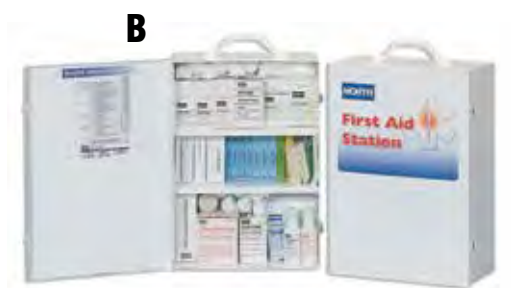

# First Aid/Medical

## Burn Care

These Burn Kits have been assembled to include the Water-Jel® Sterile Burn Dressings in the sizes your industry needs most. Also included in each kit are unit dose packets of Burn-Jel for minor spot burns.



**A**

### A. Industry Specific Burn Kits

SKU	Description	UOM	Price
WJWK-5	Water-Jel industrial & welding burn kit	EA	\$71.37

Description	Industrial	Food
Burn dressing, 2" x 6"	2	2
Burn dressing, 4" x 4"	2	2
Burn dressing, 4" x 16"	1	-
Burn dressing, 8" x 18"	1	-
Burn dressing, 12" x 16" face mask	1	1
Burn-Jel, 25 Packets	1	1
Elastic bandage	1	1
Instruction card	1	1

### B. Small Soft Sided Burn Kits

SKU	Description	UOM	Price
WJEBK1-6	Small soft sided burn kit in heavy duty carry case	EA	\$74.19

Description	Quantity
Burn dressing, 4" x 4"	2
Burn dressing, 4" x 16"	2
Burn dressing, 12" x 16" face mask	1
Roll gauze, 3"	2
Instruction card	1



**B**



**C**

### C. Large Soft Sided Burn Kits

SKU	Description	UOM	Price
WJEBK2-3	Large soft sided burn kit in heavy duty carry case	EA	\$144.47

Description	Quantity
Burn wrap 36" x 30"	1
Burn dressing, 12" x 16" face mask	1
Burn dressing, 8" x 18"	1
Burn dressing, 4" x 16"	1
Burn dressing, 4" x 4"	3
Roll gauze, 3"	4
Scissors	1
Instruction card	1

### D. Industrial Emergency Burn Station

SKU	Description	UOM	Price
WJEBSL-5	Industrial emergency burn station	EA	\$585.91

Description	Quantity
Burn dressing, 4" x 4"	2
Burn dressing, 4" x 16"	2
Burn dressing, 8" x 18"	1
Burn dressing, 12" x 16" face mask	1
3.5g unit dose packets of Burn Jel	10
2oz Burn Jel bottle	1
Roll gauze, 3"	2
Scissors	1
Instruction card	1



**D**

**A. Burn Jel®**

Unlike petroleum products that can actually trap the heat in a burn, this water-based, water-soluble gel actually draws the heat away from the skin and dissipates it on contact. It relieves pain fast and cools and soothes the affected area. Contains 2% lidocaine

SKU	Description	UOM	Price
WJ100U-6	Water-Jel Burn Jel, unitized 6/BX	EA	\$4.30
WJ600U-1	Water-Jel Burn Jel, unit doses 3.5 gm 25/BX	BX	\$17.54
WJ144-1	Water-Jel Burn Jel, 4 oz. squeeze bottle	EA	\$5.84



**B. Cool Jel**

This topical cooling gel cools and soothes minor burns, sunburns, scalds, cuts and abrasions. Water-based and water-soluble, it won't stick to a wound and can be easily rinsed away. Cool Jel also forms a protective barrier to help protect the wound from airborne contaminants that may delay healing.

SKU	Description	UOM	Price
WJCJ-6	Cool Jel 6/BX	BX	\$2.49
WJCJ-25	Cool Jel unit dose 25/BX	BX	\$10.45
WJCJ4-24	Cool Jel 4 oz squeeze bottle	EA	\$4.40

**C. Burn Dressings**

Water-Jel® Sterile Burn Dressings are soaked in a water-based, water-soluble gel to relieve the pain, cool the burn and protect against airborne contamination all-in-one easy step. The sterile burn dressings consist of a medical grade non-woven polyester soaked in a water-based, water-soluble gel and are available in six convenient sizes. The dressings can be placed directly over clothing, and the gel is easily removed with sterile saline.

SKU	Description	UOM	Price
WJ0206-60	Water-Jel Burn Dressing - sterile 2" x 6"	EA	\$3.47
WJ0404-60	Water-Jel Burn Dressing - sterile 4" x 4"	EA	\$4.33
WJ0416-28	Water-Jel Burn Dressing - sterile 4" x 16"	EA	\$8.64
WJ0818-20	Water-Jel Burn Dressing - sterile 8" x 18"	EA	\$12.71
WJ1216-20	Water-Jel Burn Dressing - sterile face mask 12" x 16"	EA	\$16.77
WJ0820-20	Water-Jel Burn Dressing - sterile for hand burns 8" x 20"	EA	\$16.77







**A**

### A. Burn Wrap

Water-Jel® Burn Wraps offer one of the quickest, easiest and most direct methods of administering emergency first aid burn care. When placed on a victim, gel-soaked wraps ease the pain, cool the burn, and help protect against airborne contamination all-in-one easy step. They can also be used to extinguish flames on a victim and put out small fires. The wraps are composed of a 100% worsted wool carrier capable of absorbing up to 12x its own weight. The wool is soaked in a water-based, water-soluble gel that is bacteriostatic and biodegradable. Five year shelf life.

SKU	Description	UOM	Price
WJP3630-4	Water-Jel Burn Wrap 3 ft x 2.5 ft in pouch	EA	\$68.90
WJ3630-4	Water-Jel Burn Wrap w/canister 3 ft x 2.5 ft	EA	\$68.90

### B. Fire Blanket

Water-Jel® Fire Blankets are soaked in a water-based, water-soluble gel to relieve pain, cool the burn, and protect against airborne contamination all-in-one easy step. The fire blankets consist of a 100% worsted wool blanket with intercellular weave. In addition to being a one-step burn care product, they can also be used to put out small fires, extinguish flames on a victim, and protect a rescuer from heat and flame. The blankets can be placed directly over clothing, and the gel is easily removed with sterile saline. Five year shelf life.

SKU	Description	UOM	Price
WJ7260-4	Water-Jel Fire Blanket Plus w/canister 6ft x 5ft	EA	\$163.16
WJP7260-1	Water-Jel Fire Blanket Plus 6 ft x 5 ft in pouch	EA	\$163.16



**B**



**C**

### C. Heat Shield

The Water-Jel® Heat Shield protects a rescuer from heat and flame, put out small fires and extinguish flames on a victim. In addition to providing protection from flames, it is soaked in a water-based, water-soluble gel to relieve pain, cool the burn, and protect against airborne contamination when applied to burnt skin. The blankets can be placed directly over clothing, and the gel is easily removed with sterile saline. Five year shelf life.

SKU	Description	UOM	Price
WJ9672-4	Water-Jel Heat Shield w/canister 8 ft x 6 ft	EA	\$239.04

### D. Water-Jel® Mounting Brackets

This mounting bracket holds the Water-Jel® canisters, allowing for easy access in emergency situations.

SKU	Description	UOM	Price
WJTL-10	Water-Jel steel mounting brackets TL10 for 9672-4	EA	\$63.16
WJTM-10	Water-Jel steel mounting brackets TM10 for 7260-4	EA	\$60.96

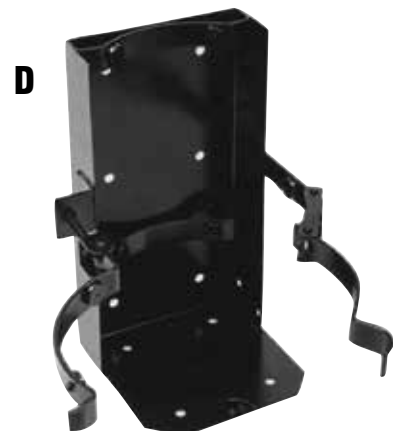

**D**

### A. Itch Relief Spray

Economical 2 oz. spray. External analgesic that provides temporary relief for insect bites, minor rashes due to poison ivy, oak, & sumac. Maximum strength formula.

SKU	Description	UOM	Price
WJAI2-24	Itch relief spray 2 oz.	EA	\$2.63

**A**



**B**

### B. Hydrogen Peroxide Spray

Economical 2 oz. spray. Irrigates and cleanses wounds. First aid antiseptic treatment for minor cuts & scrapes.

SKU	Description	UOM	Price
WJHP2-24	Hydrogen peroxide spray 2 oz.	EA	\$2.27

### C. Burn Spray

A water based spray that draws the heat out of the skin as it relieves the pain of minor burns.

SKU	Description	UOM	Price
WJBS2-24	Burn spray 2 oz.	EA	\$2.46

**C**



**D**

### D. Antiseptic Spray

For use on minor cuts, scrapes, and burns, this spray contains benzalkonium chloride to help prevent infection.

SKU	Description	UOM	Price
WJAS2-24	Antiseptic spray 2 oz.	EA	\$2.35

### E. WoundSeal™ Powder

When you have a bleeding injury, you want more than relief, you want immediate relief. That's what WoundSeal™ Powder delivers. Poured onto a bleeding cut or laceration, the revolutionary topical powder stops bleeding instantly while providing total wound care!

SKU	Description	UOM	Price
4768-2332	WoundSeal Powder Pour Pack	PK	\$6.38
4768-2333	WoundSeal Powder + Applicator for nosebleeds & hard to reach injuries	PK	\$7.66

**E**





**A**

### A. Antiseptic Spray

Antiseptic spray is a non-staining antiseptic that is used to relieve pain and prevent infection from minor cuts and burns.

SKU	Description	UOM	Price
4768-244-17	Antiseptic spray 3 oz pump spray bottle	EA	\$3.25

### B. Blood Clotting Spray

Aids in fighting infection, this spray is designed to stop the blood flow of minor cuts and scrapes on contact. Actually starts the clotting process.

SKU	Description	UOM	Price
4768-2226-17	Blood clotting spray 3 oz can	EA	\$6.64

**B**



**C**

### C. Burn Spray

This burn spray disinfects while relieving pain from minor burns, sunburns and abrasions.

SKU	Description	UOM	Price
4768-2213-17	Burn spray 3 oz can	EA	\$4.44

### D. Cold Spray

Cold Spray is used to cool the skin while reducing swelling and pain.

SKU	Description	UOM	Price
4768-2230-17	Cold spray 3 oz can	EA	\$3.83

**D**



**E**

### E. Calgonate, 2.5% Calcium Gluconate Gel

Calcium gluconate gel is a topical antidote for HF skin exposure.

SKU	Description	UOM	Price
PHA25G	Calgonate, 2.5% calcium gluconate gel 25 gm tube	EA	\$39.06

### F. Medi-Quik

Relieves pain associated with sunburn, insect bites, minor cuts and scratches, poison ivy and more.

SKU	Description	UOM	Price
6538-0102-11	Medi-Quik pump spray 3 oz can	EA	\$6.58

**F**





**A. Benadryl®**

For the temporary relief of pain and itching associated with insect bites, sunburn, minor cuts, minor burns, minor skin irritations, scrapes and rashes due to poison ivy, poison oak and poison sumac. Dries the oozing and weeping of poison ivy, poison oak and poison sumac.

SKU	Description	UOM	Price
1254-7171-67	Benadryl Maximum Strength 2% cream 1 oz tube	EA	\$6.32
0071-9501-15	Benadryl Maximum Strength 2% spray 2 oz	EA	\$7.97

**A**



**B**

**B. Caladryl®**

Temporarily relieves itching and pain associated with insect bites, minor skin irritations and rashes due to poison ivy, poison oak or poison sumac. Dries the oozing and weeping of poison ivy, poison oak and poison sumac.

SKU	Description	UOM	Price
0071-3181-19	Caladryl 6 oz lotion bottle	EA	\$7.32
0071-0311-80	Caladryl clear lotion 6 oz bottle	EA	\$7.32

**C. Foille®**

Foille medicated ointment is an external analgesic for the temporary relief of pain caused by minor burns, sunburn, insect bites, scrapes, cuts and minor skin irritations. Foille spray stops pain on contact and helps heal and prevent infection.

SKU	Description	UOM	Price
4138-3302	Foille ointment 1 oz tube	EA	\$3.82

**C**



**D**

**D. CalaGel®**

CalaGel is a multi-purpose medical gel. Cooling gel is very effective for rashes, bug bites, stings, sunburns and other minor skin irritations. CalaGel is an analgesic, antiseptic and skin protectant. Contains the popular sting relief ingredient menthol.

SKU	Description	UOM	Price
8392686000	Cala-Gel Clear 6 oz	EA	\$5.09

**E. Bactine**

Bactine kills germs as it soothes the pain and itch of minor cuts, scrapes and burns.

SKU	Description	UOM	Price
1650-0020-07	Bactine squeeze bottle 4 oz	EA	\$6.29

**E**





**A**

### A. Neosporin®

The #1 doctor recommended brand for over 25 years. First aid triple antibiotic to help prevent infection in minor cuts, scrapes and burns. Active ingredients in each gram: 400 units bacitracin, 3.5 mg neomycin and 5,000 units polymyxin B.

SKU	Description	UOM	Price
0081-0730-87	Neosporin ointment 1 oz tube	EA	\$10.72
0081-0730-58	Neosporin ointment individual package 144/BX	EA	\$50.62
0081-0711-88	Neosporin maximum strength plus cream .5 oz tube	EA	\$7.63

### B. Triple Antibiotic Ointment

3-in-1 first aid antibiotic ointment helps prevent infection from minor cuts, scrapes and burns.

SKU	Description	UOM	Price
WJTA-1728	Triple antibiotic ointment 1/32 oz unit dose packet 144/BX	BX	\$11.39
WJTA-1800	Triple antibiotic ointment 1/32 oz unit dose packet 25/BX	BX	\$3.53

**B**



**C**

### C. Bac-Neo-Poly Ointment

Fougera Bac-Neo-Poly Triple Antibiotic First Aid Ointment is an economical way to help treat minor cuts, scrapes and burns.

SKU	Description	UOM	Price
01680012-31	Bac-neo-poly ointment 1 oz	EA	\$5.96

### D. Polysporin®

First aid to help prevent infection in minor cuts, scrapes and burns. Doesn't contain neomycin sulfate. Active ingredients: 500 units bacitracin and 10,000 units polymyxin B.

SKU	Description	UOM	Price
0081-0798-87	Polysporin ointment 1 oz tube	EA	\$12.45

**D**



A



### A. Hydrocortisone

Temporarily relieves itching caused by minor skin irritations and rashes from insect bites, poison ivy and oak, exzema, soaps, detergents, jewelry and cosmetics.

SKU	Description	UOM	Price
WJHY1-1728	Hydrocortisone 1% 1/32 oz unit dose packet 144/BX	BX	\$15.58
01680015-31	Hydrocortisone 1% cream 1 oz tube	EA	\$2.40
WJHY1-1800	Hydrocortisone 1% Cream unit dose packet 25/Dispenser	BX	\$4.12

B



### B. First Aid Cream

The first aid cream with aloe vera offers antiseptic and pain relief for minor cuts, scrapes and burns. The cream contains aloe to moisturize the skin.

SKU	Description	UOM	Price
WJFA-1728	First Aid Cream with Aloe Vera, 1/32 oz unit dose packet 144/BX	BX	\$12.89
WJFA-1800	First Aid Cream with Aloe Vera, 1/32 oz unit dose packet 25/Dispenser	BX	\$3.45

### C. Bacitracin Antibiotic Ointment

Cheaper alternative to triple antibiotic. This first aid antibiotic ointment helps prevent infection in minor cuts, scrapes, and burns.

SKU	Description	UOM	Price
WJBA1800	Bacitracin antibiotic ointment, 1/32 oz unit dose packet 25/BX	BX	\$4.40
WJBA1728	Bacitracin antibiotic ointment, 1/32 oz unit dose packet 144/BX	BX	\$17.87

C



D



### D. Aquaphor® Healing Ointment

Aquaphor® Healing Ointment protects skin to help enhance the natural healing process. Non-irritating and fragrance-free.

SKU	Description	UOM	Price
7214-0452-31	Aquaphor healing ointment 1.75 oz	EA	\$6.60





**A**

### A. Vaseline®

Vaseline Petroleum Jelly heals dry skin, reduces the appearance of fine lines and wrinkles and removes eye make-up without irritation.

SKU	Description	UOM	Price
521-2345-00	Vaseline jelly jar 13 oz	EA	\$6.65

### B. Petroleum Jelly

A multi-purpose skin moisturizer and protectant made from oils and waxes. Soothes and moisturizes dry skin. Prevents chafing and windburn. Helps to protect against diaper rash.

SKU	Description	UOM	Price
0168-0053-45	Petrolatum white 5 gm foil pack 144/BX	BX	\$49.02
0168-0053-21	Petrolatum 1 oz tube	EA	\$4.11
0869-4629-10	Petrolatum jelly 13 oz jar	EA	\$4.15

**B**



**C**



### C. Zinc Oxide Ointment

Zinc oxide ointment soothes and protects the skin while promoting healing of skin irritations, diaper rash and sunburn.

SKU	Description	UOM	Price
01680062-31	Zinc oxide ointment 1 oz tube	EA	\$4.70



### MEDSAFE INFORMATION

We understand the details needed to make personalized program and product recommendations, our veteran outside and inside safety sales specialists can provide immediate solutions to your problems.

**A. Tinactin®**

Clinically proven to cure most athlete's foot (tinea pedis) and ringworm (tinea corporis). Helps prevent most athlete's foot from recurring when used daily. Effectively soothes and relieves symptoms of athlete's foot, including itching, burning and cracking. Contains tolnaftate 1%.

SKU	Description	UOM	Price
1101-7410-05	Tinactin Liquid Spray 5.3 oz	EA	\$8.25
0085-0715-05	Tinactin Cream 15 g	EA	\$9.13
0085-0444-06	Tinactin Super Absorbent Powder 3.8 oz	EA	\$8.52
0085-0254-06	Tinactin Powder Spray 4.6 oz.	EA	\$8.68

**A**



**B**



**B. Tolnaftate**

Effectively treats athlete's foot and ringworm, while relieving the itching, scaling, burning and discomfort associated with these conditions.

SKU	Description	UOM	Price
0168-0008-15	Tolnaftate cream 15 gm tube	EA	\$4.15
45802-034-86	Tolnaftate powder 45	EA	\$8.12

**C. Desenex®**

Desenex relieves itching, burning, cracking and scaling which accompany athlete's foot or ring worm conditions. Desenex is full prescription strength and is available in a variety of forms.

SKU	Description	UOM	Price
0067-0949-30	Desenex powder 3 oz	EA	\$8.78

**C**



**D**



**D. Anti-Fungal Cream**

For relief from the discomfort of athlete's foot, ringworm and jock itch; choose Medi-First® Anti-fungal Cream. Conveniently packaged in unit dose foil packets. Contains 1% tolnaflate.

SKU	Description	UOM	Price
MF229-35	Anti-fungal cream 1% 1/32 oz package 144/BX	BX	\$18.16

**E. Lotrimin AF**

Lotrimin AF Cream cures most athlete's foot (tinea pedis), jock itch (tinea cruris) and ringworm (tinea corporis). Relieves itching, burning, cracking, scaling and discomfort which can accompany these conditions.

SKU	Description	UOM	Price
0085-0963-15	Lotrimin AF cream 12 gm tube	EA	\$10.70

**E**





**A**

### A. Blue Gel

Blue Gel External Analgesic is a pain relieving gel for minor aches and pains of muscles and joints.

SKU	Description	UOM	Price
0536-2302-59	Blue Gel analgesic 8 oz	EA	\$5.68

### B. Mineral Ice®

This cool, greaseless pain reliever penetrates deep to provide fast, temporary relief of minor aches and pains associated with backache, strained muscles, arthritis and sprains.

SKU	Description	UOM	Price
5200-0001-02	Mineral Ice 16 oz jar	EA	\$18.07

**B**



**C**

### C. ICY HOT®

ICY HOT is the dual action topical pain reliever that cools to dull pain then heats up to relax the muscles. Ideal for fast pain relief from backache, muscle cramps, arthritis and stressed muscles. The combination of methyl salicylate and menthol is a must-have for any hardworking man or woman.

SKU	Description	UOM	Price
0025-2008-03	ICY HOT balm 3.5 oz jar	EA	\$7.72

### D. Thera-Gesic®

Temporarily relieve the pain of minor aches, sore muscles, and tender joints from bruises, sprains, arthritis and muscle strain. This penetrating balm is derived of 1% menthol and 15% menthyl salicylate.

SKU	Description	UOM	Price
0178-0320-05	Thera-Gesic balm 5 oz tube	EA	\$8.08
0178-0320-16	Thera-Gesic balm 16 oz bottle	EA	\$14.26

**D**





A



**A. Atomic Balm®**

Atomic Balm analgesic ointment is long-lasting petrolatum base for medium penetrating warmth.

SKU	Description	UOM	Price
CRA015538	Atomic Balm 1 lb jar	EA	\$30.65



B

**B. Biofreeze®**

Biofreeze, a unique, effective analgesic, provides fast-acting, long lasting pain relief. Other areas it can be beneficial are therapy, pain relief, exercise/training and overall comfort. Waxes, oils, aloe or petroleum are not included in the formula.

SKU	Description	UOM	Price
59316-100-00	Biofreeze .05 gm tube	EA	\$ .54
59316-3-00	Biofreeze 3 oz roll on	EA	\$9.25
59316-101-20	Biofreeze 4 oz bottle	EA	\$9.25
59316-16-00	Biofreeze 16 oz pump	EA	\$31.85
59316-32-00	Biofreeze 32 oz pump	EA	\$51.55
59316-128-20	Biofreeze gallon (128 oz)	EA	\$173.40

**C. BenGay®**

For the temporary relief of minor aches and pains of muscles and joints associated with simple backache, arthritis, strains, bruises and sprains. Light scent disappears as it penetrates. No staining or uncomfortable greasy feeling.

SKU	Description	UOM	Price
7430-0005-33	BenGay Vanishing Scent Gel 2 oz tube	EA	\$6.12

C



D



**D. Flexall 454®**

Flexall 454 is an aloe vera based pain relieving gel. Flexall provides fast long lasting pain relief for muscles and joints and penetrates the skin quickly. Flexall is greaseless and moisturizes and softens skin with vitamin E.

SKU	Description	UOM	Price
411687401	Flexall 454 16 oz bottle	EA	\$15.77
411687502	Flexall 454 7 lb bottle w/ pump	EA	\$92.55



**A**

### A. Cramer® Sports Rub™

Cramer Sports Rub Lotion helps make and keep muscles warm while providing soothing relief. The water-based formula lotion heats up with increased activity. Greaseless, stainless and has a pleasant mint fragrance.

SKU	Description	UOM	Price
CRA212936	Cramer Sports Rub lotion 1 gallon	EA	\$146.05

### B. Salonpas®

Salonpas, an external pain relieving patch, is for temporary relief of minor aches and pains of muscles and joints associated with arthritis, simple backache, strains, bruises and sprains. Each sheet measures 2.56" x 1.65"

SKU	Description	UOM	Price
MDHP0002	Salonpas pain relieving patches 40/BX	BX	\$5.75

**B**



**C**

### C. Muscle Jel

Highly effective therapeutic analgesic formulated for fast-acting relief of pain associated with back and muscle aches, arthritis, joint strains, sprains and bruises. A light, greaseless formula gel, that is also stainless because it is clear; it contains no blue or green coloring that can stain hands and clothing. With no lingering unpleasant odor, it is easily absorbed and provides long-lasting relief.

SKU	Description	UOM	Price
WJM24-576	Muscle Jel 3.5 gram unit dose packet 24/BX	BX	\$8.40
WJM1152	Muscle Jel 3.5 gram unit dose packet 96/BX	BX	\$31.01
WJM24-24	Muscle Jel 4 oz tube	EA	\$5.81
WJM16-6	Muscle Jel 16 oz pump bottle	EA	\$17.87
WJM32-4	Muscle Jel 32 oz pump bottle	EA	\$32.52

### D. Capsaicin Cream

Capsaicin cream temporarily relieves osteoarthritis, rheumatoid arthritis and neuralgic pain.

SKU	Description	UOM	Price
0182-5076-52	Capsaicin cream .025% 2 oz tube	EA	\$5.60

**D**



A



**A. APAP**

APAP is an aspirin-free tablet for temporary relief of pain and discomfort from colds, arthritis, headache, muscular aches, menstrual cramps and fever. Active ingredient: acetaminophen. Active ingredients: acetaminophen 325mg.

SKU	Description	UOM	Price
4768-2145-36	APAP tablets 325 MG AIDPAK 2 x 75	BX	\$5.26
4768-2145-13	APAP tablets 325 MG 2 x 250	BX	\$15.00

B



**B. APAP Extra Strength**

APAP Extra Strength is used for the temporary relief of minor aches and pains associated with headaches, muscular aches, minor arthritis pain, common cold, toothaches and menstrual cramps. Also used for the reduction of fever. Active ingredient: acetaminophen 500mg.

SKU	Description	UOM	Price
4768-2175-48	APAP Extra Strength 500 mg tablets 2 x 125	BX	\$11.08
4768-2175-13	APAP Extra Strength 500 mg tablets 2 x 250	BX	\$20.70

C



**C. I-Prin**

Temporary relief of aches and pains from arthritis, menstrual cramps, colds, headaches, toothache, muscular ache and for the reduction of fever. Active ingredients: ibuprofen 200mg.

SKU	Description	UOM	Price
4768-2100-47	I-Prin 200 mg 2 x 100	BX	\$9.62
4768-2100-13	I-Prin 200 mg 2 x 250	BX	\$22.83

D



**D. Mediproxen**

These easy-to-swallow micro-coated tablets contain naproxan sodium (220mg). Provides long lasting relief of pain and symptoms. Packaged in tamper-evident unit dose packets.

SKU	Description	UOM	Price
4768-2237-33	Mediproxen 220mg 100/BX	BX	\$16.31

**E. Back Pain-Off®**

Contains the maximum allowable dosage to alleviate back pain, inflamed joints, muscular aches and strains. Active ingredients: magnesium salicylate 290mg, acetaminophen 250mg, caffeine 50mg and total magnesium (19mg per tablet).

SKU	Description	UOM	Price
4768-073-33	Back Pain-Off 2 x 50	BX	\$8.44
4768-073-47	Back Pain-Off 2 x 100	BX	\$16.34
4768-2073-13	Back Pain-Off 2 x 250	BX	\$37.76







**A**

### A. Medi-Seltzer

Combines antacid with a pain reliever to stop pain. Ideal for temporary relief of headache, body aches, heartburn, indigestion and sour stomach. Active ingredients: aspirin 325mg, sodium bicarbonate 1,916mg and citric acid (in water) 1,000mg.

SKU	Description	UOM	Price
4768-135-24	Medi-Seltzer 72/BX	BX	\$11.47

### B. Diamode

Comparable to Imodium® AD, clinically proven to control and relieve the symptoms of non-specific diarrhea. Active Ingredient: 2 mg loperamide.

SKU	Description	UOM	Price
4768-2200-33	Diamode 2 mg 100/BX	BX	\$27.10

**B**



**C**

### C. Alcalak Antacid

This aluminum-free calcium supplement is ideal for heartburn, acid indigestion, sour stomach and upset stomach. Active ingredient: calcium carbonate 420mg.

SKU	Description	UOM	Price
4768-2101-33	Alcalak antacid 2 x 50	BX	\$5.10
4768-2101-13	Alcalak tablets 2 x 250	BX	\$22.85

### D. Diotame

Dio-Tame compares to Pepto Bismol and relieves indigestion and diarrhea. The liquid formula's active ingredient: is 524 mg bismuth subsalicylate. Active Ingredient: bismuth subsalicylate 262mg.

SKU	Description	UOM	Price
4768-2220-33	Diotame tablets 2 x 50	BX	\$10.02
4768-2220-13	Diotame tablets 2 x 250	BX	\$44.79

**D**



**E**

### E. Diphen

Diphen is sugar-free and salt-free and used for the relief of allergies and hay fever. Active ingredient: diphenhydramine HCL 25mg.

SKU	Description	UOM	Price
4768-2182-47	Diphen 25 mg 200/BX	BX	\$11.04

**A**



**A. Medi-Phenyl**

A sinus decongestant without the pseudoephedrine. Active ingredient: phenylephrine HCL 5mg.

SKU	Description	UOM	Price
4768-2205-13	Medi-Phenyl tablets 2 x 250	BX	\$22.27

**B**



**B. Medicidin-D**

Relieves symptoms of hay fever, cold, flu, allergies and sinus headache. Active ingredients: acetaminophen 325mg, chlorpheniramine maleate 2mg and phenylephrine HCL 5mg.

SKU	Description	UOM	Price
4768-2155-13	Medicidin-D tablets 2 x 250	BX	\$29.57

**C**



**C. Loradamed**

Great for allergy relief. Comparable to Claritin. Non-drowsy antihistamine. One 10 mg tablet is good for 24 hours. Active ingredient: loratadine 10mg.

SKU	Description	UOM	Price
4768-2203-50	Loradamed 1 x 50	BX	\$14.45

**D**



**D. Decorel Forte Plus**

Relieves congestion and nasal secretions that come with the common cold and other upper respiratory conditions. Active ingredients: acetaminophen 325mg, dextromethorphan HBR 15mg and guaifenesin 200mg.

SKU	Description	UOM	Price
4768-2425-33	Decorel Forte Plus 100/BX	BX	\$7.29

**E**



**E. Cold EEZE™**

Cold EEZE™ helps to reduce the duration and severity of common cold systems through its homeopathic formula. Contains a variety of flavors such as citrus, cherry, menthol eucalyptus, topical fruit and honey lemon. Homopathic Cold Remedy.

SKU	Description	UOM	Price
4768-458-73	Cold EEZE tablets 25/BX	BX	\$9.62



**A**

### A. CCP Caffeine Free Tablets

A non-drowsy tablet for temporary relief of symptoms associated with colds, allergies or flu. Active ingredients: acetaminophen 325mg, guaifenesin 200mg and phenylephrine HCL 10mg.

SKU	Description	UOM	Price
4768-2125-13	CCP Caffeine Free tablets 2 x 250	BX	\$37.14

**B**



### B. Chlorphen

For the relief of allergies and hay fever. Less drowsy. Active ingredients: chlorpheniramine maleate 4mg.

SKU	Description	UOM	Price
4768-2241-48	Chlorphen tablets 4mg 250/BX	BX	\$11.00



**C**

### C. Pain-Off®

Provides occupational strength pain relief from colds, headaches, toothaches, rheumatism and arthritis. Active ingredients: acetaminophen 250mg, aspirin 250mg and caffeine 65mg.

SKU	Description	UOM	Price
4768-2228-47	Pain-Off Extra Strength analgesic 2 x 100	BX	\$9.62
4768-2228-13	Pain-Off 2 x 250	BX	\$25.68

### D. Medikoff® Drops

Medikoff Drops are menthol-eucalyptus cough drops that temporarily relieve minor throat irritation due to coughs and colds. Active ingredient: menthol 7.6mg.

SKU	Description	UOM	Price
4768-2050-60	Medikoff Drops 600/BX	BX	\$39.89
4768-506-01	Medikoff Drops refill 600/BX	BX	\$29.03
4768-109-03	Medikoff menthol/eucalyptus sugar-free 300/BX	BX	\$30.96

**D**



**E**

### E. Medi-Lyte®

Medi-Lyte is an electrolyte replenishing tablet for fast relief of heat stress, fatigue and muscle cramping. Active ingredients: calcium phosphate 18mg, magnesium carbonate 9mg and potassium chloride 40mg.

SKU	Description	UOM	Price
4768-030-33	Medilyte tablets 2 x 50; 24 BX/CS	CS	\$117.70
4768-030-13	Medilyte tablets 2 x 250	BX	\$19.94



**A. Pain Relief**

Relieves headache, muscle aches, pains, menstrual cramps and fever. Active ingredients: acetaminophen 110mg, aspirin 162mg, caffeine 32.4mg and salicylamide 152mg.

SKU	Description	UOM	Price
MF811-33	Pain Relief 2 x 50	BX	\$3.57
MF811-48	Pain Relief 2 x 125	BX	\$7.62
MF811-13	Pain Relief 2 x 250	BX	\$15.04

A



B

**B. Aspirin**

Aspirin tablets are used to temporarily alleviate headaches, muscular aches, pain and fever. Active ingredient: aspirin 325mg.

SKU	Description	UOM	Price
MF805-33	Aspirin 325 mg 2 x 50	BX	\$2.85
MF805-48	Aspirin 325 mg 2 x 125	BX	\$5.64
MF805-13	Aspirin 325 mg 2 x 250	BX	\$11.04

**C. Non-Aspirin**

Gentle on the stomach Non-Aspirin relieves headaches, muscular aches, pains and fever. Aspirin-free. Active ingredient: 325 mg acetaminophen.

SKU	Description	UOM	Price
MF803-33	Non-Aspirin 325 mg 2 x 50	BX	\$3.26
MF803-48	Non-Aspirin 325 mg 2 x 125	BX	\$7.01
MF803-13	Non-Aspirin 325 mg 2 x 250	BX	\$12.42
MF804-33	Non-Aspirin Extra Strength 500 mg 2 x 50	BX	\$3.94
MF804-48	Non-Aspirin Extra Strength 500 mg 2 x 125	BX	\$8.79
MF804-13	Non-Aspirin Extra Strength 500 mg 2 x 250	BX	\$17.14

C



D

**D. Ibuprofen**

Comparable to Advil, Medi-First® ibuprofen comes in 200 mg tablets.

SKU	Description	UOM	Price
MF808-33	Ibuprofen 200 mg 2 x 50	BX	\$5.17
MF808-48	Ibuprofen 200 mg 2 x 125	BX	\$12.38
MF808-13	Ibuprofen 200 mg 2 x 250	BX	\$21.31

**E. Cramp Relief**

Cramp relief tablets provide fast relief for menstrual cramps. Active ingredients: acetaminophen 325mg and pamabron 25mg.

SKU	Description	UOM	Price
MF810-33	Cramp Relief tablets 2 x 50	BX	\$4.90
MF81048	Cramp Relief tablets 2 x 125	BX	\$10.21
MF810-13	Cramp Relief tablets 2 x 250	BX	\$20.18

E





**A**

### A. Antacid

This antacid is great for fast relief of heartburn, indigestion and sour stomach. Active ingredient: calcium carbonate 420mg

SKU	Description	UOM	Price
MF802-33	Antacid 420 mg 2 x 50	BX	\$3.39
MF802-48	Antacid 420 mg 2 x 125	BX	\$7.53
MF802-13	Antacid 420 mg 2 x 250	BX	\$13.73



**B**

### B. Cough Drops

These individually wrapped, cherry cough drops soothe the throat while relieving coughing. Active ingredients: menthol 7.6mg.

SKU	Description	UOM	Price
MF815-50	Cough Drops - cherry, 50/BX	BX	\$2.94
MF815-25	Cough Drops - cherry, indiv. packaged, 125/BX	BX	\$6.86



**C**

### C. Non-Pseudo Cold Relief

Multi-symptom formula relieves congestion, pain, coughs and fever. Contains 325 mg acetaminophen, 200 mg guaifenesin, 5 mg phenylephrine HCl and 15 mg dextromethorphan HBR.

SKU	Description	UOM	Price
MF822-33	Non-Pseudo Cold Relief 2 x 50	BX	\$5.45
MF822-48	Non-Pseudo Cold Relief 2 x 125	BX	\$13.10
MF822-13	Non-Pseudo Cold Relief 2 x 250	BX	\$25.35

**D**

### D. Non-Pseudo Sinus Pain & Pressure

Relieves sinus pressure associated with allergies, headaches and colds. Active ingredients: acetaminophen 500mg and phenylephrine HCL 5mg.

SKU	Description	UOM	Price
MF819-33	Non-pseudo Sinus Pain/Pressure 2 x 50	BX	\$5.52
MF819-48	Non-pseudo Sinus Pain/Pressure 2 x 125	BX	\$11.80
MF819-13	Non-pseudo Sinus Pain/Pressure 2 x 250	BX	\$20.56



**E**

### E. Non-Pseudo Sinus Decongestant

Quickly clears sinus pressure and congestion. Each tablet contains: Phenylephrine HCl 10mg.

SKU	Description	UOM	Price
MF809-33	Non-pseudo Sinus Decongestant 1 x 100	BX	\$5.91
MF809-13	Non-pseudo Sinus Decongestant 1 x 500	BX	\$23.15



**A. Advil®**

Ibuprofen tablets dull pain caused by headache, toothache, cramps, muscle aches and the minor pain of arthritis. Also an effective fever reducer. Active ingredient: 200 mg ibuprofen.

SKU	Description	UOM	Price
0573-0154-89	Advil 200 mg 2 x 50	BX	\$16.78
0573-0150-40	Advil 200MG tablets 100/BT	EA	\$16.53

A



B

**B. Motrin® IB**

Motrin IB provides fast, effective relief from headaches, muscle aches, minor arthritis pain, common cold and menstrual cramps while reducing fever. Active ingredient: 200 mg ibuprofen.

SKU	Description	UOM	Price
0009-0481-52	Motrin IB 200 mg 2 x 50	BX	\$17.63

**C. Tylenol®**

Tylenol Caplets are for temporary relief of minor aches and pains. They are effective against headaches, muscle aches, arthritis, common cold pains and menstrual cramps. Temporarily reduces fever. For use by adults and children over 12. Active ingredient: 500 mg acetaminophen.

SKU	Description	UOM	Price
0045-0449-10	Tylenol Extra Strength Caplets 2 x 50	BX	\$19.95

C



D

**D. Aleve®**

Temporarily relieves minor aches and pains due to: common cold, headache, toothache, muscular aches, backache, menstrual cramps, minor pain of arthritis. Temporarily reduces fever. Active ingredients: naproxen sodium 220mg.

SKU	Description	UOM	Price
0573-65999	Aleve 1 X 50	BX	\$19.98
2586-6105-02	Aleve caplets 220mg 24/BT	EA	\$5.95

**E. Bayer Aspirin®**

Fast acting Bayer Aspirin is recommended for temporary relief from headaches, colds, muscle aches and pains, menstrual pains, toothaches and minor aches and pains of arthritis and fever. Active ingredient: 325 mg aspirin.

SKU	Description	UOM	Price
1284-3101-14	Bayer Aspirin tablets 2500x2	BX	\$362.82
1284-3131-05	Bayer Aspirin Children Chewable 36/BX	BX	\$3.72

E



F

**F. Alka-Seltzer®**

For fast relief of acid indigestion, sour stomach with headache, heartburn and body aches and pains. Active ingredients: 325 mg aspirin, 1,916 mg heat treated sodium bicarbonate and 1,000 mg citric acid.

SKU	Description	UOM	Price
1650-4012-00	Alka Seltzer tablets 36/BX	BX	\$7.27
1650-4022-00	Alka Seltzer 72/BX	BX	\$13.75
1650-0505-88	Alka Seltzer Plus Cold & Flu 36/BX	BX	\$10.85
1650-0610-52	Alka Seltzer Plus Cold & Flu Liquigels 12/BX	BX	\$8.77





**A**

### A. Claritin® Tablets

Get powerful, non-drowsy, relief from your worst allergy symptoms. Claritin is the only brand proven to keep you as alert and focused as someone without allergies. Temporarily relieves runny nose, sneezing, itchy, watery eyes, and itchy nose or throat.

SKU	Description	UOM	Price
4110-0080-16	Claritin® Tablets 10MG tablet 10/BX	BX	\$18.95

### B. Robitussin® Cough Suppressant

Robitussin cough drops and syrup temporarily relieve minor throat irritations and cough due to colds or inhaled irritants. Active ingredient: guaifensin.

SKU	Description	UOM	Price
0031-8624-12	Robitussin syrup 4 oz bottle	EA	\$7.93
0031-8685-12	Robitussin DM syrup 4 oz bottle	EA	\$7.93
0031-8684-18	Robitussin DM syrup 8 oz bottle	EA	\$13.12

### Guiatuss Syrup

Comparable to Robitussin, guiatuss syrup is a decongestant that relieves cough.

SKU	Description	UOM	Price
0472-0061-16	Guiatuss plain syrup 16 oz bottle	BT	\$8.25
0472-0061-04	Guiatuss plain syrup 4 oz bottle	BT	\$3.07

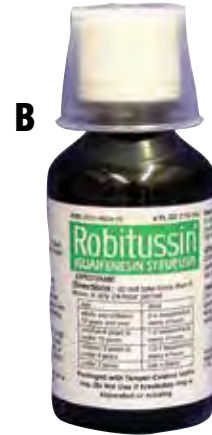

**B**



**C**

### C. Halls® Cough Lozenges

Halls with Advanced Vapor Action goes to work immediately to fight coughs, soothe sore throats and make nasal passages feel cooler. Active ingredient: 6.5 mg menthol.

SKU	Description	UOM	Price
1254-6628-69	Halls cough lozenges honey-lemon 30/BG	BG	\$2.55
1254-6627-49	Halls cough lozenges cherry 30/BG	BG	\$2.63
1254-6629-36	Halls cough lozenges menthol-eucalyptus 30/BG	BG	\$2.59

### D. Chloraseptic® Throat Lozenges

Temporarily relieves sore throat, sore mouth and minor mouth irritation with pain associated with canker sores. Cherry flavored. Active ingredients: 10 mg menthol and 6 mg benzocaine.

SKU	Description	UOM	Price
2390-0798-18	Chloraseptic lozenges - cherry 18/BX	BX	\$4.53

**D**



**E**

### E. Cepastat® Lozenges

Cepastat Sore Throat Lozenges provide fast-acting relief for severe sore throats. They are sugar-free lozenges with "phenol" as the active ingredient.

SKU	Description	UOM	Price
0068-0219-18	Cepastat cherry flavor lozenge 18/BX	BX	\$5.02

A



**A. Gelusil®**

For the relief of heartburn, sour stomach, acid indigestion and symptoms of gas. Active ingredients: 200 mg aluminum hydroxide dried gel, 200 mg magnesium hydroxide and 25 mg simethicone.

SKU	Description	UOM	Price
0071-0034-24	Gelusil tablets 100/BT	BT	\$10.48



B

**B. Pepto-Bismol® Products**

Pepto-Bismol provides soothing relief for upset stomach, indigestion, diarrhea, heartburn and nausea. Active ingredient: bismuth subsalicylate.

SKU	Description	UOM	Price
0149-0039-42	Pepto-Bismol 12 oz bottle	EA	\$7.95
0149-0039-16	Pepto-Bismol 16 oz bottle	EA	\$9.33
0149-0326-42	Pepto-Bismol tablets 48/BX	BX	\$10.08

**C. Imodium® AD**

Imodium AD provides fast, effective relief from diarrhea. Active ingredient: loperamide HCl.

SKU	Description	UOM	Price
0045-0295-06	Imodium AD 2 mg 6/BX	BX	\$4.88
0045-0295-12	Imodium AD 2 mg caplets 12/BX	BX	\$9.40

C



D

**D. Kaopectate®**

Kaopectate is an anti-diarrheal used to combat the symptoms of an upset stomach. Active ingredient: attapulgite.

SKU	Description	UOM	Price
0009-3785-01	Kaopectate regular flavor 8 oz	EA	\$6.72

**E. Antacid Liquid**

For everyday stomach problems. It provides effective relief from heartburn, acid indigestion, sour stomach and gas.

SKU	Description	UOM	Price
0113-0851-40	Antacid liquid 12 oz bottle	EA	\$3.40

E





**A**

### A. Tums®

For fast relief of acid indigestion, heartburn, sour stomach and upset stomach associated with these symptoms. Non-laxative, non-constipating. Active ingredient: calcium carbonate.

SKU	Description	UOM	Price
0766-0741-52	Tums fruit flavored 150/BT	EA	\$7.39

### B. Pepcid AC®

Just one Pepcid AC Acid Controller™ Tablet relieves heartburn and acid indigestion brought on by eating and drinking certain foods and beverages. Active ingredient: famotidine.

SKU	Description	UOM	Price
16837-872-30	Pepcid AC 10 mg 30/BX	BX	\$15.09



**B**



**C**

### C. Pepcid® Complete

Just one Pepcid® Complete chewable tablet start to neutralize acid in seconds and gives you heartburn relief that lasts all day or all night. With Pepcid® Complete, fast and long-lasting heartburn relief from a chewable tablet is now a reality!

SKU	Description	UOM	Price
16837-888-50	Pepcid Complete chewable tablets 50/BX	BX	\$27.98

### D. Zantac® 75

For the relief of heartburn, acid indigestion, and sour stomach. Active ingredient: ranitidine.

SKU	Description	UOM	Price
1254-7684-30	Zantac 75 30/BX	BX	\$14.00



**D**



**A. Chapstick®**

Cold, wind, sun. They all take a toll on your lips. That's why ChapStick is America's favorite lip balm. You see, ChapStick is serious protection for your lips. With a time tested formula that helps prevent and helps heal dry, chapped weather damaged lips. Take your pick of many great flavors: Regular, Cherry, Strawberry, Mint and PJP Plus. Don't go out without it!

SKU	Description	UOM	Price
0031-8125-00	Chapstick assorted lip balm 88/BX	BX	\$187.43
3660-8133-10	Chapstick regular stick	EA	\$2.02



A



B

**B. Carmex®**

Carmex helps to provide relief of the symptoms of cold sores and dry chapped lips.

SKU	Description	UOM	Price
8307-8113-17	Carmex Click Stick .15 oz	EA	\$1.52
0000-0751-00	Carmex jar 1/4 oz	EA	\$1.35

**C. Blistex®**

Blistex Lip Balm seals in moisture to prevent drying and chapping. Blistex glides on comfortably and has a SPF 15 rating. Blistex is recommended for protection from overexposure to the sun.

SKU	Description	UOM	Price
4138-2122	Blistex .21 oz tube	EA	\$2.45
4138-8312	Blistex .15 oz stick	EA	\$1.52



C



D

**D. Lip Guard**

Medi-First Lip-Guard contains 4 medications to provide relief from the pain, itching and discomfort of chapped or cracked lips. Compares to Blistex.

SKU	Description	UOM	Price
MF266-71	Lip Guard 20/BX	BX	\$2.10

**E. Orajel**

Orajel provides immediate relief of toothache pain. Orajel starts to work on contact, while pain pills take up to 30 minutes to work. Orajel is the #1 oral pain reliever for toothache.

SKU	Description	UOM	Price
1031-0222-13	Orajel .18 oz reg	EA	\$6.93
1031-0222-40	Orajel .33 oz gel	EA	\$7.30
1031-0283-13	Orajel maximum strength toothache pain relief gel .33 oz BX	EA	\$8.47



E



F

**F. Anbesol**

Anbesol gel temporarily relieves pain associated with the following mouth and gum irritations: toothache, sore gums, canker sores, braces, minor dental procedures, dentures.

SKU	Description	UOM	Price
0573-0218-07	Anbesol regular strength gel .25 oz	EA	\$7.62



**A**

### A. Debrox®

For occasional use as an aid to soften, loosen and remove excessive earwax.

SKU	Description	UOM	Price
0088-1021-05	Debrox drops 1/2 oz bottle	EA	\$7.67

### B. Swim-EAR®

Swim-EAR Drops help remove water in the ears and relieve the discomfort of water-clogged ears by drying excess water.

SKU	Description	UOM	Price
0168-7931-91	Swim-EAR 1 OZ Bottle	EA	\$5.00



**B**



**C**

### C. Ear Wax Removal Kit

The Murine Ear Wax Removal System is a complete, medically approved system to safely remove ear wax. The kit contains an ear syringe bulb plus fast-acting Murine Ear Drops to soften, loosen, and remove excessive ear wax. Ear drops also sold separately.

SKU	Description	UOM	Price
0074-7362-19	Murine ear wax removal system	EA	\$8.88

### D. Ear Drops

Murine Ear Drops are a doctor-recommended, fast-acting carbamide peroxide ear wax removal aid.

SKU	Description	UOM	Price
0074-7362-03	Murine ear drops .5 oz	EA	\$7.13



**D**

**A. Afrin®**

Afrin original 12 hour nasal spray temporarily relieves nasal congestion due to common cold, hay fever, upper respiratory allergies and sinusitis. Shrinks swollen nasal membranes so you can breathe more freely.

SKU	Description	UOM	Price
0085-0756-05	Afrin nasal spray 15 ml	EA	\$8.28

A

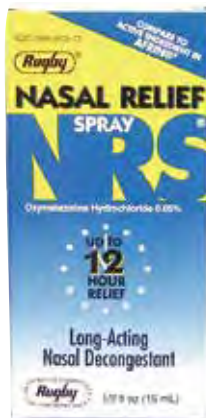

B

**B. Nasal Relief Spray**

Nasal Relief Spray is a long-acting nasal decongestant that provides up to 12 hours of relief. This oxymetazoline HCl .05% spray helps to relieve nasal congestion due to the common cold, hay fever or other respiratory allergies. Also helps to restore freer breathing through the nose.

SKU	Description	UOM	Price
0677-0831-30	Nasal Relief 1/2 oz	EA	\$7.53

**C. OCEAN® Premium Saline Nasal Spray**

Ocean Premium Saline Nasal Spray is for dry nasal membranes; squeeze twice in each nostril as needed. When the bottle is upright it delivers a spray; horizontally a stream; upside down a drop.

SKU	Description	UOM	Price
2560-1520-10	Ocean Premium Saline Nasal Spray 45CC bottle	EA	\$4.80

C



D

**D. Saline Nasal Spray**

Goldline Moisturizing Nasal Spray is used for dry nasal membranes. This soothing spray restores important moisture to comfort and soothe dry, irritated nasal passages due to colds, allergies, dry air (low humidity), air pollution and the overuse of nasal decongestants.

SKU	Description	UOM	Price
45802-317-58	Saline nasal spray 45 ml	EA	\$1.75





**A**

### A. Refresh® Celluvisc®

This thick gel formula provides extra strength moisturizing relief and protection in a preservative-free formula for sensitive eyes, Refresh Celluvisc is a preservative-free artificial tear that comes in convenient single-use containers and is safe to use as often as needed.

SKU	Description	UOM	Price
0023-4554-30	Celluvisc .4 ml ocular lubricant 1% 30/BX	BX	\$16.40

### B. Refresh® Optive™ Lubricant Eye Drops

Instantly moisturizes and relieves dry, irritated eyes with our original formula for sensitive eyes, Refresh Optive is a preservative-free artificial tear that comes in convenient single-use containers and is safe to use as often as needed.

SKU	Description	UOM	Price
0023-0506-01	Refresh Optive eye drops 30/BX	BX	\$14.05

**B**



**C**

### C. Refresh Plus® Eye Drops

Instantly moisturizes and relieves dry, irritated eyes with a fast-acting, long-lasting formula for sensitive eyes. Demonstrated to improve dry eye when used after lasik. Refresh Plus is a preservative-free artificial tear that comes in convenient single-use containers and is safe to use as often as needed.

SKU	Description	UOM	Price
0023-5487-50	Refresh Plus ophthalmic solution 50/BX	BX	\$23.79

### D. Advanced Eye Relief Rejuvenation

Advanced Eye Relief Dry Eye Rejuvenation Lubricant Eye Drops soothes, refreshes and comforts irritated, dry eyes. This formula contains two lubricants (glycerin and propylene glycol) that effectively moisturizes dry eyes and helps prevent further irritation. It replenishes tears and refreshes eyes for fast relief from age-related dry eyes. And it is safe and gentle enough to use as often as needed.

SKU	Description	UOM	Price
1011-9020-68	Bausch & Lomb Dry Eye Rejuvenation .15ML	BX	\$5.00

**D**



**A. Sensitive Eyes®**

Use Sensitive Eyes® Plus Saline Solution to rinse your soft contact lenses. The unique, gentle, pH-balanced formula contains potassium, an ingredient found in your own tears. Use for rinsing after daily cleaning and before insertion. Safe for rinsing before or after heat, chemical, and hydrogen peroxide disinfection. Use for diluting enzymatic cleaning tablets and storing soft contact lenses after thermal disinfection.

SKU	Description	UOM	Price
1011-9002-38	Bausch & Lomb Sensitive Eyes Plus 12 oz	EA	\$5.45

A



B

**B. Visine®**

For fast relief of redness of the eye due to minor irritation of eyes caused by conditions such as smoke, dust, other airborne pollutants and swimming. Active ingredient: tetrahydrozoline.

SKU	Description	UOM	Price
7430-0008-03	Visine 1/2 oz bottle	EA	\$6.75
4300-0003-08	Visine 1 oz bottle	EA	\$10.25

**C. Medic's Choice Eye Drops**

Replaces Murine and/or Visine Eye Drops for fast, soothing relief of tired and irritated eyes. Contains: tetrahydrozoline.

SKU	Description	UOM	Price
4768-2295-28	Medic's Choice eye drops 1/2 oz bottle	EA	\$3.28

C



D

**D. Eye-stream®**

Eye-stream solution provides first aid eye care in emergency situations involving foreign body removal or soothing chemical burns. The solution also can be used in irrigation after minor surgery or diagnostic procedures. Active ingredient: balanced saline solution.

SKU	Description	UOM	Price
0065-0530-04	Eye-stream solution 4 oz bottle	EA	\$46.96



**A**

### A. Collyrium Eye Wash

Collyrium eye wash loosens foreign particles trapped underneath the eye lid. Soothing to irritated eyes. Ideal for emergency flushing due to irritation or used to irrigate dry, red eyes.

SKU	Description	UOM	Price
0008-0769-01	Collyrium eye wash 4 oz bottle	EA	\$6.59

### B. Eye/Skin Irrigation Solution

FDA approved solution for irrigating the eye to help relieve discomfort, stinging, burning, or itching by removing loose foreign material, air pollutants or chlorinated water. Also approved as a skin wound cleaner for superficial wounds to aid in the removal of foreign materials such as debris or dirt.

SKU	Description	UOM	Price
4768-2198-28	Medi-Wash eye irrigant 1 oz bottle	EA	\$2.29
4768-2198-18	Medi-Wash eye irrigant 4 oz bottle	EA	\$2.40
MF215-08	Eye/skin irrigation solution 8 oz bottle	EA	\$4.00



**B**



**C**

### C. Eye Cups

Eye cups work great for direct flushing of the eye.

SKU	Description	UOM	Price
MF710-69	Eye Cups 6/Vial	VL	\$2.29
1065-1010-08	Eye cups 1/4 oz sterile 12/BX	BX	\$16.84

# Honeywell

### D. Eye & Skin Flush Station

Sterile, soothing, normal saline wash. Self-contained, easily installed stations that provide workers with immediate eye flushing in the event of an accident. Highly visible back plate.

SKU	Description	UOM	Price
FEN32000460	Eye and skin flush station, single, 16 oz	EA	\$25.22
FEN32000465	Eye and skin flush station, double, 16 oz	EA	\$38.18
FEN320004610	Eye and skin flush station, single, 32 oz	EA	\$28.49
FEN320004620	Eye and skin flush station, double, 32 oz	EA	\$42.38
FEN3200045EA	Eye and skin flush replacement bottle, 16 oz	EA	\$7.69
FEN32000455	Eye and skin flush replacement bottle, 32 oz	EA	\$10.69

**D**





### A. Eye Flush Set

Eye-Lert® Eyewash Solution. Sterile, solution 1 oz. with 2 eye pads & 4 adhesive strips per unit, double size.

SKU	Description	UOM	Price
NORM02-09-56	Eye wash with pads and strips, 1 oz	EA	\$3.67

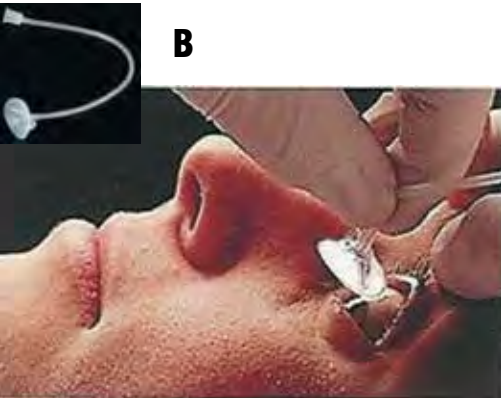

### B. Morgan® Lens

The Morgan Lens is the most effective method for treating ocular trauma. It is widely used by physicians, nurses and other medical personnel for emergency eye irrigation. In seconds, the eye can be receiving the lavage necessary to treat chemical and thermal burns or to remove non-embedded foreign materials in the eye. The Morgan Lens is designed to be attached to the Morgan Lens Delivery Set (or a standard IV setup) and an irrigation solution of choice. The patient can then be comfortably transported while receiving complete ocular irrigation, and medical personnel are free to concentrate on other injuries or other patients. Because of its effectiveness and efficiency, the Morgan Lens saves time, saves trouble ... saves eyes. All packaging and products are latex free.

SKU	Description	UOM	Price
MORMT2000	Morgan Lens	EA	\$35.53

### C. Morgan® Lens Delivery Set

It is very often the case that the pain in one eye masks pain in the second eye. Therefore, as soon as irrigation of a severely burned or irritated eye has begun, it is essential that a careful assessment of the other eye be done. Unless the other eye is completely comfortable and there is no pathology discovered, immediate irrigation should be started. The Morgan Lens Delivery Set consists of a specialized IV delivery set that can be attached to two Morgan Lenses, conveniently providing simultaneous irrigation of both eyes. Use of the Delivery Set saves time and money, since you do not need to use two separate IV setups. The rate of flow may be controlled, and irrigation to just one eye is possible since the necessary clamps are included. Latex free.

SKU	Description	UOM	Price
MORMT202	Lens delivery set 6/BX	BX	\$46.85



### D. Irrigating Solutions

The sterile solution in an irrigation comes in an Aqualite semi-rigid, shatter-proof container. The square bottle shape makes it easy-to-handle and eliminates rolling. The bottle is latex-free and available in 500 mL and 1000 mL sizes. **This item requires a prescription.**

SKU	Description	UOM	Price
0074-6139-03	Solution sterile water for irrigation 500 ml pour bottle	EA	\$2.84
0074-7139-09	Solution sterile water for irrigation 1000 ml pour bottle	EA	\$3.09
0074-6138-02	Solution sodium chloride 0.9% irrigation 250 ml pour bottle	EA	\$2.47
0074-6138-03	Solution sodium chloride 0.9% irrigation 500 ml pour bottle	EA	\$3.04
0074-7138-09	Solution sodium chloride 0.9% irrigation 1000 ml pour bottle	EA	\$3.09



**A**

### A. Dextrose

Dextrose solution comes complete and ready to use. It requires no refrigeration and is easy to assemble. **This item requires a prescription.**

SKU	Description	UOM	Price
0074-7517-16	Dextrose 50% 50 ml luer lock adapter tip no needle	EA	\$11.35
0074-7922-09	Solution dextrose 5% injection 1000 ml bag	EA	\$7.03
0074-7922-03	Solution dextrose 5% injection 500 ml bag	EA	\$7.03
0074-7926-09	Solution dextrose 5% with sodium chloride 0.45% 1000ml	EA	\$2.98

### B. Lactated Ringers

The lactated ringers solution injection bag comes complete and ready to use. It requires no refrigeration and is easy to assemble. Available in 500 mL and 1000 mL sizes. **This item requires a prescription.**

SKU	Description	UOM	Price
0074-7953-03	Solution lactated ringers injection 500 ml bag	EA	\$3.66
0074-7953-09	Solution lactated ringers injection 1000 ml bag	EA	\$7.03



**B**



**C**

### C. Sodium Chloride

The sodium chloride solution comes complete and ready to use. It requires no refrigeration and is easy to assemble. **This item requires a prescription.**

SKU	Description	UOM	Price
0074-7985-09	Solution sodium chloride 0.45% ing 1000 ml 12/CS	CS	\$46.26
0074-7983-02	Solution sodium chloride 0.9% injection 250 ml bag 24/CS	CS	\$53.32
0074-7983-03	Solution sodium chloride 0.9% injection 500 ml bag	EA	\$4.13
0074-7983-09	Solution sodium chloride 0.9% injection 1000 ml bag	EA	\$4.13
0074-7972-05	Solution sodium chloride 0.9% irrigation 1000 ml bag	EA	\$4.82

### D. Primary IV Set Minidrip with Flashball

This primary I.V. set is 70 inches long and has a convertible pin. **This item requires a pre-prescription.**

SKU	Description	UOM	Price
0074-1859-48	Primary IV set with prepierced injection site 15 DPS	EA	\$5.76



**D**



**E**

### E. IV Start Kit

The IV Start Kit contains everything you need to prep and secure an IV. The kit contains a Veni-Guard dressing, an alcohol prep pad, a 2 x 2 sterile sponge, a latex tourniquet and a povidone prep pad.

SKU	Description	UOM	Price
PROG0721	IV start kit (tour, PVP, tape, dress, label)	EA	\$2.98

### A. Protectiv IV Catheter

The Protectiv IV Catheter Safety System puts needle stick protection in your hands. Needle sticks account for more than a third of all hospital-related injuries and eighty percent of HIV/AIDS and HBV infections acquired on the job. Here's how it works: as you slide the catheter off the introducer needle, the protective guard glides into place over the needle. You are never exposed to a contaminated needle because the guard locks into place over the needle before the needle is removed from the catheter hub. A reassuring "click" lets you know the needle has been safely and permanently locked within the guard. No need to recap. No need to transport a contaminated needle. **This item requires a prescription.**

SKU	Description	UOM	Price
3460-JE3055	Protectiv IV catheter safety system J&J 18G x 1-1/4	EA	\$5.70
3460-JE3056	Protectiv IV catheter safety system J&J 20G x 1-1/4	EA	\$5.70



### B. Venicare® IV Catheter

### B. Venicare® IV Catheter

The Venicare line of IV catheters feature a thin taper, but don't sacrifice penetration force. This virtually eliminates catheter "curlback." **This item requires a prescription.**

SKU	Description	UOM	Price
0723381454	Catheter 16G x 1/16" insyte autoguard 50/bx	BX	\$226.93
0074-4532-20	Venicare IV catheter clear hub 20 x 1-1/4 EA	EA	\$2.40
0074-4535-08	Venicare IV catheter 18G x 1-1/4" EA	EA	\$2.40



### C. Butterfly IV Needles

The Hospira Venicare® system provides indwelling IV catheters with thin taper without sacrificing penetration force. Virtual elimination of catheter "curlback." **This item requires a prescription.**

SKU	Description	UOM	Price
0723368608	Vacutainer needle 22Gx 1-1/4" M/S SFTY 48	BX	\$41.33



### D. Winged Collection Set

### D. Winged Collection Set

BD Vacutainer® Winged Collection Set for collecting blood samples. **This item requires a prescription.**

SKU	Description	UOM	Price
0721367253	BD Vacutainer winged collection set 23G x 3/4" 50	BX	\$106.12







### A. BD SafetyGlide™ Syringe

BD Activation Assist™ technology allows fast and easy, single-handed needle shielding. Needle-based technology provides the greatest amount of versatility. Full array available. **This item requires a prescription.**

SKU	Description	UOM	Price
0723305905	3CC syringe BD SafetyGlide 23G x 1" 50/BX	BX	\$31.55
0723305906	3CC syringe BD SafetyGlide 22G x 1-1/2" 50/BX	BX	\$41.57
0723305904	3CC syringe BD SafetyGlide 25G x 5/8" 50/BX	BX	\$36.40
0723305903	1CC 25G x 5/8" safety syringe	BX	\$44.63
0723305945	1CC TB syringe BD SafetyGlide 27G x 1/2" 100/BX	BX	\$81.46

### B. BD SafetyGlide™ Needle

BD Activation Assist™ technology allows fast and easy, single-handed needle shielding. Needle-based technology provides the greatest amount of versatility. Full array available. **This item requires a prescription.**

SKU	Description	UOM	Price
0723305916	25G x 1" BD SafetyGlide needle only 50/BX	BX	\$30.31
0723305900	22G x 1" 1/2 BD SafetyGlide needle 50/BX	BX	\$30.95

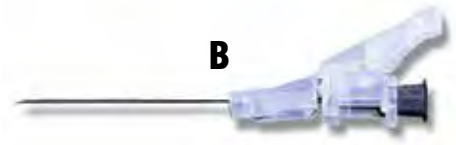

### C. BD Safety-Lok™ Syringe & Needle

The only safety-engineered syringe of its type to offer clear visual confirmation of the lock position. **This item requires a prescription.**

SKU	Description	UOM	Price
072330554	1CC 25G x 5/8" BD Safety-Lok syringe & needle 100/BX	BX	\$78.16
0723305559	10CC syringe only BD Safety-Lok with luer-lok tip 50/BX	BX	\$50.24
0723309592	3CC BD Safety-Lok syringe & needle 25G x 5/8" 100/BX	BX	\$45.24
0723309594	3CC 23 x 1" BD Safety-Lok syr/ndle 100/BX	BX	\$48.85
0723309593	3CC 22G x 1 -1/2" BD Safety-Lok syr 100/BX	BX	\$39.66

### D. VanishPoint® Syringe

The VanishPoint syringe features a one-hand operation that automatically retracts the needle. The needle retracts from the patient directly to the syringe barrel. The syringe design discourages reuse. **This item requires a prescription.**

SKU	Description	UOM	Price
10311	VanishPoint syringe 3CC 23G x 1" 100/BX	BX	\$76.14
10391	VanishPoint syringe 3CC 25G x 1" 100/BX	BX	\$109.05
10301	VanishPoint syringe 3CC 25G x 5/8" 100/BX	BX	\$107.38
10331	VanishPoint syringe 3CC 22G x 1" 100/BX	BX	\$162.61



### A. BD™ Syringe & Needle

Latex-free syringes. The world's sharpest needles. Quality from a name you can trust. **This item requires a prescription.**

SKU	Description	UOM	Price
0723309570	3CC syringe & needle 25G x 5/8" 100/BX	BX	\$24.92
0723309571	3CC syringe & needle 23G x 1" 100/BX	BX	\$23.67
0723309572	3CC syringe & needle 22G x 1" 100/BX	BX	\$23.07
0723309574	3CC syringe & needle 22G x 1-1/2" 100/BX	BX	\$29.18
0723309575	3CC syringe & needle 21G x 1" 100/BX	BX	\$23.67
0723309581	3CC syringe & needle 25G x 1" 100/BX	BX	\$27.72
0723309630	5CC syringe & needle 22G x 1" 100/BX	BX	\$48.48
0723309632	5CC syringe & needle 21G x 1" 100/BX	BX	\$48.48



**B**



### B. BD™ Tuberculin Syringe & Needle

Tuberculin Syringe and Needle. 1cc syringe with a needle. Packaged in lots of 100. **This item requires a prescription.**

SKU	Description	UOM	Price
0723309626	1CC 25G x 5/8" tuberculosis syringe & needle 100/BX	BX	\$32.05
0723309623	1CC syringe & needle 27G X 1/2" 100/BX	BX	\$30.47

### C. BD™ Syringe

Latex-free syringes. Quality from a name you can trust. **This item requires a prescription.**

SKU	Description	UOM	Price
0723309651	30CC syringe only 40/BX	BX	\$53.60



**D**



### D. BD Luer-Lok™ Syringe

Syringes feature a transparent barrel with bold scale markings that are easy to read. These syringes also feature a BD Luer-Lok thread for an added secure connection. Syringes are latex-free. **This item requires a prescription.**

SKU	Description	UOM	Price
0723309603	5CC syringe only with BD Luer-Lok tip 100/BX	BX	\$36.37
0723309604	10CC syringe only with BD Luer-Lok tip 100/BX	BX	\$19.53
0723309653	60CC syringe only BD Luer-Lok 40/BX	BX	\$69.72

### E. BD™ Needles

The world's sharpest needles. Quality from a name you can trust. **This item requires a prescription.**

SKU	Description	UOM	Price
0723305195	18 gauge needle 1" 100/BX	BX	\$16.58
0723305196	18 gauge needle 1-1/2" 100/BX	BX	\$15.75
0723305175	20 gauge needle 1" 100/BX	BX	\$15.75
0723305176	20 gauge needle 1-1/2" 100/BX	BX	\$15.75
0723305165	21 gauge needle 1" 100/BX	BX	\$13.78
0723305167	21 gauge needle 1-1/2" 100/BX	BX	\$15.40
0723305155	22 gauge needle 100/BX	BX	\$13.78
0723305156	22 gauge needle 1-1/2" 100/BX	EA	\$15.40
0723305145	23 gauge needle 1" 100/BX	BX	\$13.78
0723305122	25 gauge needle 5/8" 100/BX	BX	\$14.63
0723305109	27 gauge needle 1/2" 100/BX	BX	\$15.40
8290-3051-36	27G 1 1/4 " needle only 100/BX	BX	\$23.68

**E**





**A**

### A. BD™ Allergist Tray

Allergist tray contains 25 syringes per tray. **This item requires a prescription.**

SKU	Description	UOM	Price
0723305539	Allergists tray 25/BX	BX	\$5.27

### B. BD Insulin Syringe & Needle

BD Ultra-Fine™ insulin syringes are comfortable and penetrate smoothly for a more comfortable injection. **This item requires a prescription.**

SKU	Description	UOM	Price
8290-3284-66	1/2CC insulin syringe Ultra-Fine 100/BX	BX	\$42.82



**B**



**C**

### C. BD Vacutainer® Safety-Lok™ Blood Collection Set

BD Vacutainer Safety-Lok Blood Collection Sets are indicated for both infusion and blood collection. They feature a translucent, integrated protective shield that helps prevent needle stick injuries by allowing one-handed activation immediately after use. The translucent shield allows the healthcare professional to visibly see any blood flashback. **This item requires a prescription.**

SKU	Description	UOM	Price
0723367281	Vacutainer safety-lok blood collection set 21G 3/4 50/BX	BX	\$109.98

### D. BD™ Vacutainer® Needle

The blood collection needle is a multi-sample needle featuring a safety shield that covers the needle immediately upon withdrawal from the vein. This helps prevent needle stick injuries. Proper activation of the needle is confirmed with an audible click. A simple way to safely collect blood samples. **This item requires a prescription.**

SKU	Description	UOM	Price
0721367210	Vacutainer needle 22X1 multiple sample 100/BX	BX	\$34.57



**D**



### A. Sharps Container

Sharps containers reduce the risk of accidentally sticking yourself with a needle by providing a hard plastic shell of dispose used sharps. These containers are leak-proof and puncture-resistant.

SKU	Description	UOM	Price
WIN184	Sharps container 1 gallon red	EA	\$6.27
WIN185	Sharps container 1.7 qt tall	EA	\$3.98
WIN182	Sharps container 6.2 qt medium	EA	\$6.78
WIN180	Sharps container 10 qt red large	EA	\$9.62
WIN187	Sharps container 23.0 qt	EA	\$12.95
WIN8705	Sharps container 32 qt Red (7.5 GA)	EA	\$15.83



A



B

### B. BD™ Sharps Container

BD brand sharps containers are convenient and functional. The container is durable, leak and puncture-resistant with a patented one-way funnel valve. Funnel valve helps to minimize needle sticks and prevents over-filling. Container is closable for easy disposal.

SKU	Description	UOM	Price
0723305487	Sharps container x-small 1.4 qt	EA	\$6.32
0723305488	Sharps container sm 3.3 qt	EA	\$8.45
0723305489	Sharps container med 6.9 qt	EA	\$11.59
0723305490	Sharps container lg 8.2 qt	EA	\$14.11
0723305477	Sharps Guardian 5 gallon with funnel top 8/CS	CS	\$197.81

### C. IN-ROOM® Sharps Container

Kendall In-Room Sharps Containers have an economical horizontal drop which maximizes container volume. A fill line is clearly displayed on both sides of the container. Brackets are available to ensure safety and compliance.

SKU	Description	UOM	Price
55948500-1	Inroom sharps container 2 qt, transparent red, always open lid	EA	\$7.72
55948513-1	Sharps disposal container 5 qt, transparent red, mailbox-style lid	EA	\$8.40



C

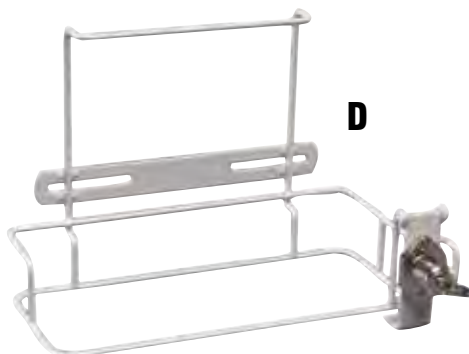

D

### D. Sharps Container Wall Bracket

These unobtrusive wall brackets hold the 2 and 5 quart Kendall In-Room Sharps containers securely in place. All brackets have a universal key for convenience.

SKU	Description	UOM	Price
55948519-C	Wall bracket sharps container, non-locking	EA	\$21.97
55948518C	Wall bracket sharps container with locking bracket	EA	\$23.11

### A. Trauma Kits

EMT Trauma Kits are multipurpose trauma kits. The contents are listed below.

SKU	Description	UOM	Price
HBZ1	Trauma kit	EA	\$234.07
HBZ2	Trauma kit with disposable resuscitator	EA	\$281.37
HBZ3	Trauma kit with respirator and oxygen	EA	\$387.12



Description	HBZ1	HBZ2	HBZ3
EMT Bag	1	1	1
Rescue Blanket, 56" x 84"	1	1	1
Sterile Burn Sheets	1	1	1
Blood Pressure Unit	1	1	1
Stethoscope	1	1	1
Utility Scissors	1	1	1
Kelly Forceps	1	1	1
Bite-Rite Stix	1	1	1
Oral Airway Kit	1	1	1
Pen Light	1	1	1
Full Arm Splint	1	1	1
Full Leg Splint	1	1	1
Povidone Iodine Swabs, 10	1	1	1
Eyewash, 1 oz.	1	1	1
Ammonia Inhalants, 10	1	1	1
Kwik Kold Kit	2	2	2
Kerlix Rolls, Sterile, 4-1/2"	1	1	1
Multi-Trauma Dressing, Sterile, 10" x 30"	1	1	1
Bloodstopper Dressing, Sterile	1	1	1
Triangular Bandage	2	2	2
Tourniquet Strap, 1" x 18"	1	1	1
Telfa Pads, Sterile, 3" x 4", 20	1	1	1
Kling, Sterile, 3"	2	2	2
Micropore™ Tape, 1" x 10 yd.	2	2	2
Surgipad 4" x 7-7/8"	4	4	4
Personal Protection Pack	1	1	1
Universal Precaution Kit	1	1	1
Perfit Extrication Collar	-	1	1
Manual Resuscitator	-	1	1
Lif-O-Gen Emergency Unit	-	-	1

### B. EMT Bag

This large trauma bag features a foam-padded interior and sidewalls for added protection and support. The interior pockets are adjustable, and the bag comes with a 2" heavy-duty strap. The bag has a 12" x 14" x 9" main hold, 12" x 3" x 5" side pockets and a 11" x 2" x 6" front pocket.

SKU	Description	UOM	Price
ERGB5215	Large trauma bag	EA	\$55.57



### WEB INFORMATION

For a full listing and online ordering visit our website at: [www.gosafe.com](http://www.gosafe.com)

**A. Burn Sheets**

GAM Sterile Burn Sheets are suitable for use in emergency burn and wound care until physician or hospital treatment is obtained. The sheet measures 60" x 96" and is made of sturdy, lint free, non-woven material.

SKU	Description	UOM	Price
262830-01	Burn sheets sterile	EA	\$6.72



**A**

**B**



**B. Body Bag**

This white vinyl body bag measures 90" x 36" and has a center zipper.

SKU	Description	UOM	Price
MEDNON70540W	Body bag 8 mil vinyl w/3id tag	EA	\$13.73

**C. First Aid Blanket**

The Junkin First Aid Blanket is warm and machine washable. It is excellent for indoor and outdoor general utility purposes, and is 70% wool, 30% man-made fibers.

SKU	Description	UOM	Price
JUNSAF-502	Blanket first aid 62 x 80 wool gray	EA	\$42.15



**C**

**D**



**D. Economy Blanket**

The Econo-Blanket is made of heavy, yellow poly with cellulose matting insulation. Works great as a ground tarp.

SKU	Description	UOM	Price
2628113-1	Blanket economy 54 x 80 disposable	EA	\$5.53





**A**

### A. Triangular Bandage

This non-sterile triangular bandage is made from strong muslin and comes with two safety pins.

SKU	Description	UOM	Price
262820-01	Triangular bandage polybagged	EA	\$ .87

### B. Multi-Trauma Dressing

CURITY® Multi-Trauma Dressings are ideal for virtually all first aid applications, including fractures, lacerations, wounds, abrasions and burns. They are effective as a pressure dressing to stop fluid loss.

SKU	Description	UOM	Price
35831967	Multi trauma dressing 10" x 30" sterile	EA	\$3.90



**B**



**C**

### C. Incision and Drainage Set

The incision and drainage set contains all necessary items for incision and drainage procedures. The set includes 1 18" x 26" poly-lined Fenestrated Drape, 1 poly-lined Towel, 1 plastic Bag with tie, 2 povidone-iodine prep pads, 4 cotton-filled sponges, 1 #11 blade scalpel, 1 5 1/2" straight hemostat, 1 Posi-Grip™ Thumb Forceps.

SKU	Description	UOM	Price
BUS758	Incision and drainage set	EA	\$7.47

### D. Laceration Tray

This tray includes everything needed to provide local anesthesia and suturing to a patient. The kit contains: One tray, one sterilization bag, one Kimguard wrap, one 10cc syringe, one 1 1/2" x 18g needle, one 1/2" x 27G needle, one 1/2" x 25G needle, five 2" x 2", 8-ply gauze, ten 4" x 4" 8-ply gauze, two medicine cups, two cloth OR towels, one cloth fenestrated drape, one Adson w/ 1x2 teeth, Iris scissors, Mosquito forceps, and a Webster needle holder.

SKU	Description	UOM	Price
5288-502192	Laceration tray #2 without suture	EA	\$22.85



**D**

**A. Arm Sling**

Sling envelops the arm for support and carries weight across back and shoulder. Slide buckle closure and web strap.

SKU	Description	Color	Size	UOM	Price
57381204D-S	Arm sling	Blue denim	S	EA	\$5.72
57381204D-M	Arm sling	Blue denim	M	EA	\$5.72
57381204D-L	Arm sling	Blue denim	L	EA	\$5.72
57381204D-XL	Arm sling	Blue denim	XL	EA	\$5.72



**A**



**B**



**B. Arm Sling**

Universal denim blue, envelope style arm sling that is made of a poly/cotton blend and has a deep pouch.

SKU	Description	UOM	Price
57381202W-L	Arm sling	EA	\$7.48

**C**



**C. Denim Universal Arm Sling with Pad**

Universal, denim blue, poly/cotton arm sling with pad. Envelope style with deep pouch. 1-1/2" wide cotton shoulder strap with pad is adjustable, and closes with hook and loop closure.

SKU	Description	Color	Size	UOM	Price
57381260-00	Denim universal arm sling with pad	Blue denim	Universal	EA	\$9.25



**D**

**D. Guardian Quik-Fit® Crutches**

The Quik-Fit Crutches feature a pushbutton footpiece adjustment allowing for quick, accurate fitting. The handle and height adjustments are in 1" increments for a more precise fit.

SKU	Description	UOM	Price
29176751112	Quik-Fit Crutches with accessories 5'1"-5'9"	PR	\$35.75
29176750112	Quik-Fit Crutches with accessories 5'10"-6'6"	PR	\$35.75



**A. HeartStart FR3**

The new HeartStart FR3 is Philips best professional-grade AED yet and is now making lifesaving faster, easier, better for professional responders.

As the smallest and lightest professional-grade AED available among leading global manufacturers\*, the HeartStart FR3 continues Philips legacy of providing AEDs that are designed to be rugged, reliable, and to support you every step of the way.

The HeartStart FR3 Defibrillator includes a Guide To Setup and Maintenance (printed); Instructions For Administrator's (CD); Battery (1); and SMART Pads III (1 set). The HeartStart FR3 Defibrillator includes a 5 year manufacturer's warranty at no charge. Battery includes a 3 year warranty; pads are warranted until expiration date. Other accessories (sold separately) include a 1 year warranty.

\* Data on file with Philips Healthcare.

SKU	Description	UOM	Price
PHI861388	HeartStart FR3 Text Bundle	EA	\$3160.59
PHI861389	HeartStart FR3 ECG Bundle	EA	\$3748.90
PHI861394	HeartStart FR3 battery charger	EA	\$350.05
PHI861467A01	HeartStart FR3 AED Trainer 3	EA	\$509.26
PHI989149971	HeartStart FR3 rigid system case	EA	\$274.39
PHI989149981	HeartStart FR3 Smart Pads III, 1 set	EA	\$51.94
PHI989150011	HeartStart FR3 pad sentry insert	EA	\$44.04
PHI989150161	HeartStart FR3 primary battery	EA	\$304.88

**B. HeartStart FRx**

The Philips HeartStart FRx Defibrillator is designed to be easy to use, rugged and reliable for those who get there first. On the scene with law enforcement, on the field with student athletes or on the job with employees, the FRx Defibrillator is the solution for treating Sudden Cardiac Arrest (SCA) from ventricular fibrillation in environments and conditions too demanding for many other defibrillators. Features include CPR Coaching and intuitive icon-driven operation.

SKU	Description	UOM	Price
PHI861304	HeartStart FRx Defibrillator	EA	\$2209.47
PHI989803132	HeartStart FRx smart pads	PR	\$63.23
PHI989031397	HeartStart FRx training pads II	PR	\$94.85
PHI989803133	HeartStart FRx infant/child key	EA	\$122.12
PHI989803139	HeartStart FRx carrying case	EA	\$154.74



**C. HeartStart OnSite - OTC**

The HeartStart OnSite is a small and lightweight defibrillator that can be easily carried to the victim's side. Using clear, calm voice instructions, the OnSite Defibrillator guides you, the first caregiver on the scene, through each step of defibrillation and CPR coaching. Integrated SMART Pads placed on the victim's bare skin transmit information to the defibrillator, which senses and adapts to your actions every step of the way. This defibrillator comes with a battery and one sets of pads and carrying case.

SKU	Description	UOM	Price
PHIM5066AC01	HeartStart Onsite AED w/battery, 1 set of pads & std. case	EA	\$1528.05
PHIM5066AC02	HeartStart Onsite AED w/battery, 1 set of Pads & slim case	EA	\$1458.74
PHIM5085A	HeartStart Onsite trainer	EA	\$404.25
PHIM5071A	HeartStart Onsite adult smart pads HS1	PR	\$75.66
PHIM5073A	HeartStart Onsite adult training pads	PR	\$94.85
PHIM5072A	HeartStart Onsite infant/child smart pads	PR	\$121.95
PHIM5070A	HeartStart Onsite replacement battery HS1	EA	\$190.83





**A. Zoll® AED Plus Unit with Prescription**

Now fully 2010 Guidelines-compliant! When a cardiac arrest occurs, the fact is that only half of the victims will need a shock. The other half requires high-quality cardiopulmonary resuscitation (CPR). You deserve an automated external defibrillator (AED) that helps you all the time, one that can actually see when you are doing CPR and provide help. You need more than just commands without assistance. That's not smart, and it's certainly not help. Only ZOLL's AED Plus® features Real CPR Help,™ a tool that is able to actually see what you are doing and provide feedback to help you do it well. Audio and visual prompts help you rescue with confidence and clarity unmatched by any other AED.

SKU	Description	UOM	Price
ZOL222000101	AERD Plus with Graphical CVR, Pads and Batteries	EA	\$2194.16



ALLE4210-01



ALLE4210-S



**D. AED Wall Cabinet**

Metal case comes in corrosion resistant electro-static white finish. Defibrillator graphics are dominantly displayed. Other features include a 13" x 13" window on door front, right hand door opening and recessed handle. Also included is a battery operated alarm. Includes metal shelf. The 4210-S has a battery operated audio alarm and fully sealed water-proof strobe. Exterior: 20-1/4"W x 9-1/4"D x 20-1/4"H. Interior: 20-18"W x 8-3/4"D x 20"H.

SKU	Description	UOM	Price
ALLE4210-01	AED wall cabinet small with alarm	EA	\$296.49
ALLE4210-S	AED wall cabinet small with alarm and strobe	EA	\$324.56



**MEDSAFE INFORMATION**

We understand the details needed to make personalized program and product recommendations, our veteran outside and inside safety sales specialists can provide immediate solutions to your problems.



**A**

### A. CPREzy™ CPR Assistance Device

The CPREzy CPR Assistance Device is unlike other manual External Chest Compression Assist Devices (ECCAD). Just turn it on, place it to the chest as suggested and begin compressing. There is no waiting for voice prompts which divert your attention and waste precious rescue time. Furthermore, the CPREzy ensures you are giving correct compression depths regardless of the surface that your victim is laying upon.

SKU	Description	UOM	Price
CPREZ01	CPREzy CPR Assistance Device	EA	\$214.04



### B. CPR Microshield®

For more than a decade the CPR Microshield has been the leader in CPR barriers. Designed to protect the rescuer while aiding in the administration of proper CPR technique, it has become the standard by which others are judged. The positive one-way valve inside the airway enhancing bite block is designed for maximum protection of the first responder. It also assists in keeping an open airway while performing the head-tilt, chin-lift maneuver.

SKU	Description	UOM	Price
431070150	Reusable CPR microshield, orange pouch	EA	\$6.46
431070155	CPR Microshield - sealed tamper resistant	EA	\$6.97
431070160	CPR Microshield - sealed with gloves	EA	\$7.99



**B**



**C**

### C. CPR Microkey-Pro®

Designed for rescuers who require the use of protective gloves, the CPR Microkey-Pro offers the personal protection of disposable nitrile gloves packaged with the CPR Microshield®.

SKU	Description	UOM	Price
431072490	CPR Microkey-Pro Shield with gloves	EA	\$9.79

### D. Laerdal® Face Shields

The Laerdal patient face shields help prevent direct contact with the patient's mouth, nose and face. It's plastic sheet and 3M Filtrete™ hydrophobic filter helps to reduce risk of blood or saliva contact between rescuer and patient. The shield features a bi-directional filter and imprinted graphic directions.

SKU	Description	UOM	Price
LAE460001	Resuscitator patient face shields 10's	BX	\$25.00

**D**



### A. CPR Microkey™

The MDI CPR Microkey offers the protection of the finest barrier device available with the convenience of a key chain. An important factor in being prepared to save a life is to always have your barrier device with you. The compact pouch is made of durable nylon with a hook and loop closure and is available in two attractive colors.

SKU	Description	UOM	Price
431070190	CPR Microkey black	EA	\$9.19
431070192	CPR Microkey orange	EA	\$9.19



**B**



### B. CPR Micromask™

The CPR Micromask features a positive one-way, non-re-breathing valve complete with filter. This valve has a large opening to reduce restrictive rescue breathing. The CPR Micromask is made of materials that remain flexible over a wide range of temperatures, allowing it to conform to facial contours and provide an outstanding seal, even under extreme conditions. The dome is manufactured from clear plastic for accurate patient monitoring. It may be used on adults, children and infants.

SKU	Description	UOM	Price
431073401	Single use CPR Micromask with gloves	EA	\$12.92

### C. AED First Responder Kits

AED First Responder kits allow the rescuer to administer proper CPR using the finest barrier or mask available. Additional components increase the level of protection while enabling the rescuer to efficiently dispose of all components.

SKU	Description	UOM	Price
431078700	AED first response kit with Microshield polybag	EA	\$13.73
431078800	AED first response kit with Micromask polybag	EA	\$20.70
431078820	AED first response kit with Micromask zip bag	EA	\$26.07



**D**



### D. CPR Microholster™

When immediate access to your CPR Microshield is of primary concern, the CPR Microholster is the logical choice. The convenient, highly durable pouch and the CPR Microshield with one pair of disposable nitrile gloves makes the CPR Microholster the choice of those who wear their protection on their hip. The hook and loop belt pouch is ideal for police, EMT's, correctional officers or any professional responder.

SKU	Description	UOM	Price
431070185	CPR Microholster with gloves and shield	EA	\$13.70
431072-581	CPR Microholster XL with gloves & shield	EA	\$15.21

### E. Laerdal® Pocket Mask™

The Laerdal Pocket Mask with One-Way Valve with its one-way valve and 3M™ Filtrete™ hydrophobic filter allows for effective ventilations and provides outstanding user protection. The pre-inflated cuff allows for ease of application and provides an effective seal for adult, child or infant patients. The Laerdal Pocket Mask provides distance from the patient and allows the rescuer to see the chest rise and fall.

SKU	Description	UOM	Price
LAE820011	Laerdal Pocket Mask with One-way Valve	EA	\$17.89
LAE830011	Laerdal Pocket Mask with One-way Valve and Oxygen Inlet	EA	\$25.05







### A. Airway Kit

The Berman oral airway kit includes six smooth, reinforced white polyethylene airways. They are disposable. Includes sizes infant to x-large.

SKU	Description	UOM	Price
28671003787	Airway kit oral infant thru x-large berman, 6/BX	BX	\$5.15

### B. Adult Bite-Block

The one-piece, non-toxic, unbreakable adult Bite-Block stick depresses the tongue and provides airway for seizure patients. Individually packaged.

SKU	Description	UOM	Price
262870-04	Adult Bite-Block Stix individually wrapped	EA	\$1.15



### C. Endotracheal Tube

Sterile, graduated clear plastic Murphy tube used for airway intubation.

SKU	Description	UOM	Price
3371-1051-50	Endotracheal tube Murphy 5.5 mm	EA	\$3.03
3371-1051-60	Endotracheal tube Murphy 6.0 mm	EA	\$3.03
3371-1051-70	Endotracheal tube Murphy 7.0 mm	EA	\$3.03
3371-1051-75	Endotracheal tube Murphy 7.5 mm	EA	\$3.03
3371-1051-80	Endotracheal tube Murphy 8.0 mm	EA	\$3.03
3371-1051-85	Endotracheal tube Murphy 8.5mm	EA	\$3.03
3371-1051-90	Endotracheal tube Murphy 9.0 mm	EA	\$3.03

### D. Laerdal® V-Vac™ Manual Suction Unit

With a wide-bore intake valve and suction tube to minimize clogging, the V-Vac Manual Suction Unit is a small, lightweight unit perfect for first responders. The disposable one-piece suction tube and cartridge leaves no need for cleaning. The unit has an adjustment for high and low pressure suctioning, with the maximum suction exceeding 380mmHg. Peak air flow is over 70 liters per minute. The starter kit contains two disposable cartridges, catheter, adapter tip, double male connector and handle.

SKU	Description	UOM	Price
LAE985000	V-VAC starter kit	EA	\$190.70



### E. Laerdal® Compact Suction Unit

The Laerdal Compact Suction Unit packs a lot of value into a small machine. The versatile LCSU comes with built-in gauge and regulator for all suctioning applications, and a two-year limited warranty. Comes complete with a soft carry case and AC/DC powercords. Oral, nasal, and tracheal suction applications for infants through adults!

SKU	Description	UOM	Price
LAE880020	Suction unit w/gauge, regulator & canister	EA	\$893.45

### A. Laerdal® Little Anne™ Manikin

The Little Anne is a realistic, lightweight, adult CPR trainer that offers all the essential features for quality CPR training. The airway can be opened using the head tilt, chin lift or jaw thrust technique. It has compression “clicker” to assure adequate compression depth, a compression spring for consistent resistance. The Little Anne manikin also includes disposable airways equipped with a one-way valve. Pad that doubles as carrying case included.

SKU	Description	UOM	Price
LAE020020	Little Anne manikin with pad carry bag	EA	\$301.32



A



B

### B. Laerdal® Little Anne™ Replacement Lungs

The Little Anne disposable airways with one-way valve need to be changed only at the end of each class for maximum instructor convenience and student safety. The replacement airways come 24 to a box.

SKU	Description	UOM	Price
LAE020300	Little Anne replacement lungs 24/BX	BX	\$72.37

### C. Laerdal® Manikin Face Shields

These disposable plastic face shields have a low resistance filter that fits over the manikin’s face. Used in addition to disinfectant products it offers inexpensive extra barrier protection for students sharing a manikin. It also trains students in the use of Laerdal Face Shield for real life emergencies.

SKU	Description	UOM	Price
LAE151201-CS	Manikin face shields 6 RL x 36/CS	CS	\$85.53
LAE151201	Manikin face shields 36/BX	BX	\$14.25



C

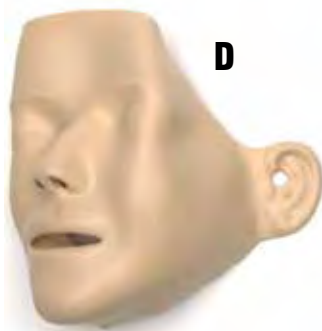

D

### D. Laerdal® Little Anne™ Replacement Faces

The Little Anne removable face mask can be used on a one-per-student basis, or continuously with normal disinfection between students. The face mask is realistic and has soft nostrils to make the nose easy to pinch. Fits on Resusci® Anne and Little Anne manikins.

SKU	Description	UOM	Price
LAE152004	Little Anne replacement faces 6/PK	BX	\$77.63



**A**

### A. Oxygen Mask

The adult mask is made of clear, soft vinyl for patient comfort and visual patient assessment. It features an adjustable nose clip to assure a correct fit.

SKU	Description	UOM	Price
32801007	Oxygen mask high concentration	EA	\$2.23
32801040	Oxygen mask with 7' tubing	EA	\$2.58
32801059	Oxygen mask non-rebreathing with 7 ft tubing	EA	\$2.38

### B. Nasal Cannula

The cannula with non-flared nasal tips is made of soft, transparent vinyl and has an adjustable elastic band for a comfortable, snug fit below the ears.

SKU	Description	UOM	Price
32801100	Nasal cannula oxygen with tubing one use	EA	\$3.18
32801104	Nasal cannula over ear with 7 ft tubing	EA	\$1.37



**B**



**C**

### C. Size D & E Oxygen Cylinder

The size D aluminum oxygen cylinder is 400 liters and is fully labeled with a green shoulder. The size E cylinder is 682 liters. FDA compliant.

SKU	Description	UOM	Price
40711502	Oxygen cylinder size D 400 litre	EA	\$87.54
4071-1602	Oxygen Cylinder Size E 682 Litre	EA	\$98.17

### D. Oxygen Cylinder Wrench

This compact, plastic cylinder wrench is designed for D & E cylinders.

SKU	Description	UOM	Price
4071167WR	Oxygen E cylinder wrench nylon	EA	\$1.20



**D**



**A**



### A. Emergency Oxygen Resuscitator

This complete emergency oxygen resuscitation kit contains. One 1502D aluminum cylinder (416 liters), 1441 fixed flow regulator (6 LPM avg.), 1432 manual resuscitator, 1500A carry case, mask and tube.

SKU	Description	UOM	Price
4071-1528B	Emergency oxygen unit, resuscitator, mask and tube	EA	\$341.84

**B**



### B. LIF-O-GEN® Oxygen

This disposable emergency oxygen cylinder provides 15 minutes of oxygen U.S.P. for critical emergencies where use of oxygen is required until medical personnel can be summoned. At 3 lbs., it is lightweight and includes disposable cylinder, oxygen mask with 7 feet of oxygen tubing, and a 6 LPM regulator with contents (pressure) gauge.

SKU	Description	UOM	Price
3101500	LIF-O-GEN oxygen portable emergency unit	EA	\$255.44
31010510	LIF-O-GEN replacement cylinder	EA	\$136.32

### C. Crash Cart Oxygen Resuscitator

This crash cart kit is an oxygen unit on a cart with resuscitator. The kit contains: one 1603E aluminum cylinder, 1442 fixed flow mini-regulator (6 LPM avg.), 1432 manual resuscitator, mask and tube on a 370C chrome-plated cylinder cart.

SKU	Description	UOM	Price
4071-1629	Crash cart oxygen resuscitator unit	EA	\$410.57

**C**



**D**

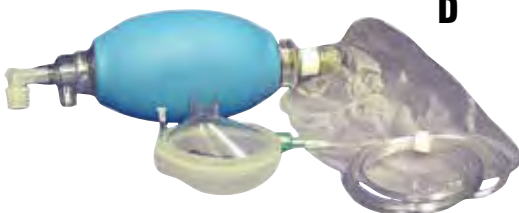

### D. Disposable Manual Resuscitator

The disposable adult manual resuscitator with oxygen bag reservoir is designed for single patient use, thus eliminating the danger of cross contamination. It is a safer alternative in today's environment, and has an anti-locking, one-way valve that prevents lock-up under high-flow conditions.

SKU	Description	UOM	Price
40712200	Disposable manual adult resuscitator w/oxygen bag	EA	\$21.18
AMB430013000	Disposable manual child resuscitator w/oxygen bag 16/cs	CS	\$325.18



**A**

### A. Perfit® Extrication Collar

The Perfit Extrication Collar is a rigid, one-piece construction with an extra large trachea opening and a flip chin piece. It folds flat for convenient storage and is latex free.

SKU	Description	UOM	Price
AMB000264003	Ambu Perfit extrication collar neckless	EA	\$9.93
AMB000264004	Ambu Perfit extrication collar short	EA	\$9.92
AMB000264005	Ambu Perfit extrication collar regular	EA	\$9.92
AMB000264006	Ambu Perfit extrication collar tall	EA	\$9.93
AMB000281000	Ambu Perfit Ace 4-IN-1 adjustable collar	EA	\$16.52

### B. Philadelphia Collar

Lightweight foam plastic molded and shaped to conform to any patient. Perforated holes for ventilation. Rigid plastic occipital and mandible post with double Velcro closure provide support. Shaped chin lines with moleskin.

SKU	Description	UOM	Price
57384573L	Philadelphia collar 3 1/4" large	EA	\$30.32
57384573M	Philadelphia collar 3 1/4" medium	EA	\$30.32



**B**

**C**



### C. Laerdal® Stifneck® Extrication Collar

The first one-piece rigid cervical collar developed specifically for pre-hospital care. When properly sized off the patient and then applied, the collars maintain the cervical spine in a safe, neutral position. Features a simple sizing method and distinct, color-coded straps and labels for easy identification and selection. Collars store flat for space conservation.

SKU	Description	UOM	Price
LAE980100	Stifneck baby no-neck extrication collar	EA	\$9.27
LAE980300	Stifneck collar - no-neck	EA	\$9.27
LAE980400	Stifneck collar - short	EA	\$9.27
LAE980500	Stifneck collar - regular	EA	\$9.27
LAE980600	Stifneck collar - tall	EA	\$13.48

### D. Laerdal® Stifneck® Extrication Collar Case

This convenient carrying case holds up to ten Stifneck® collars or other supplies for easy access. Supplies sold separately.

SKU	Description	UOM	Price
LAE980700	Stifneck carrying case	EA	\$42.67



**D**

### A. Headbed™ Head Immobilizer II

Space is always at a premium in an ambulance, so every inch of storage space must count. The HeadBed II CID provides maximum immobilization, yet is so compact that ten HeadBed II devices can be stored in the same space it takes to store only one block-type device. It provides outstanding patient access for effective assessment without compromising immobilization and comes with the patented Dual Adhesive Strap. Designed for single-patient use, so no cleanup or equipment recovery. Fits adults, children, and infants, as well as most spine boards.

SKU	Description	UOM	Price
LAE982000	Headbed Head Immobilizer II for adult & child	EA	\$8.05

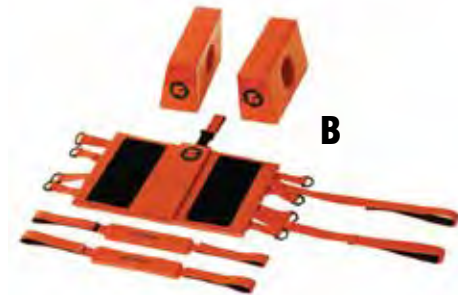
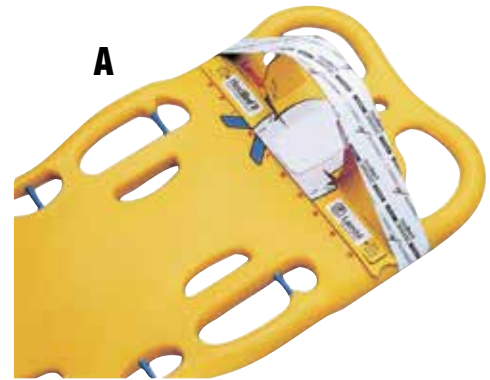

### B. Ferno Universal™ HeadImmobilizer

The easy to use, lightweight Universal Head Immobilizer features a universal attachment base, two closed-cell foam head supports and two head straps. Fits all Ferno backboards.

SKU	Description	UOM	Price
FERN0445	Universal head immobilizer	EA	\$156.58

### C. Ferno Millennia™ Plastic Backboard

This backboard is lightweight and has a contoured shape, which allows maximum maneuverability. Its easy-slide feature makes for efficient and smooth movement of patients up to 450 lbs. X-ray safe.

SKU	Description	UOM	Price
FERN02001BL	Backboard, blue plastic, 16"	EA	\$357.89
FERN02001OR	Backboard, orange plastic, 18"	EA	\$406.18



### D. Ferno Short Aluminum Backboard

Great for EMTs, this narrow, short, aluminum backboard is easy to maneuver into confined area. Various strapping methods can be used due to it's multiple strap openings.

SKU	Description	UOM	Price
FERN061	Backboard, short aluminum w/pad & restraints	EA	\$622.81

### E. Ferno Short Wooden Backboard

This wooden backboard features a notch head-end section that allows head straps to be placed according to patient size. The board is seven-ply, 1/2" marine-grade plywood and comes with three nylon body restraints, two head straps and a Adjusta-Pad neck roll.

SKU	Description	UOM	Price
FERN077	Backboard, wooden w/pad & restraints	EA	\$498.25







**A**

### A. Nylon Stretcher Bridle

The Stretcher Bridle Sling provides horizontal or vertical lifting with a capacity of up to 2,000 lbs. It is made of 1" nylon webbing that is resistant to moisture and fungus rot with forged snap hooks and a 3" ID forged steel suspension ring.

SKU	Description	UOM	Price
JUNJSA300-X	Nylon stretcher bridle sling	EA	\$171.53

### B. Wire Stretcher

This lightweight basket type stretcher has nylon web straps at chest, abdomen, thigh and calf. It features adjustable footrests for vertical lifting. The frame is made of 5/8" steel tubing and the cross braces and runners are 3/16" x 3/4" flat steel. The basket is 18 gauge, 1" hexagon mesh netting.

SKU	Description	UOM	Price
JUNSAF-300	Wire stretcher w/leg divider	EA	\$406.83
JUNSAF-300-W	Wire stretcher w/o leg divider	EA	\$406.83
JUNJSA-300XC	Bridle swing	EA	\$248.07

**B**



**C**



### C. Ferno Scoop EXL Stretcher

The lightweight, polyethylene scoop stretcher has Twin Safety Lock™ for smooth locking and unlocking. A narrow foot-end makes this stretcher ideal for use in confined spaces and angled handles make for easy transport.

SKU	Description	UOM	Price
FERN065	Scoop stretcher 66"-99" without case	EA	\$1071.05

### D. Ferno Model 71 Basket Stretcher

This high-density polyethylene basket stretcher is attached to an aluminum frame for maximum durability. Runners and hand holds are molded-in making it easy to handle. Resistant to chemical, UV, rust and corrosion. Restraints are included.

SKU	Description	UOM	Price
FERN071	Polyethylene basket stretcher, orange	EA	\$1097.74

**D**



### Adjustable Lifting Bridle

The adjusting lifting bridle features locking steel carabiners, which are welded in to prevent bridle separation, to attach at the lifting points. Each end is adjustable to the patient position.

SKU	Description	UOM	Price
FERN0418-1	Adjustable lifting bridle	EA	\$372.37

### A. Backboard Body Restraint

The backboard body restraint is made of 2" polypropylene webbing and has a side-release, snap-lock, plastic buckle. The strap features a hammed tab that prevents it from being pulled from the buckle. Available as a single strap or in a set of three.

SKU	Description	UOM	Price
FERN0430-1	Backboard body restraint 1 piece 2" nylon 7'	EA	\$48.69
FERN0439	Backboard restraint strap kit 3-7 ft straps	EA	\$115.79



### B. 2-Piece Body Restraint

These 5"x2" patient restraints feature a quick release buckles that are chrome plated to resist rust and corrosion. The straps are a nylon-polyester blend.

SKU	Description	UOM	Price
FERN07735SC	2-Piece body restraint w/speed clip 3/PK	PK	\$235.10

### C. FernoTrac™

The FernoTrac Traction Splint is great for patients with suspected lower extremities, long bone fractures. The tubular aluminum frame is easy to adjust and wide elastic straps keep the leg firmly in place. The heel stand folds down for easy storage.

SKU	Description	UOM	Price
FERN0443	FernoTrac 443 Traction Splint, pediatrics	EA	\$481.58
FERN0444	FernoTrac Adult Leg Splint	EA	\$501.42



### D. Ferno K.E.D. (Kendrick Extrication Device)

The Ferno K.E.D. (Kendrick Extrication Device) is a versatile, improved means of immobilizing and extricating patients from automobile accidents or confined spaces. The color-coded straps make application simple even in the dark or in extremely cramped areas. This device immobilizes the patients torso, head and neck, this allows prompt extrication while minimizing the risk of further injury. Three handles are integrated into the device to assist in better control of the patient during extrication.

SKU	Description	UOM	Price
FERN0125	Kendrick Extrication Device (K.E.D)	EA	\$151.35

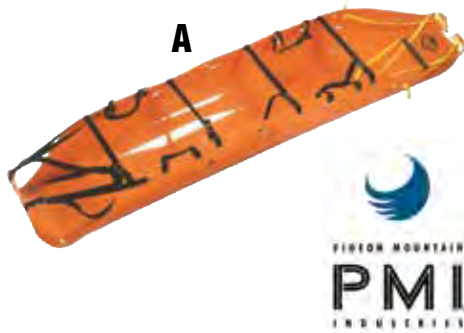

### A. Sked Stretcher System

Compact, lightweight and carries easily in its own case, Sked's unique shape and narrow profile accommodates patient evacuation through small openings such as manholes, sewers, ship hatches or caves. Components and optional equipment: Sked Stretcher (14 lbs), backpack (28 oz), horizontal lift slings (19 oz), tow strap (7 oz), webbing handle set/ 4 handles (3 oz). Note: Total Sked system consists of the above items plus 9.2m length of PMI 10mm E-Z bend and one large locking carabiner.

SKU	Description	UOM	Price
PMISK200	Sked stretcher system	EA	\$801.72

### B. Plastic Stretcher

The Junkin Plastic Stretcher has a yellow high-density polyethylene shell, supported by a stainless-steel outer rail that is permanently attached with stainless-steel semi-tubular rivets. It features molded runners, a fully exposed outer rail, a non-absorbent foam pad secured to stretcher and four patient restraint straps.

SKU	Description	UOM	Price
JUNSAF200	Plastic stretcher	EA	\$946.89



### C. Aluminum Stretcher

The Junkin Easy-Fold Stretcher is easily set up and is compact for storing. This Medical Corps type litter is lightweight, and has shaped hardwood handles on aluminum poles. The cover is durable 18 oz. vinyl coated nylon.

SKU	Description	UOM	Price
JUNSAF601NA	Stretcher aluminum pole 87" "easy fold"	EA	\$310.44

### D. Stretcher Pole Kit

The easy-fold stretcher kits consists of the Junkin "Easy-Fold" Stretcher with steel poles, the Junkin First Aid Blanket and a vinyl sheet; all housed in 20 gauge steel stretcher case. The kit may be wall mounted or has a handle for easy hand carrying.

SKU	Description	UOM	Price
JUNSAF655NA4	Stretcher pole kit w/restraints	EA	\$713.01

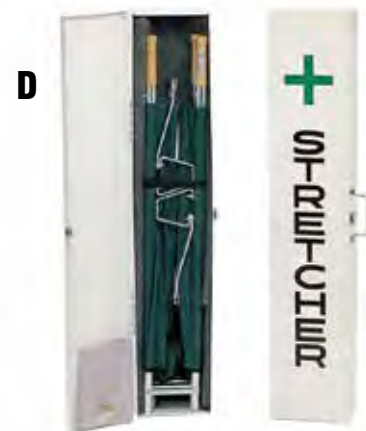

### E. Folding Cot

This all-purpose cot is for first aid and sick rooms, and ideal for heavy-duty use in industry or institutions. It is constructed of high strength anodized aluminum tubing to meet military standards, and is foldable for convenient storing. The cover is a strong 500 denier DuPont Cordura. Both head and foot ends elevate 15°, 30° and 45° degrees when required.

SKU	Description	UOM	Price
JUNSAF364	Folding cot w/elevated head and foot	EA	\$332.66
JUNSAF364P	Cot pad for folding cot, 1" thick	EA	\$67.21



### A. SAM® Splint

The SAM (Structural Aluminum Malleable) Splint contains all the properties of the many other splints which it replaces. Constructed of a strip of soft aluminum with a polyvinyl coating. The aluminum alloy presents no impediment to X-rays. When folded into a structural bend longitudinally, the splint becomes quite rigid and easily supports injured extremities. Can even be contoured and crimped to stabilize the cervical spine. Coating does not stain and is reusable with proper cleaning.

SKU	Description	UOM	Price
SAM1121	Sam splint roll, orange/blue	EA	\$16.88
SAM1208	Sam finger splint 10/BX	BX	\$17.60



### B



### B. Air Splint

Zippered air splints are constructed of a heavy-duty double polished soft vinyl which provides durability and easy cleaning. The clean vinyl construction allows observation and X-ray of injury. Special nylon zipper is X-ray transparent. All splints zip completely open for easy application. Special twist-turn valve with extension tube allows quick and easy inflation and adjustment. Specially formulated vinyl also resists cold cracking to -20°F.

SKU	Description	UOM	Price
MAR48-0002	Half arm air splint with zipper & screwlock valve	EA	\$19.43
MAR48-0006	Half leg air splint with zipper & screwlock valve	EA	\$25.52
MAR48-0001	Full arm air splint with Zipper & screwlock valve	EA	\$24.47
MAR48-0005	Full leg air splint with zipper & screwlock valve	EA	\$27.45

### C. Air Splint Kit

Zippered air splints are constructed of a heavy-duty double polished soft vinyl which provides durability and easy cleaning. The clean vinyl construction allows observation and X-ray of injury. Special nylon zipper is X-ray transparent. All splints zip completely open for easy application. Special twist-turn valve with extension tube allows quick and easy inflation and adjustment. Specially formulated vinyl also resists cold cracking to -20°F. Comes 6 to a package in a nylon case.

SKU	Description	UOM	Price
PRO660026	Air splint kit 6/CS with nylon case	CS	\$151.55



### D



### D. Padded Splint Boards

Padded board splints are made of 1/2" x 3" solid wood core with patient safe rounded corners. Orange reusable vinyl covered with 1/2" foam on one side.

SKU	Description	UOM	Price
MAR42-0100	Splint padded board left leg 3.5" x 54"	EA	\$15.27
MAR42-0114	Splint padded board right leg 3.5" x 36"	EA	\$10.80
MAR42-0118	Splint padded board for arm 3.5" x 15"	EA	\$7.23
MAR42-0200	Splint padded board asst 6s	BX	\$94.48

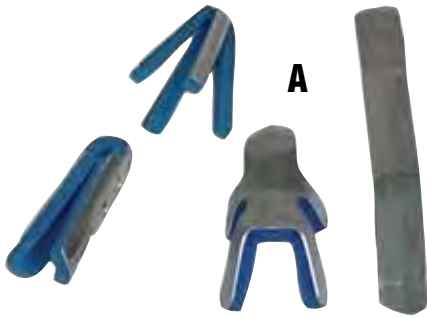

### A. Finger Splints

Protects injured finger or toe. Immobilizes entire digit

SKU	Description	UOM	Price
57380725S	Splint finger fold over small 12/BX	BX	\$28.55
57380725M	Splint finger fold over medium 12/BX	BX	\$28.55
57380725L	Splint finger fold over large 12/BX	BX	\$28.55
57380735M	Splint 4 prong with foam 12/BX medium	BX	\$30.12
57380735L	Splint 4 prong with foam 12/BX large	BX	\$30.12
57380740M	Splint toad finger medium 12/BX	BX	\$39.85
57380740L	Splint toad finger large 12/BX	BX	\$39.85
57380755S	Splint finger baseball small 12/BX	BX	\$48.78
57380755M	Splint finger baseball med 12/BX	BX	\$48.78
57380755L	Splint finger baseball large 12/BX	BX	\$48.78

### B. Plastic Finger Splint

The Prokot Plastic Finger Guard prevents further injury of fingers and toes when in place. They can be cut with scissors for a proper fit.

SKU	Description	UOM	Price
PAL122MED	Splint finger plastic medium 12/BX	BX	\$5.24
PAL123	Splint finger plastic large 12/BX	BX	\$5.24
PAL403	Splint finger assorted 12/BX	BX	\$5.24

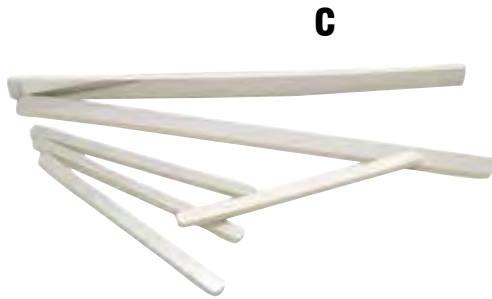
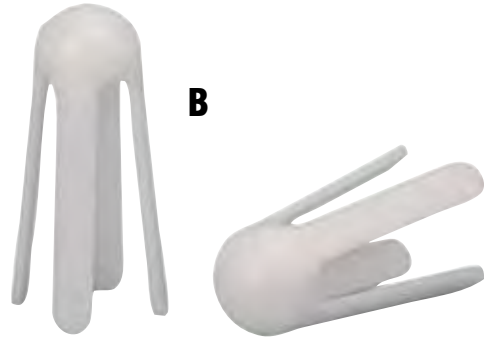

### C. AlumaFoam® Finger Splint

AlumaFoam splints are lightweight, sturdy, foam-laminated aluminum splints that contour for appropriate immobilization. The foam cushions and protects during recovery and as swelling subsides. Allowing X-rays to penetrate, the splints can be trimmed or formed to the therapeutically correct size. The AlumaFoam Finger Splint is ideal for immobilizing fractures, strains, sprains, cuts, tip and nail bed injuries.

SKU	Description	UOM	Price
15876112	Splints finger alumafoam 1/2" x 9" 24/BX	BX	\$15.37
15876212	Splints finger alumafoam 1/2" x 18" 12/BX	BX	\$23.89
15876134	Splints finger alumafoam 3/4" x 9" 12/BX	BX	\$20.33
15876234	Splints finger alumafoam 3/4" x 18" 12/BX	BX	\$18.44
15876210	Splints finger alumafoam 1" x 18" 12/BX	BX	\$20.00
15876215	Splints finger alumafoam 1.5" x 18" 6/BX	BX	\$15.14

### D. Finger Splint Roll

The roll of stat finger splint is pre-shaped, white polyvinyl plastic. The splint is easy to cut and comes in a 10 foot roll.

SKU	Description	UOM	Price
286762-1946	Stat finger splint roll 10 ft	EA	\$12.35



### A. Knowles Bandage Scissors

The Miltex Knowles scissors are straight and have a blunt end for cutting bandages.

SKU	Description	UOM	Price
4484V95-560	Scissors bandage KNOWLES 5 1/2 straight, Vantage	EA	\$9.27

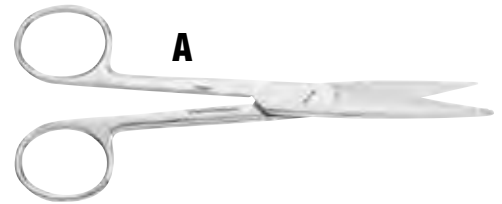

### B. Lister Bandage Scissors

The Lister scissors have an angled blade and a blunt end for cutting bandages.

Miltex:			
SKU	Description	UOM	Price
4484V95502SS	Lister bandage scissors 4 1/2", Vantage	EA	\$7.03
4484V95504SS	Lister bandage scissors 5 1/2", Vantage	EA	\$8.07
4484V95506SS	Lister bandage scissors 7 1/2", Vantage	EA	\$13.73
Medique:			
SKU	Description	UOM	Price
MF711-01	Bandage Lister scissors 5 1/2"	EA	\$1.52
Trans-American:			
SKU	Description	UOM	Price
MSS1050	Bandage Lister scissors 5 1/2"	EA	\$2.50

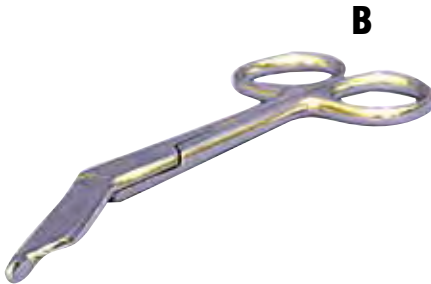

### C. EMT Scissors

EMT scissors feature a serrated blade that make them great for cutting through multi-layered clothing or bandages.

Miltex:			
SKU	Description	UOM	Price
44845-998	EMT scissors utility with plastic handle 6"	EA	\$17.85
44845-1000	EMT scissors utility with Plastic Handle 7 1/2 "	EA	\$17.70
Medique:			
SKU	Description	UOM	Price
MF709-01	EMT utility scissors 7"	EA	\$3.71



### D. Utility Shears

Utility scissors. Stainless-steel.

SKU	Description	UOM	Price
MSS1082	Scissors utility shears 6"	EA	\$2.50
MSS1080	Scissors utility shears 7 1/2"	EA	\$3.75

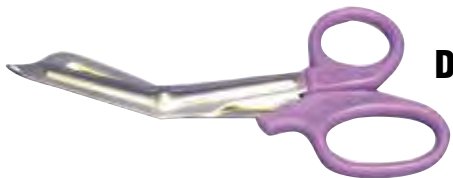

### SPENCER Stitch Scissors

The Miltex Spencer stitch scissors feature a notched tip that allows for easy suture selection.

SKU	Description	UOM	Price
4484V99-100	Spencer stitch scissors 3 1/2", Vantage	EA	\$11.96

### E. Kit Scissors

The first aid kit scissors are perfect for cutting bandages and clothing.

SKU	Description	UOM	Price
MF706-01	Kit scissors	EA	\$ .36





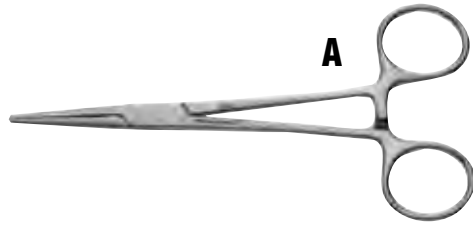

### A. Kelly Forceps

For a quick and easy clamp during procedures, choose the 5 1/2" straight KELLY forceps.

Miltex:			
SKU	Description	UOM	Price
4484V97-36	Kelly forcep 5 1/2" straight, Vantage	EA	\$10.79
Trans-American:			
SKU	Description	UOM	Price
MSS1740	Kelly forcep 5 1/2" straight	EA	\$3.33

### B. Vantage Operating Scissors - Curved

Vantage Operating Scissors, 4-1/2" (11.4 cm), curved

SKU	Description	UOM	Price
4484V95-42	Vantage Operating Scissors - Curved sharp/blunt	EA	\$6.42
4484V95-32	Vantage Operating Scissors - Curved sharp/sharp	EA	\$6.42

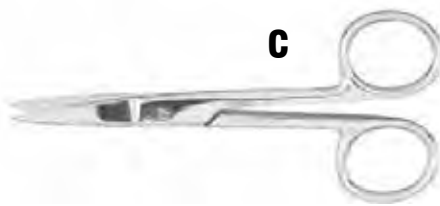
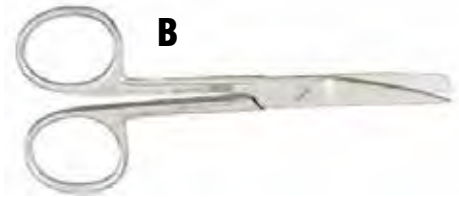

### C. Vantage Operating Scissors - Straight

VANTAGE Operating Scissors, 4-1/2" (11.4 cm), straight

SKU	Description	UOM	Price
4484V95-12	Vantage Operating Scissors - Curved sharp/blunt	EA	\$5.95
4484V95-2	Vantage Operating Scissors - Curved sharp/sharp	EA	\$5.95

### D. Kit Tweezers

Kit tweezers are essential to any first aid kit. They aid in the removal of foreign objects from the skin.

SKU	Description	UOM	Price
MF720-01	Kit tweezers, stainless-steel	EA	\$.36

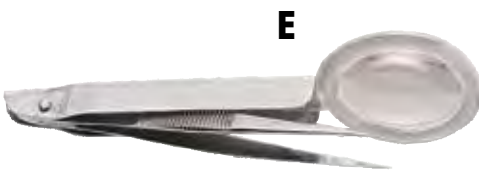

### E. Forceps with Magnifier

These 3" splinter forceps come with a magnifier, making them ideal for the removal of very small objects.

Miltex:			
SKU	Description	UOM	Price
4484V96-329	Forceps with magnifier, Vantage	EA	\$16.69
Medique:			
SKU	Description	UOM	Price
MF721-01	Splinter tweezers w/magnifier	EA	\$3.26

### F. Splinter Probe

The stainless-steel splinter probe is a convenient way to search a small area for an allusive splinter.

SKU	Description	UOM	Price
MF716-01	Stainless-steel splinter probe	EA	\$2.47



### A. Splinter Forceps

These stainless-steel splinter forceps feature sharpened ends that help find even the smallest items.

Miltex:			
SKU	Description	UOM	Price
4484V96-300	Splinter forceps 3 1/2" fine points, Vantage	EA	\$5.41
4484V96-304	Splinter forceps 4 1/2" fine points, Vantage	EA	\$6.02
Trans-American:			
SKU	Description	UOM	Price
MSS2410	Splinter forceps 4 1/2" fine point	EA	\$1.50



### B



### B. Splinter Out™

Splinter Out features individually wrapped sterile splinter removers with tri-bevel points that help loosen the splinter and then pull it out of the skin.

SKU	Description	UOM	Price
MF765-12	Splinter Out in plastic case, 1 X 10s	BX	\$1.90
MDPT19908	Splinter Out 1 X 20s	BX	\$2.08

### C. Splinter Removal Kit

The Miltex Liberator is used to approach an embedded fragment by elevating the epidermis. After the fragment is exposed, the Walter forceps are used for quick and easy splinter removal.

SKU	Description	UOM	Price
4484V96-410	Splinter removal kit with forcep & liberator	EA	\$27.13
4484V96-400	Splinter liberator with reversible handle	EA	\$9.97



### D



### D. Curity® Suture Removal Kit

This suture removal kit comes with Littauer scissors, metal forceps and a 3 x 3 gauze sponge. It comes in a single sterile package

SKU	Description	UOM	Price
614166200	Suture removal kit with Littauer scissors/metal forceps	EA	\$1.28

### E. Ring Cutter

Ring cutters are an essential part of any first aid kit because they provide a quick, easy way to remove rings from swollen or injured fingers.

SKU	Description	UOM	Price
MSS3235	Ring cutter finger	EA	\$16.67
MSS3235B	Ring cutter blade only for MSS3235	EA	\$4.17

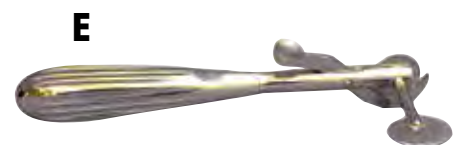



### A. Drill Points

The standard pattern fingernail drill is chrome plated and comes with three drill points, small, medium and large. All points can be stored in the handle, which measures 4".

SKU	Description	UOM	Price
448433-230	Drill points chrome standard fingernail	EA	\$96.98
448433-234	Replacement drill points set of 3 fingernail	BX	\$42.72

### B. Eye Magnet

The eye magnet and loop is designed to aid in the removal of metallic and non-metallic foreign objects from the eye. The magnet attracts metal objects, making their removal easier.

SKU	Description	UOM	Price
448418-398	Eye magnet and foreign body loop	EA	\$74.45
MF717-01	Eye magnet & loop w/case	EA	\$6.80

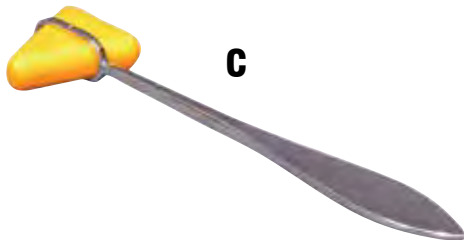

### C. Percussion Hammer

Test patient's reaction time with this neurological hammer.

SKU	Description	UOM	Price
44841-220	Buck neurological hammer chrome plated	EA	\$15.94
44841-202	Taylor percussion hammer large chrome	EA	\$4.57

### D. Pinwheel

The Wartenberg pinwheel is great for evaluating the gross cutaneous sensory and pain perception and responses.

SKU	Description	UOM	Price
4484V91-226	Pinwheel Wartenberg, Vantage	EA	\$34.01





### A. Disposable Sterile Scalpels

Miltex® Scalpels are pre-assembled and sterile. Stainless steel surgical blades mounted on plastic handles with fluted finger grips. The scalpel blade is safely protected by an easy pull-off protector. Each sterile scalpel is sealed in a peel-apart, see-through package. Ten scalpels are packaged in a handy dispenser box for convenient use. Ready to use.

SKU	Description	UOM	Price
44844-410	Disposable sterile scalpels #10 10/BX	BX	\$12.75
44844-411	Disposable sterile scalpels #11 10/BX	BX	\$12.75
44844-415	Disposable sterile scalpels #15 10/BX	BX	\$12.75



### B. Instrument Trays

Heavy duty seamless trays by Polar Ware have curved corners for easy sterilization. Stainless-steel.

SKU	Description	UOM	Price
51441202-0	Tray, instrument 12-1/4" x 7-3/4" x 2-1/4"	EA	\$39.68
51441202-2	Tray, instrument cover for 1202 12-1/4" x 7-3/4"	EA	\$29.28
5144952-2	Tray, instrument cover lid 8-7/8" x 5"	EA	\$26.67
5144952-0	Tray, instrument stainless-steel 8-7/8" x 5" x 2"	EA	\$21.95

### C. Surgical Cauterise

High temperature cautery. This fine tip cautery is used to pinpoint hemostasis and for evacuation of a subungual hematoma.

SKU	Description	UOM	Price
0020AA01	Surgical cauteries high temperature with fine tip	EA	\$11.12

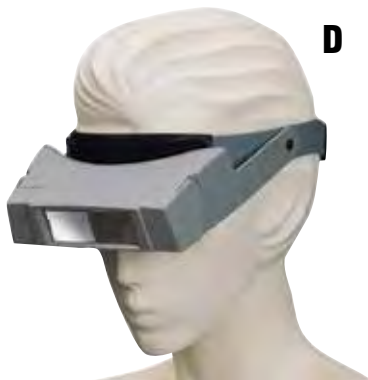

### D. Standard Magnifying Binocular Loupe

This standard magnifying binocular loupe features a single lens, with no center post, which increases the viewing area for clear, comfortable unobstructed vision. Magnification makes the smallest details large and sharp and the inter-changeable lens plate units snap on and off instantly without screws or tools. The loupe has a convenient flip-up, flip-down feature for regular vision and magnification.

SKU	Description	UOM	Price
2867401203	Standard magnifying binocular loupe ST 4" +10D	EA	\$47.38

### E. OptiVISOR®

The OptiVISOR® is a precision glass binocular magnifier. Interchangeable lens powers ground and polished to precision ophthalmic standards. The advanced prismatic lens system assists in focusing, reducing eyestrain and can be worn over prescription or safety eyeglasses. Providing 3D magnification while leaving both hands free to allow maximum efficiency, the OptiVISOR® is the Choice of Professionals.

SKU	Description	UOM	Price
DONDA-4	OptiVISORS binocular mag 4 diopter	EA	\$53.23
DONDA-7	OptiVISORS binocular mag 7 diopter	EA	\$55.05





**A**

### A. Disposable Penlights

These durable, disposable penlights keep lumination close at hand. No battery changes are required; use them until they die and throw them out. The long-life of these lights make them an ideal economical buy. Reusable version also available.

SKU	Description	UOM	Price
00206303	Cobalt blue difusse disp. 3/PK	PK	\$10.52
00206666	Disposable hi-intensity penlights 6/pk	PK	\$9.79

### B. Reusable Penlights

Diagnostic penlights provide a high intensity stream of light for use during exams, and are reusable.

SKU	Description	UOM	Price
MAB32765000	Pen light diagnostic reusable	EA	\$3.28



**B**



**C**

### C. Fluoro Light

Fluoro-Dot Cobalt Blue Penlights were designed for use with fluorescent dye and are excellent for diagnosing abrasions and fitting contact lenses. Uses two-AA batteries. Two year shelf life.

SKU	Description	UOM	Price
0020-6802	Light Fluoro-Dot blue spot	EA	\$32.06
0020-6803	Light Fluoro-Slit blue slit	EA	\$35.27

### D. Ful-Glo®- Fluorescein Sodium Strips, USP

For staining the anterior segment of the eye when fitting contact lenses, in disclosing corneal injury or in applanation tonometry. Each sterile strip is impregnated with 1.0mg of fluorescein sodium USP.

SKU	Description	UOM	Price
7478-0400-01	Ful-Glo® fluorescein sodium ophthalmic strips 100/BX	BX	\$22.92



**D**

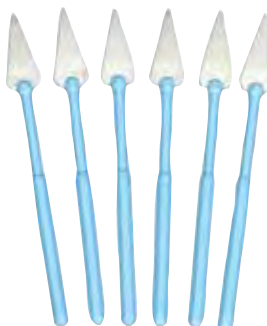

**E**

### E. Eye Spears

Designed for microscopic sponging in the ocular area. Practically non-linting and extremely absorbent, the fine pore cellulose fiber is compressed and cut into spear shapes and attached to a small plastic handle.

SKU	Description	UOM	Price
603330-049	Surgical eye spears - sterile 10/PK-10PK/CS	CS	\$45.93

### A. Plastic Eye Chart

The Snellen type plastic eye chart has a non-reflective, matte finish with green and red color bars. For use at a 20' distance, it measures 22" x 11".

SKU	Description	UOM	Price
286713-1240	Eye chart-plastic	EA	\$5.84

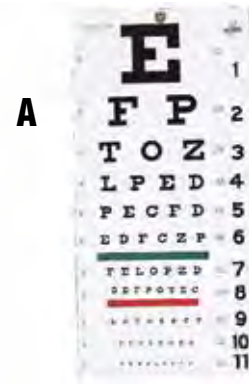

**B**

### B. Illiterate Eye Chart

The eye chart for the illiterate patient features green and red color bars and should be used at a 20' distance. It measures 22" x 11".

SKU	Description	UOM	Price
286713-1241	Eye chart-illiterate	EA	\$7.46

### C. Jaeger Reading Chart

The Jaeger reading and test-type plastic chart is printed on both sides and designed to be read from a distance measured in meters. It measures 4-3/4" x 7".

SKU	Description	UOM	Price
286713-1242	Eye chart-plastic Jaeger reading	EA	\$8.25

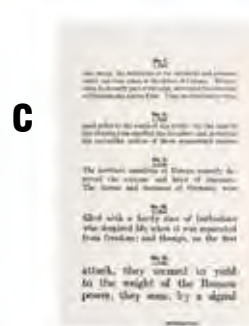

**C**



**D**

### D. Kindergarten Eye Chart

The kindergarten plastic eye chart shows easy to distinguish objects from a distance of 20'. It measures 22" x 11".

SKU	Description	UOM	Price
286713-1243	Eye chart-kindergarten test	EA	\$8.25

### E. Ishihara® Test Chart Books, for Color Deficiency

Leading authorities accept the Ishihara test chart books, for color deficiency as a simple and accurate method for discovering congenital color blindness and red-green blindness, each in two forms, complete and incomplete. Includes four special plates for tests to determine the kind and degree of defect in color vision. Makes use of the peculiarity that in red-green blindness, blue and yellow appear remarkably bright compared with red and green. Color plates are encased in specially designed album-type books for ease of handling and detailed instructions are included with this 14-plate book.

SKU	Description	UOM	Price
286713-1254	Eye chart book 14 plate test	EA	\$202.75

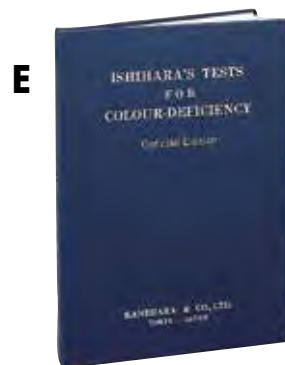

**E**





**A**

### A. Aneroid Economy Sphygmomanometer

This economical sphygmomanometer features a standard bulb, standard air release valve and calibrated blue nylon cuff with hook and loop closure.

SKU	Description	UOM	Price
MAB01149011	Sphygmomanometer aneroid economy adult	EA	\$18.86
MAB01149016	Sphygmomanometer aneroid economy large adult	EA	\$29.39

### B. Wall Baumanometer

Every Baumanometer® instrument is a true gravity manometer. It is set apart from others as the world standard for blood pressure measurement by a simple principle: devotion to uncompromising quality. Simple in design, the Baumanometer® Wall Unit 33 is convenient to use, functions on the immutable law of gravity and is guaranteed to remain scientifically accurate. A 300mmHg swivel-type instrument for wall mounting which includes a Calibrated® V-Lok® cuff. Basket included.

SKU	Description	UOM	Price
06610850	Baumanometer® wall mount sphygmomanometer with basket	EA	\$195.00

**B**



**C**

### C. Welch Allyn Tycos® Classic Hand Aneroid Sphygmomanometer

The Classic offers unsurpassed reliability in a traditional hand held design. This gauge has a durable cast iron housing and large inflation bulb. All Classic gauges have certified accuracy to +/- 3 mmHg. Each gauge has its dial face individually laser engraved based on movement for optimum accuracy. The Classic has a jeweled movement for smooth, long lasting and reliable operation. Latex free.

SKU	Description	UOM	Price
54675098-02	Hand aneroid sphygmomanometer, Velcro cuff	EA	\$253.68

### D. Welch Allyn DS45 Integrated Aneroid Sphygmomanometer

The DS45 features Welch Allyn's DuraShock® shock resistant technology making this gauge not only very accurate but extremely rugged. Integrated design allows the gauge to be snapped into the cuff. Gauge will rotate 360 degrees for easy viewing. Comes complete with a durable inflation system. This is a great value! Latex Free.

SKU	Description	UOM	Price
54677050-14	Tycos aneroid sphygmomanometer w/adult cuff	EA	\$133.86
54677050-24	Tycos aneroid sphygmomanometer w/large adult cuff	EA	\$143.59
54675090-02	Tycos pocket sphygmomanometer w/adult cuff	EA	\$253.68

**D**



**A. Omron® Blood Pressure Monitor with Printer**

Keep accurate records of your blood pressure readings with the Blood Pressure Monitor and Print Out. Simply wrap the cuff around your arm and press START. In seconds, your blood pressure and pulse are displayed on the large digital panel. You can then print your readings in either numerical or bar graph form for easy record keeping.

SKU	Description	UOM	Price
4187HEM705CP	Blood Pressure Monitor with Printer	EA	\$146.53



**B. Omron® Intellisense® Portable Blood Pressure Monitor- Wrist**

Advanced, portable model is slim and more discrete for readings anywhere you go. It employs smart Heart Guide Technology, which is automatically activated the moment your wrist is at heart level, for a precise reading every time. Automatically activates when your wrist is at heart level, ensuring consistently accurate readings. Flashing orange and blue indicator lights help guide your wrist to your heart level, making it easier to find the correct position.

SKU	Description	UOM	Price
4187HEM650	Portable wrist blood pressure monitor	EA	\$113.61

**C. Omron® Intellisense® Automatic Blood Pressure Monitor**

The Omron Automatic Blood Pressure Monitor with Intellisense features one touch inflation, a large digital display, and 30 reading memory with date/time stamp. Automatic averaging of last 3 readings. Fits 9" to 13" arm circumference. Large cuff available for arm sizes 13" to 17". Powered by AC adapter or 4 AA batteries, both sold separately.

SKU	Description	UOM	Price
4187HEM712C	Blood pressure monitor adult	EA	\$83.37
4187HEMADPT1	AC adapter for Ormon monitors	EA	\$30.57



**D. Touch Key Ultra Digital Blood Pressure Arm Monitor**

Ultra Digital Blood Pressure Monitor features sensitive touchscreen buttons that require little pressure and light up for easier identification. Features include: Displays systolic, diastolic and pulse readings simultaneously. WHO Indicator provides an instant comparison to standards set by the World Health Organization. Irregular Heartbeat Detection lets the user know if an abnormal reading has occurred and soft, comfortable cuffs.

SKU	Description	UOM	Price
MAB04596008	Blood pressure monitor w/memory 2 cuff	EA	\$107.03

## Diagnostic Testing



### A. 3M™ Littmann® Cardiology III Stethoscope

Outstanding acoustics and superior versatility are combined in the technology of the 3M Littmann Cardiology III Stethoscope. Featured is both an adult and pediatric-sided chestpiece, each incorporated with a tunable diaphragm. This innovative design allows you to use both sides of the stethoscope, for monitoring high and low-frequency sounds. Also features solid stainless-steel chestpiece, two-tubes-in-one design, non-chill rims, comfortably angled, anatomically correct headset and patented 3M Littmann Snap-tight Soft-sealing Eartips.

SKU	Description	UOM	Price
43182128L	Littmann Stethoscope Cardiology III 28" black	EA	\$227.08

### B. 3M™ Littmann® Classic II S.E. Stethoscope

The Littmann Classic II S.E. stethoscope offers a traditional bell combined with a tunable diaphragm that conveniently alternates between low and high frequency sounds without the need to turn over the chestpiece. Featuring a two-sided chestpiece, this classic stethoscope offers high acoustic sensitivity for superior performance.

SKU	Description	UOM	Price
43182205	Littmann Stethoscope Classic II 28" blue	EA	\$114.95

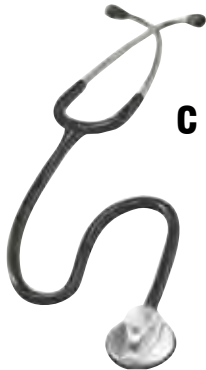
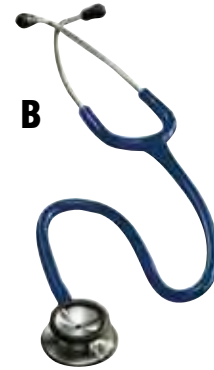

### C. 3M™ Littmann® Master Classic II Stethoscope

The 3M Littmann Master Classic II Stethoscope features a computer-designed chest piece allows alteration between low and high-frequency sounds without moving the chest piece. To hear low-frequency sounds typically heard with a traditional bell side of a chest piece, use light contact pressure on the skin; to hear high-frequency sounds typically heard with a diaphragm side, apply firm contact pressure. High-frequency response allows one to hear faint lung sounds.

SKU	Description	UOM	Price
43182144L	Littmann Stethoscope Master Classic II 27" black	EA	\$189.32

### D. 3M™ Littmann® Lightweight II S. E. Stethoscope

The Lightweight II S.E. Stethoscope is a general-purpose, entry-level stethoscope and is an excellent, affordable choice for basic blood pressure and limited physical assessment. It has 28" tubing with a silver bell-type chestpiece.

SKU	Description	UOM	Price
43182197	Littmann Lightweight II S.E. Stethoscope blue	EA	\$74.95



### E. Dual Head Stethoscope

The Baum stainless steel dual head stethoscope is designed for general healthcare applications and offers outstanding acoustics.

SKU	Description	UOM	Price
06612720	Dual head stethoscope	EA	\$35.00



### A. Dual Teaching Stethoscope

The teaching stethoscope has excellent acoustical clarity. It features 22", latex-free tubing with a connector that allows both student and instructor to listen simultaneously. This stethoscope has an anodized aluminum combination dual head chestpiece, chrome-plated brass rotating stem and an adjustable chrome-plated external spring binaural.

SKU	Description	UOM	Price
286704-540	Dual teaching stethoscope	EA	\$16.95



### B. Sprague Rappaport Stethoscope

Features certified sound that is guaranteed to provide the acoustical performance to meet the increasing demands of the healthcare professional. Comes with three different size open bells, two different size replacement diaphragms and two pairs of ear tips in a vinyl storage case.

SKU	Description	Color	UOM	Price
105441622DB	Sprague Rappaport stethoscope	Blue	EA	\$14.12
105441622GRN	Sprague Rappaport stethoscope	Green	EA	\$14.12
105441622RED	Sprague Rappaport stethoscope	Red	EA	\$14.12

### C. Dual Head Stethoscope

The Ormon® Dual-head Stethoscope is lightweight and durable, and features a molded, one-piece tubing for excellent sound quality.

SKU	Description	Color	UOM	Price
1054412BLK	Lightweight stethoscope with dual head	Black	EA	\$7.11
1054412GRAY	Lightweight stethoscope with dual head	Gray	EA	\$7.11
1054412PINK	Lightweight stethoscope with dual head	Pink	EA	\$7.11
1054412RED	Lightweight stethoscope with dual head	Red	EA	\$7.11
1054412BURG	Lightweight stethoscope with dual head	Burgundy	EA	\$7.11
1054412DKGRN	Lightweight stethoscope with dual head	Green	EA	\$7.11
1054412GRN	Lightweight stethoscope with dual head	Hunter Green	EA	\$7.11



### D. Nurse's Stethoscope

The Spectrum Series of nurse stethoscopes offers the healthcare professional an economical solution for those situations that require a quality listening device. Each stethoscope features a chrome-plated brass binaural, lightweight anodized aluminum chestpiece and 22" vinyl Y-tubing.

SKU	Description	Color	UOM	Price
MAB10428240	Nurses's lightweight stethoscope	Navy Blue	EA	\$5.49



### A. Pneumatic Otoscope Set

Pneumatic Otoscope. 3.5v halogen light. Rotating lens with ultra-seal. Fiber optic illumination. Complete with five polypropylene specula.

SKU	Description	UOM	Price
678320000	Pneumatic otoscope	EA	\$312.37

### B. Operating Otoscope

Operating Otoscope. 3.5 volt halogen light. Open system. Rotatable lens and speculum. Fiber optic illumination. Includes five reusable specula; sizes 2, 3, 4, 5 and 9mm.

SKU	Description	UOM	Price
678321700	Operating otoscope w/specula 3.5V	EA	\$240.36



### C. Diagnostic Otoscope

Halogen lighting coupled with fiber optics provides brilliant and cool distal illumination without visual obstruction or specular reflections. Halogen 3.5v head complete with four polypropylene specula. Includes 4 specula, sizes 2.5, 3, 4 and 5mm.

SKU	Description	UOM	Price
678325020	Otoscope	EA	\$185.65

### D. MacroView Otoscope

The MacroView provides twice the field of view of traditional otoscopes. Features halogen lighting coupled with fiber optics provides brilliant and cool distal illumination without visual obstruction or specular reflections.

SKU	Description	UOM	Price
678323810MC	Otoscope MacroView 3.5V halogen with 4 specula head only	EA	\$273.46
678325070M	Otoscope set 3.5V MacroView with case	EA	\$498.19



### E. Diagnostic Set

This portable 3.5 volt, halogen, diagnostic set features Welch Allyn's finest ophthalmoscopes, otoscopes and nasal illuminators.

SKU	Description	UOM	Price
678397150	3.5 volt halogen diagnostic set	EA	\$810.74
678397210	Welch Allyn diagnostic set	EA	\$868.42

### A. Standard Ophthalmoscope - Six Apertures

This ophthalmoscope is a general as well as a specialist use instrument. 3.5 volt halogen light. 5 apertures. 28 lenses -25 to +40 diopters. Illuminated lens dial.

SKU	Description	UOM	Price
678311710	Ophthalmoscope 3.5V, halogen	EA	\$306.26



### B. Coaxial Ophthalmoscope - Six Apertures

Coaxial Ophthalmoscope. 3.5 volt halogen light with HPX lamp provides 30% more light output for true tissue color and consistent long-lasting illumination. The coaxial optical system allows for shadow free spots and easier entry into undilated pupils.

SKU	Description	UOM	Price
678311720	Coaxial ophthalmoscope 3.5V, halogen	EA	\$326.18

### C. Pocketscope Otoscope

Pocket Otoscope uses fiber optics halogen light for a long-lasting consistent inspectability. The scope has a wide angle viewing lens and built in throat illuminator. The set comes with batteries in the handle. Uses AA batteries.

SKU	Description	UOM	Price
678322820	Pocketscope otoscope with AA battery handle	EA	\$265.35



### D. Pocketscope Handle

Pocketscope replacement handle with AA batteries.

SKU	Description	UOM	Price
678372820	Pocketscope handle w/AA batteries	EA	\$101.23

### E. Rechargeable Handle

Rechargeable battery handles for all 3.5v instruments offer dependable power and mobility for any practitioner. Charged easily from any power outlet.

SKU	Description	UOM	Price
678371000	Rechargeable handle for otoscope/ophthalmoscope	EA	\$218.52





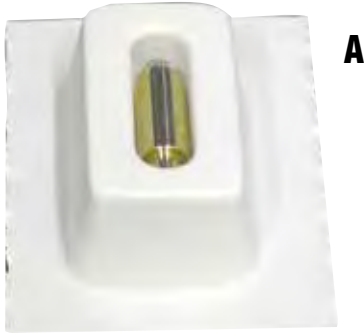

**A**

### A. Otoscope Replacement Bulb

Halogen replacement lamp for PocketScope Otoscope/Throat Illuminator.

SKU	Description	UOM	Price
678303400	Replacement bulb for coaxial ophthalmoscope (11720, 11730 & 11735)	EA	\$28.89
678303000	3.5 Volt halogen ophthalmoscope replacement lamp (11710)	EA	\$28.32
678303100	3.5 Volt otoscope replacement lamp	EA	\$26.32

### B. Kleenspec™ Disposable Specula

Specula are made of non-toxic plastic to be used once, then discarded. No adapter required.

SKU	Description	UOM	Price
678352134	Kleenspec disposable specula for pneumatic operating 4MM 500/BX	BX	\$42.91
678352135	Kleenspec disposable specula for pneumatic operating 5MM SP 500/BX	BX	\$43.38
678352133	Kleenspec disposable specula for pneumatic operating 3MM 500/BX	BX	\$42.91
678352432	Kleenspec specula 2.5MM for diagnostic 850/BX	BX	\$40.96
678352434	Kleenspec specula 4.25MM for diagnostic otoscope 850/BX	BX	\$40.96



**B**



**C**

### C. Replacement Batteries

Transformer-style batteries. Contain nickel cadmium.

SKU	Description	UOM	Price
678372200	Battery replacement - 3.5V rechargeable	EA	\$56.65
678372000	Battery replacement - 2.5V rechargeable	EA	\$50.63

### D. Nasal Illuminator

3.5v halogen light. Fiber optic illumination for cool light. Illuminator is convertible to throat illuminator/penlight.

SKU	Description	UOM	Price
678326550	Nasal illuminator for otoscope	EA	\$174.62

### Desk Charger with Two Handles

Complete unit includes charger No. 71110 and two 3.5v rechargeable handles No. 71670, 110-130v 50/60 Hz, UL listed and CSA certified. Compact charger base measures only 3-3/8" (86mm) x 7-1/4" (184mm).

SKU	Description	UOM	Price
678371610	Charger desk 3.5V & 2 handles 71670	EA	\$603.99

### Wall Charger with Two Handles

Diagnostic system includes 3.5v wall transformer and two handles.

SKU	Description	UOM	Price
678376710	Wall transformer 3.5V unit & 2 handles	EA	\$618.81

### Insufflator Bulb

Replacement insufflator bulb and tube with tip.

SKU	Description	UOM	Price
678321504	Insufflator bulb and Tube w/tip	EA	\$12.86



**D**

### A. Medi-First® Digital Thermometer

This thermometer provides a fast, accurate digital read out and comes with a case.

SKU	Description	UOM	Price
MF708-01	Digital thermometer w/case	EA	\$12.67



### B



### B. Mabis Digital Thermometer

This thermometer features a 60-second read-out in either Celsius or Fahrenheit.

SKU	Description	UOM	Price
MAB15-713-00	Digital thermometer w/case hospital	EA	\$4.86
MAB15-618-00	Digital thermometer probe cover 100/BX	BX	\$4.84

### C. Temporal Scanner Thermometer

The Temporal Scanner Thermometer is a totally non-invasive system with advanced infrared technology providing maximum ease of use with quick, consistently accurate measurements. Advanced, patented technology measures temperatures with a gentle stroke across the forehead.

SKU	Description	UOM	Price
EXE124275	TemporalScanner	EA	\$669.70



### D



### D. Braun ThermoScan® PRO 4000 Professional Thermometer

Braun® ThermoScan PRO 4000. The infrared thermometer for professional usage in hospitals and offices. Convenient measurements in the ear in just three seconds. High durability (battery life of 1,000 measurements). Preheated probe tip improves accuracy. Patient temperature range: 68.0 - 108°F. Ambient temperature range: 50.0 - 104 °F. Large, easy-to-read LCD displays temperatures in either Fahrenheit or Celsius.

SKU	Description	UOM	Price
6322-PRO4000	Braun ThermoScan professional thermometer	EA	\$280.53
6322-PC800	Braun ThermoScan probe covers 800/CS	CS	\$86.46



**A**

### A. NexTemp Disposable Thermometer

Throw away the germs! Individually wrapped NexTemp thermometers are designed to reduce the risk of cross infection or reinfection that could occur with other thermometer systems. Simply discard the thermometer after patient use.

SKU	Description	UOM	Price
NEX1112-20	Nextemp Disposable Thermometer 100/BX	BX	\$15.37

### B. Astra 300 Spirometer Kit

Easily report your choice of up to 40 spirometry test parameters, all measured accurately and precisely with the highly sophisticated Astra300 Spirometer. Using the bright and sensitive touchscreen, you can easily access multifunctional capabilities and view both graphic and tabular data. Entering patient data, patient testing and reporting couldn't be easier. Exporting test data to a printer or PC via USB is quickly accomplished with just a few stylus taps on the touchscreen.

SKU	Description	UOM	Price
SDI295301050	Astra 300 Spirometer Kit, Printer, OH Module, Syringe and Filters	EA	\$3209.39



**B**



**C**

### C. AstraGuard Bacterial/Viral Filter

The AstraGuard Bacterial/Viral Filter provides virtually perfect infection protection for expiratory and inspiratory spirometry testing. Its single-patient use greatly reduces costly and time-consuming disinfection procedures.

This easy-to-use disposable mouthpiece incorporates a highly efficient woven filter that virtually eliminates cross-contamination from patient to patient and from patient to health care professional.

SKU	Description	UOM	Price
SDI29799050	AstraGuard Bacterial/Viral Filter 50/BX	BX	\$103.28

### D. AstraPulse FT Oximeter

The AstraPulse FT oximeter features the latest technology for measuring oxygen saturation and heart rate. It uses state-of-the-art power-sparing Organic LED displays. The advanced fingertip tunnel design eliminates the problems encountered with measurements of patients with thin or wide fingers and a three year warranty attests to the durability and reliability of the FT series. When shopping for fingertip pulse oximeters, compare the SDI fingertip models with any others on the market. Feature-for-feature, AstraPulse oximeters stand out in a class all their own.

SKU	Description	UOM	Price
SDI29-6000	AstraPulse FT Oximeter	EA	\$182.70



**D**



**A. Digit-Ox™ Pulse Oximeter**

Delivers fast, reliable oximetry in an extremely handy, pocket size solution by combining the monitor and sensor into one unit. While it's small in size Digit is big on performance, providing fast, reliable SpO2, pulse rate and pulse strength measurements for patients from pediatric to adult. This affordable, non-invasive device offers the convenience clinicians appreciate in EMS, hospital or clinical environments as well as home use. Features: SpO2: Range: 0 to 99% functional SpO2 (1% increments), Accuracy: +/- 2% at 70 to 99% less than 70% unspecified, Averaging: 8 seconds average. Pulse Rate: Range: 30 to 254bpm (1 bpm increments), Accuracy: +/- 2% or 2 bpm (whichever is greater). Power requirements: 2 AAA cell Alkaline Batteries. Battery Life: 16 hours continuous use, 1,400 spot checks, 1 min. on, 2 min. off. Two Year Warranty



SKU	Description	UOM	Price
INVISG8600	Digit-Ox™ pulse oximeter	EA	\$417.21

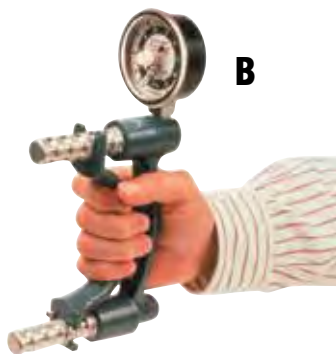

**B. Baseline® Hand Dynamometer**

The Baseline hand dynamometer gives accurate grip strength readings without the subject being able to “feel” the handle move. The results are consistent with published Baseline and Jamar® studies. The internationally accepted design assures reliability, user convenience and measurement repeatability. The five position adjustable handle can accommodate any hand size. The maximum reading remains until the unit is reset. The strength reading can be viewed as pounds or kilograms. Each dynamometer comes in a molded carrying case. The unit is made in the USA and has a 1-year warranty. CE certified.

SKU	Description	UOM	Price
286717-2175	Dynamometer Hydraulic Hand Baseline® 200 pounds	EA	\$325.00

**C. Theraputty™**

Theraputty is great for improving hand-muscle strength and increasing endurance. Exercising with the putty promotes increased range of motion, hand closure and tendon gliding. Each color represents a different resistance, from XX- soft (tan) to firm (blue).

SKU	Description	UOM	Price
2867382013	Theraputty 2 oz xx-soft (tan)	EA	\$3.67
2867382013S	Theraputty 2 oz x-soft (yellow)	EA	\$3.67
2867382013SM	Theraputty 2 oz soft (red)	EA	\$3.67
2867382013MF	Theraputty 2 oz medium (green)	EA	\$3.67
2867382013F	Theraputty 2 oz firm (blue)	EA	\$3.67



**D. Therabath® PRO®**

Therabath PRO Paraffin Bath provides intensive moisture therapy that nourishes the skin. The penetrating heat relieves aching joints and work-weary hands.

SKU	Description	UOM	Price
67151106	Therabath Pro paraffin bath w/wintergreen wax	EA	\$213.82
67150101	Therabath Pro wax beads 6 lb unscented	BX	\$27.32
67150100	Therabath Pro paraffin wax beads 6 lb wintergreen	BX	\$27.32





**A**

### A. Ascensia® Contour®

The Ascensia Contour System automatically corrects for common variables that affect accuracy. The system requires no coding and provides automatic under fill detection, automatic control marking and automatic temperature control. It requires a small sample size (0.6 uL) and gives results in 5 seconds. The last 480 test are saved along with the time and date they were performed and this information can be downloaded to your computer using Ascensia Glucofacts® Diabetes Software. Cleared for multiple site testing.

SKU	Description	UOM	Price
0193-7151-01	Ascensia Contour System	EA	\$25.12
0193-7080-50	Ascensia Contour Test Strips 50/BT	EA	\$92.15

### B. ACCU-CHEK® Compact Plus meter system

The only one that's all-in-one, the ACCU-CHEK Compact Plus meter is the only blood sugar monitor with all-in-one convenience. Brightest display - easy to read, the big, glow-in-the-dark screen helps in poor lighting. Load-and-go drum of 17 preloaded test strips. No more struggling with individual strips. And no coding means fewer steps. Detachable lancing device, the ACCU-CHEK Softclix Plus lancing device offers the least-painful lancing technology, with 11 customizable depth settings for different skin types.

SKU	Description	UOM	Price
50924-019-01	ACCU-CHEK Compact Plus Glucose Kit	EA	\$100.50



**B**



**C**

### C. OneTouch® SureSoft™

Create an almost feather-soft experience for your diabetes patients with the OneTouch SureSoft Lancing Device. Our single-use lancing devices are electro-polished, which results in a smoother, more comfortable entry than an acid-washed needle. This means you can use a smaller gauge needle while still ensuring that a sufficient blood sample will be drawn for point-of-care testing.

SKU	Description	UOM	Price
3885-0140-20	OneTouch SureSoft Lancet 200/BX	BX	\$64.12

### D. MicroLets®

Microlet Sterile Lancets are Sterile lancets for use with Microlet Automatic Lancing Device.

SKU	Description	UOM	Price
0193-6546-21	Microlet sterile blood lancets 100/BX	BX	\$14.63

**D**



**E**

### E. Softclix®

The Accu-Chek Softclix Lancet Device is the lancet device that minimizes discomfort. With a Comfort Dial and lancet depth selection this device provides greater adjustability with 11 depth settings.

SKU	Description	UOM	Price
5092-0957-01	Accu-Chek Softclix device	EA	\$42.43
5092-4585-10	Lancets soft-touch 100/BX	BX	\$13.22

### A. In-Line Strep A Test

The QuickVue In-Line® Strep A Test is a one-step test that rapidly detects group A streptococcal antigen from patient throat swab specimens. The testing can take place at the point of care due to the unique in-line extraction design.

SKU	Description	UOM	Price
QUI0343	QuickVue In-Line Strep A 25 Test/BX	BX	\$145.60



### B. One-Step Pregnancy Test

The QuickVue® One-Step hCG Urine test is a sensitive immunoassay for the qualitative detection of human chorionic gonadotrophin (hCG) in urine for the early detection of pregnancy.

SKU	Description	UOM	Price
QUI0258	QuickVue One-Step hCG Urine 25 Test/BX	BX	\$67.97

### C. Influenza Test

The QuickVue® Influenza test provides you with test results that allow you to Test and Treat in less than 10 minutes. Each kit contains everything needed to perform the test, including both positive and negative controls.

SKU	Description	UOM	Price
QUI00317	QuickVue Influenza 25 Test/BX	BX	\$694.05

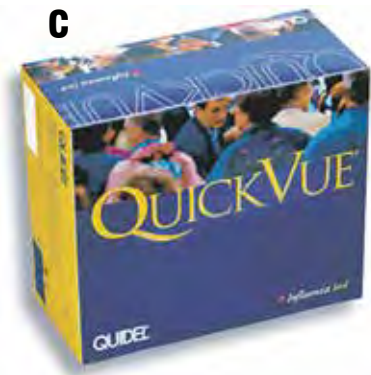

### D. Chemstrip® 10 SG Strips

Chemstrip 10 SG tests for bilirubin, blood, glucose, ketones, leukocytes, nitrite, pH, protein, specific gravity and urobilinogen in urine. Designed to be more absorbent, ChemStrip Urine Test Strips virtually eliminates reagent run over, and promotes rapid sample diffusion for distinct uniform color changes. Also, the exclusive design of the glucose and blood reagent pads integrates an additional layer permeated with iodate which oxidizes any ascorbic acid. All of this assures efficient, accurate results you can use to screen your patients before problems arise and become costly.

SKU	Description	UOM	Price
5092-4145-10	Chemstrip 10 SG urine test strips 100/BT	BX	\$77.23





### A. Draeger Alcotest® 6810 For DOT

The Draeger Alcotest 6810 was designed through practical experience and input from professionals around the world. The Alcotest 6810 for DOT firmware was developed specifically for the Department of Transportation Workplace Testing. Special lockout features ensure that the instrument is compliant with DOT regulations. The handheld and printer are completely mobile with no wires or cords required for operation. **Training is required prior to purchase and usage of this device.**

SKU	Description	UOM	Price
DRA4416811	Alcotest 6810 Kit I (Basic Kit as described below)	EA	\$2792.10
DRA4416812	Alcotest 6810 Kit II (Basic Kit, plus CalGAZ 105L dry gas cylinder and 12L regulator)	EA	\$3290.38
DRA4416813	Alcotest 6810 Kit III (Basic Kit, plus CalGAZ 34L dry gas cylinder and 12L regulator)	EA	\$3204.47

The basic ALCOTEST 6810 KIT contains a small carrying case, ALCOTEST 6810, ALCOTEST 6810 Mobile Printer, 100 mouthpieces, 2 rolls of thermal printer paper, 1 roll of tamper evident tape, calibration mouthpiece adaptor, 6 AA batteries, 1 year warranty and accuracy log sheets.

### B. Alcotest® 7410 Plus Kit II Accessories

These accessories are designed to go with the Alcotest 7410 Plus DOT.

SKU	Description	UOM	Price
DRA1005	7410 tamper indicator tape 1" x 108'	EA	\$35.62
DRA6805700	7410 mouthpieces	BG	\$9.86
DRA4599129	7410 printer paper rolls 5/BX	BX	\$13.51
DRA8100284	Printer ribbon	EA	\$11.17



### C. Certified Alcohol Solution

This certified alcohol solution is a water, ethanol mix that has been designed to yield specific BrAC reading on a breath testing device.

SKU	Description	UOM	Price
DRA4507060	Certified alcohol solution 0.040% 500ml x 2	BX	\$28.87
DRA4507061	Certified alcohol solution 0.10% 500ml each	EA	\$14.43
DRA4507062	Alcohol calibration gas 0.04% 105 liter	EA	\$255.58

### D. Alcohol Testing Form

The Department of Transportation Alcohol Testing form must be used each time a test is administered by an employer participating in the DOT alcohol testing program.

SKU	Description	UOM	Price
DRA1004	Alcohol D.O.T. three part form 100/PK	PK	\$48.12



**A. Q.E.D.® Saliva Alcohol Test**

The Q.E.D. Saliva Alcohol Test is a rapid, low-cost alternative to breath or blood testing. The test is easy to operate and provides quantitative results as accurate as a blood test.

SKU	Description	UOM	Price
STC31150B	Q.E.D. saliva alcohol test, A150 10/BX	BX	\$130.00



**B. ALCO-Screen™**

Alco-Screen alcohol test sticks are plastic strips tipped with a reagent pad. The reagent tipped end is inserted into the mouth and saturated with saliva. Once saturated, the stick is removed from the mouth and within two minutes the test result can be interpreted. Test results show through varied color blocks increments of 0.02%, 0.05%, 0.1% and 0.3%.

SKU	Description	UOM	Price
CHE55001-25	Alco-Screen alcohol test stick 24/BX	BX	\$42.10

**C. Accutest SplitCup 5**

Drug test results in 5 minutes or less. No exposure to urine. Stores at room temperature. SAM-HSA cutoffs. Built-in controls to validate results. Test starts when you push the key; reduces opportunity to tamper. Flat surface makes photocopying results easy.

SKU	Description	UOM	Price
DS03AC625	Accutest 5 panel (A,C,O,PCP,THC)	25/BX	\$208.38
DS02AC625	Accutest 5 panel (A,C,M,O,THC)	25/BX	\$208.38



**D. Accutest - Drug Test Cup 5 with Adulteration Screen (Urine)**

No-step multiple-panel drug screen with hygienic self-contained cup format. Easy collection, results in 5 minutes and easy to read results. No reagents needed. Stores at room temperature. Built-in control to validate results.

SKU	Description	UOM	Price
DS84	Drug Test Cup 5 with Adulteration Screen (A,C,M,O,THC) 24/BX	BX	\$280.00



### A. Temp Strip Specimen Container

This specimen container is non-sterile and holds up to 6.5 oz.; great for urine samples. Has a temperature strip and no lid.

SKU	Description	UOM	Price
GBFKMEDSAFE	Specimen cup 6.5 oz temp strip no lid 500/CS	CS	\$228.07

### B. Snap Cap Specimen Container

This specimen container is non-sterile and holds up to 5 oz.; great for urine samples.

SKU	Description	UOM	Price
614112500	Specimen container 5 oz w/ plastic snap cap 400/CS	CS	\$140.66



### C. Blue Toilet Tablet for Drug Testing

Toilet Bluing Solution. Eliminate the adulteration of urine sample by substituting toilet water for the urine sample. Easy to use! Flush toilet and when fresh water enters bowl, dispense one True Blue tablet. One tablet instantly turns the toilet bowl or tank water blue.

SKU	Description	UOM	Price
SASITB1	Blue Toilet Tablet for drug testing 100/BT	BT	\$23.25

### D. Mrs. Stewart's® Liquid Bluing

Mrs. Stewart's Liquid Bluing, longtime, earth-friendly fabric whitener, also used to color toilet water for drug testing.

SKU	Description	UOM	Price
9999-08	Mrs. Stewart's Liquid Bluing 8 oz	EA	\$3.62





### A. Defender® 5 Gallon Waste Can

The Defenders medical step cans conform to OSHA standards on bloodborne pathogens for the safe containment of infectious waste and comply with OBRA Regulations. Durable powder coated galvanized steel construction is UL Listed/Factory Mutual Systems Approved fire-safe/self-extinguishing. Retainer bands hold poly-bags securely within galvanized steel liner. Vinyl base ring protects floors.

SKU	Description	UOM	Price
6508ST5	Defender waste can 5 GA (11" x 22") red	EA	\$84.59

A



B

### B. Defender® 24 Gallon Waste Can

The Defenders medical step cans conform to OSHA standards on bloodborne pathogens for the safe containment of infectious waste and comply with OBRA Regulations. Constructed of durable powder coated galvanized steel. UL Listed/Factory Mutual Systems Approved fire safe/self-extinguishing. Retainer bands hold poly-bags securely within unit while piano hinged lid has restraint mechanism to prevent damage to walls and equipment.

SKU	Description	UOM	Price
6508ST24ERB	Defender waste can 24 GA (15" x 30")OPT-RB/CL1	EA	\$184.95

### C. Biohazard Bag

Prevent the risk of cross contamination with hazardous materials during collection and transport by using a biohazard waste bag. Available in various sizes.

SKU	Description	UOM	Price
WINRD650	Biohazard bag red 16" x 24" 200/CS	CS	\$26.28
WIN116M	Biohazard bag red 23" x 23" 500/CS	CS	\$83.88
WIN108M	Biohazard hamper bag red 25" x 34" 250/CS(13-16 GA)	CS	\$58.25
WIN117M	Biohazard hamper bag red 30-1/2" x 41" 250/CS 20-30 GA	CS	\$85.52

C



D

### D. Melt-Away Bag

These water-soluble bags help with infection control when doing laundry. The bag isolates the contaminated laundry until the water is hot enough to sterilize it and then the bag dissolves.

SKU	Description	UOM	Price
WIN809	Bag Melt Away 30 GA hot H2O soluble clear 100/CS	CS	\$113.16



**A**

### A. Protectaide Biohazard Kit

When cleaning up spills it is important to protect yourself, the spill clean up kit helps you do just that.

SKU	Description	UOM	Price
PRTB3069-N	Protectaide biohazard clean-up kit	EA	\$5.22
PRT24592L	Protectaide Pack gown/glove/mask/bag/wipe	EA	\$10.32

### B. Precaution Kit

Universal Precaution Kit Combination Protection/Clean-up Kit. Contains items mandated by OSHA, CDC and state health departments, to aid in the cleanup, transportation and disposal of up to 1 liter of infectious blood or body fluid spills.

SKU	Description	UOM	Price
436117100	Red Z universal precaution kit	EA	\$10.74
REDZ48036	Universal precaution kit, hard plastic case	EA	\$17.18



**B**



**C**

### C. EZ-Clean Kit

EZ-Clean Plus Kit Spill Cleaner Upper. A responsible method for the clean up of potentially infectious and harmful blood and body fluid spills. Minimizes cross contamination. Safe, convenient, effective and inexpensive. Kit contains: Red Z pouch, gloves, pick-up scoop with scraper, antimicrobial hand wipe, germicidal disinfectant with dry wipe, disposable bag (red or white) with twist ties, instructions- universal and easy to follow.

SKU	Description	UOM	Price
436117121	Red Z EZ clean plus kit	EA	\$5.96

### D. AbsorbAide

AbsorbAide helps to clean up harmful spills by solidifying liquids.

SKU	Description	UOM	Price
PRT108P-16-8	AbsorbAide inactivated phenolic 15 oz shaker	EA	\$12.43

**D**



**A. CaviCide®**

CaviCide is a convenient, ready-to-use, intermediate-level disinfectant that is effective against both TB and HBV. A disinfectant, cleaner and decontaminant in one, it is compatible with most medical device material and is safe for use on non-porous surfaces, even in neonatal and infant care areas.

SKU	Description	UOM	Price
670131024	Cavicide Disinfectant 24 oz bottle	EA	\$11.27
670131000	Cavicide Disinfectant 1 gallon	EA	\$32.08



**A**



**B**

**B. MetriCide Plus 30®**

MetriCide Plus 30 is a long life 3.4% buffered glutaraldehyde. It is the extra-strength solution for the sterilization and disinfection of immersible medical and dental equipment and instruments.

SKU	Description	UOM	Price
670310-3205	MetriCide Plus 30 quart	EA	\$10.46
670310-3200	MetriCide Plus 30 gallon	EA	\$27.90

**C. Envirocide®**

Envirocide is a convenient, ready-to-use, intermediate-level disinfectant that is effective against both TB and HBV. A disinfectant, cleaner and decontaminant in one, it is compatible with most medical device material and is safe for use on non-porous surfaces, even in neonatal and infant care areas.

SKU	Description	UOM	Price
670330024	Envirocide Disinfectant 24 oz spray bottle	EA	\$12.67
670330128	Envirocide Disinfectant 1 gallon	EA	\$38.58



**C**



**D**

**D. Sani-Cloth™**

The Sani-Cloth HB is great for disinfecting non-porous hard surfaces. The cloth is the first germicidal wipe that kills the Hepatitis B virus, along with 100 other organisms, including MRSA, VRE, E coli and HIV-1.

SKU	Description	UOM	Price
DYNQ77272	Sani-Cloth 6" x 6-3/4" large 160/CO	EA	\$10.44
DYNU87295	Sani-Cloth individual foil pack 50/BX	BX	\$37.48
DYNPQ89072	Sani-Cloth Plus large 160/CO	EA	\$10.30
DYNQ28572	Sani-Cloth Plus extra large 11" x 12" 65/CO	EA	\$12.59
DYNP-Q08472	Sani-Cloth HB 6" x 6-3/4" 160/CO	EA	\$10.57





**A**

### A. 2000 Flushes®

For continuous toilet bowl cleaning, choose 2000 Flushes Blue Plus Bleach. It uses chlorine to bleach away stains and powerful blue detergents to freshen with each flush. Easy to use, just drop the tab in the tank and it cleans for up to 4 months.

SKU	Description	UOM	Price
4173720001	2000 Flushes blue chlorine	EA	\$8.75

**B**



### B. Clorox® Bleach

Clorox Bleach can be used to sanitize and disinfect almost any surface at home or in the office.

SKU	Description	UOM	Price
LAG00128	Clorox Liquid 1 gallon	EA	\$13.45



**C**

### C. Clorox Disinfecting Wipes

Clorox® Disinfecting Wipes are wet household wipes that are pre-moistened with cleaners and disinfectants so they're ready to use. They can be used on most hard, non-porous surfaces, just wipe the surface and let air dry.

SKU	Description	UOM	Price
CLO01593	Clorox Disinfecting Wipes	EA	\$5.68

### D. Ivory®

Ivory Dishwashing Liquid attacks grease while being gentle on the hands.

SKU	Description	UOM	Price
9999-1209-81	Ivory Dish liquid 19 oz bottle	EA	\$7.77

**D**



### A. Benzalkonium Chloride Towelettes

Benzalkonium chloride towelettes can be used for general antiseptic cleansing for patients and staff. Each crepe towelette is saturated with benzalkonium chloride 1:250. Contains no alcohol.

SKU	Description	UOM	Price
TRI10-5201	Benzalkonium chloride towelettes 100/BX	BX	\$2.92



### B



### B. PCMX Scrub Brush

Preoperative cleaning of healthcare personnel arms and hands.

SKU	Description	UOM	Price
BP371163	Scrub brush easy scrub w/PCMX 30/BX	BX	\$49.19

### C. Betadine® Microbicides

Betadine Solution contains 10% povidone-iodine and helps reduce bacteria that potentially can cause skin infection. Betadine Surgical Scrub is a sudsing cleanser that contains 7.5% povidone-iodine. Povidone-iodine, the active ingredient in Betadine Microbicides, is capable of killing most gram-positive and gram-negative bacteria, including antibiotic-resistant strains, as well as most viruses, fungi/yeasts, mycobacteria and protozoa.

SKU	Description	UOM	Price
0034-2310-33	Betadine aerosol spray 3 oz can	EA	\$18.64
0034-2100-40	Betadine solution 4 oz bottle	EA	\$4.05
0034-2100-89	Betadine solution 8 oz bottle	EA	\$4.60
0034-2100-87	Betadine solution 16 oz bottle	EA	\$7.65
0034-2100-90	Betadine solution 32 oz bottle	EA	\$15.18
0034-2100-01	Betadine solution gallon	EA	\$51.58
0034-2200-04	Betadine surgical scrub 4 oz bottle	EA	\$5.88
0034-2200-89	Betadine scrub w/pump 16 oz bottle	EA	\$11.58
0034-2200-88	Betadine surgical scrub no pump 16 oz bottle	EA	\$6.96
0034-2200-90	Betadine surgical scrub 32 oz bottle	EA	\$14.36
0034-2200-01	Betadine surgical scrub gallon	EA	\$54.59



### D



### D. DERMA CIDOL/DERMA SCRUB

Gentle enough for frequent use, this antimicrobial hand wash is formulated with 0.5% PCMX (P-Chloro-M-Xylenol) to suppress a broad spectrum of microorganisms. Derma Scrub Professional Creme Soap Formula, as shown, easily removes soil and transient microorganisms to help prevent the transmission of infectious disease.

SKU	Description	UOM	Price
451501683	Derma Cidol/Derma Scrub	EA	\$59.72



**A**

### A. Tape Remover Pads

The Adhesive Tape Remover Pads leave the skin free of tape and its residue. The non-woven pads are non-irritating and use soothing liquids that are free of harsh chemicals to get the job done.

SKU	Description	UOM	Price
TRI10-6300	Adhesive tape remover pads 100/BX	BX	\$4.15

### B. Nail Polish Removal Pads

Nail polish remover pads are acetone free and used for removing nail polish on patients.

SKU	Description	UOM	Price
TRI10-6200	Nail polish removal pads, 100/BX	BX	\$3.80

**B**



**C**

### C. Alcohol Prep Pads

Primarily used as a topical antiseptic, anti-infective prior to administering injections. Each soft, absorbent, non-woven pad is impregnated with 70% Isopropyl Alcohol, USP.

SKU	Description	UOM	Price
TRI10-3001	Alcohol Prep Pads, Medium 200/BX	BX	\$2.31
TRI10-3002	Alcohol Prep Pads, Large 100/BX, 10/CS	CS	\$25.38

### D. Benzalkonium Chloride Alcohol Antiseptic Wipes

Antiseptic towelettes with benzalkonium chloride help prevent the risk of skin infections. This is a soothing pre-moistened antiseptic towelette for which can be used on the face and hands. These towelettes clean and cool simultaneously. Can be used as a first aid antiseptic to help prevent infection in minor cuts, scrapes and burns.

SKU	Description	UOM	Price
TRI10-5101	Benzalkonium chloride alcohol antiseptic wipes, 100/BX	BX	\$2.81

**D**



**E**

### E. Povidone Iodine

Povidone iodine has a generous foaming action that helps loosen foreign matter on skin.

SKU	Description	UOM	Price
TRI10-4402	Povidone iodine swabstick triples, 25/BX	BX	\$6.46
TRI10-4401	Povidone iodine swabstick singles, 50/BX	BX	\$6.86
TRI10-3201	Povidone iodine prep pads, 100/BX	BX	\$4.47
TRI10-8316	Povidone iodine scrub solution, 16 oz bottle	EA	\$9.82
TRI10-8228	Povidone iodine prep solution, gallon	EA	\$37.75
TRI10-8216	Povidone iodine prep solution, 16 oz bottle	EA	\$3.80
TRI10-8328	Povidone iodine scrub solution, gallon	EA	\$28.60



### A. Isopropyl Alcohol

This is the ideal solution for your first aid antiseptic needs. Cut down the risk of infection from minor cuts, burns and scrapes.

SKU	Description	UOM	Price
0869-1156-10	Alcohol 70% isopropyl 16 oz bottle	EA	\$1.84
70418-01206	Alcohol isopropyl 70% 4 oz spray pump	EA	\$2.62
0869-1157-10	Alcohol 99% isopropyl gallon	EA	\$63.86

A



B

### B. Peroxide

For use as a topical anti-infective solution to clean minor cuts and abrasions.

SKU	Description	UOM	Price
0869-4704-10	Peroxide 3% UPS 8 oz bottle	EA	\$7.79
0869-4706-10	Peroxide 16 oz bottle	EA	\$8.81
70418-01282	Peroxide 3% spray 4 oz pump	EA	\$2.19

### C. Hibiclens® Liquid

Hibiclens antiseptic, antimicrobial skin cleanser for added protection against offending molecules and germs. Easy-to-open bottle. Active ingredients are chlorhexidine gluconate and isopropyl alcohol.

SKU	Description	UOM	Price
0038-0575-04	Hibiclens Liquid 4 oz bottle	EA	\$7.07
0038-0575-16	Hibiclens Liquid 16 oz bottle	EA	\$15.93
0038-0575-32	Hibiclens Liquid 32 oz bottle	EA	\$19.67
003870575-91	Hibiclens Liquid 1 gallon (128 oz)	EA	\$72.02

C



D

### D. Dial®

Liquid Dial® Gold Antimicrobial Hand Soap has broad spectrum antimicrobial effectiveness with added skin conditioners for mildness.

SKU	Description	UOM	Price
1700-0007-61	Dial Antibacterial Liquid Soap w/pump 7.5 oz bottle	EA	\$3.91
840-4810	Dial Antibacterial Soap, gallon	EA	\$21.53

### E. Vionex® Antimicrobial Soap

Gentle to the skin and formulated for frequent, non-irritating use, Vionex Soap effectively kills pathogenic microorganisms while it reduces the risk of cross-contamination.

SKU	Description	UOM	Price
670325017	Vionex Soap w/pump 18 oz bottle	EA	\$11.49
670325128	Vionex Antimicrobial Soap gallon	EA	\$39.89
670325100	Vionex Wipes, 50/BX	BX	\$11.60

E





**A**

### A. P.A.W.S. Hand Wipes

Paws wipes kill 99.99% of germs in 15 seconds without the use of soap and water. Paws contains 66.5% Ethyl Alcohol for antimicrobial action and aloe vera to add moisture with each use. Using paws wipes helps you to reduce the risk of cross-contamination and helps you comply with CDC and OSHA hand washing recommendations.

SKU	Description	UOM	Price
436117136	PA.W.S. Antibacterial Hand Wipes 100/BX	BX	\$5.58

### B. Antiseptic Bio-Hand Cleaner

Water-less bio-hand sanitizer kills 99.9% of germs instantly.

SKU	Description	UOM	Price
4768-2511-73	Antiseptic Bio-Hand Cleaner	BX	\$3.72

**B**



**C**

### C. Hand Sanitizer

Water-Jel hand sanitizer kills 99.9% of germs - without water. Unit Dose Packets to avoid cross contamination.

SKU	Description	UOM	Price
WJHS1800	Hand sanitizer 1/32 oz unit dose 25/BX	BX	\$3.01
WJHS1728	Hand sanitizer 1/32 oz unit dose 144/BX	BX	\$10.91
WJHS2-24	Hand sanitizer 2 oz. squeeze bottle	EA	\$1.72

### D. Avant Original Instant Hand Sanitizer

Clinically proven to kill 99.99% of a broad spectrum of microorganisms in 15 seconds without soap and water. Kills MRSA! 95% bio-based. Hydrates skin with natural glycerin, vitamin A, and vitamin E and is clinically proven to be non-irritating, even in frequent use environments. Powered by 60% grain-based ethanol, a renewable natural resource, leaves hands feeling clean and refreshed without the strong smell of perfume or alcohol. Meets FDA protocol for Healthcare Personnel Hand wash and free of irritating dyes or colorants. CHG and latex compatible.

SKU	Description	UOM	Price
B4B12089-16	Avant hand sanitizer 60% ethanol 16oz with pump	EA	\$5.14

**D**



**E**

### E. Citrus II® Hand Sanitizer

Citrus II® Instant Hand Sanitizing Lotion is a moisture-rich gel that kills 99% of most common disease-causing germs on the hands in seconds. Citrus II is ideal to use when soap and water hand washing is not available. For extra safety, it should be used after hand-washing to kill any remaining germs.

SKU	Description	UOM	Price
CIT632712949	Citrus II Hand Sanitizing Lotion 32 oz bottle with pump (62% Alcohol)	EA	\$14.71
CIT7760	Citrus II Hand Sanitizing Lotion 8 oz bottle (62% Alcohol)	EA	\$3.87



**A. SBS™ UltraGreen Antibacterial Gel**

Antibacterial, rich lathering gel soap, 99.99% effective on most common bacteria. High-quality, mildly scented. Contains triclosan. Use anywhere an antibacterial benefit is needed.

SKU	Description	Size	UOM	Price
DEBS75107	SBS UltraGreen	2 liter	EA	\$12.01

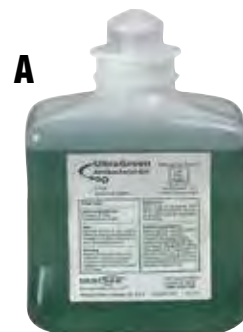

**B. InstantFOAM™ Alcohol and Non-Alcohol Hand Sanitizers**

NEW Deb InstantFOAM alcohol hand sanitizer and InstantFOAM non-alcohol hand sanitizers utilize the power of Deb Foam Technology®. With no sticky gelling agents or water required, the unique and refreshing foam formulas sanitize hands quickly and effectively.

SKU	Description	Size	UOM	Price
DEB01801	Instant Foam Alcohol (72% Alcohol with Moisturizers)	47ml / 1.6oz	EA	\$3.95
DEB01815	Instant Foam Alcohol (72% Alcohol with Moisturizers)	400ml / 13.5oz	EA	\$11.85
DEB01827	Instant Foam Alcohol (72% Alcohol with Moisturizers)	1L	EA	\$18.53
DEB55851	Instant Foam Free Non-Alcohol	50ml / 1.7oz	EA	\$3.95
DEB55815	Instant Foam Free Non-Alcohol	400ml	EA	\$11.75
DEB55857	Instant Foam Free Non-Alcohol	1L	EA	\$12.78
DEB98127	Proline dispenser- white Fits all 1 liter cartridge	1L	EA	\$8.90

**C. Epi San™**

Epi San is a convenient no rinse sanitizer that will eliminate most common disease causing organisms in 15 seconds. Epi San is 62% alcohol with aloe vera and is scented. It has DEB SBS enhanced moisturizing formulation, and are compatible with DEB SBS creams and lotions. Epi San is effective against MRSA & VRE.

SKU	Description	Size	UOM	Price
DEBS01127	Epi San ProLine® Instant Sanitizing Gel (62% Alcohol) - With aloe vera	1L	EA	\$12.27

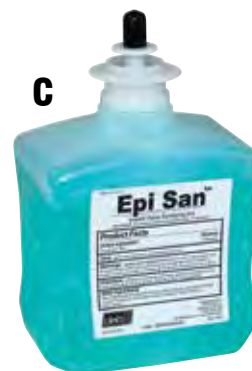

**D. Epi San™ with Extra Care**

Epi San with Extra Care effectively reduces the risk of cross contamination and pathogenic organisms. Epi San with Extra Care meets established CDC Guidelines, and eliminates 99.99% of common germs and bacteria. It is formulated with 64% Ethyl Alcohol, then enriched with conditioners and moisturizers including Aloe Vera, Jojoba Oil, Vitamin E, Lanolin and Allantoin. This non-greasy, lightly scented and fast drying sanitizer is ideal for high use facilities and is effective against MR MRSA and VRE bacteria.

SKU	Description	Size	UOM	Price
DEB01119	Epi San with Extra Care sanitizing gel pump	16 oz	EA	\$5.85
DEB01125	Epi San with Extra Care sanitizing gel	1L	EA	\$12.18

**E. Purell®**

Purell hand sanitizer kills 99.9% of most disease causing germs within 15 seconds. This sanitizer can be used to supplement routine hand washing. It can also be used whenever soap and water are unavailable.

SKU	Description	UOM	Price
GOJ09651-1	Purell Hand Sanitizer 4 oz bottle	EA	\$3.27
GOJ09651	Purell Hand Sanitizer 4 oz 24/CS	CS	\$78.47
GOJ09625-04	Purell Hand Sanitizer 2L with pump	EA	\$39.67







**A**

### A. Alcohol Gel

Alcohol Gel is the instant solution to the problem of sanitizing hands without soap, water or the use of towels. Our “no rinse” formulation is ideal for use when patient contact is frequent, but soap and water are not readily available. Triad alcohol gel is recommended for repeated use to sanitize your hands. It conditions your skin with aloe vera and will leave you clean and freshly scented. This fast acting gel is waterless and leaves no sticky residue. Triad alcohol gel is thicker than alcohol liquids and thus more easily managed. Simply rub the gel into the skin until dry.

SKU	Description	UOM	Price
TRI10-8604	Alcohol gel 4 oz bottle	EA	\$1.28

### B. Jergens® Lotion

Jergens Original Scent Cherry-Almond Lotion moisturizes and leaves your skin looking and feeling soft and healthy. This lotion penetrates beneath the surface of dry skin to help heal it from within.

SKU	Description	UOM	Price
1903-51	Jergens Lotion advanced formula original scent 10 oz bottle	EA	\$5.57



**B**



**C**

### C. Keri® Lotion

Keri Lotion soothes, moisturizes and protects skin against dryness. It is specially balanced for sensitive skin.

SKU	Description	UOM	Price
0072-5501	Keri Lotion 2 oz bottle	EA	\$ .90
3198-1300-62	Keri Lotion orig 8.5 oz	EA	\$7.22

### D. Lubriderm® Daily Moisture Lotion

Developed by dermatologists for healthier skin, Lubriderm Daily Moisture Lotion provides essential moisturizing elements that your skin needs. Its unique formula with a patented emollient penetrates dry skin to effectively moisturize without leaving a greasy feel.

SKU	Description	UOM	Price
5280-0488-16	Lubriderm Daily Moisture Lotion unscented 6 oz bottle	EA	\$4.30
5280-0488-56	Lubriderm Daily Moisture Lotion unscented 16 oz pump	EA	\$11.53



**D**



**E**

### E. VioNex® Skin Lotion

Vionex Skin Lotion is fortified with a blend of emollients and provides dry skin relief for frequently washed hands. Lotion does not contain mineral oil or petrolatum, which break down latex. It is not greasy and does not interfere with gloving.

SKU	Description	UOM	Price
6703101318	Vionex skin lotion 18 oz	EA	\$13.68

**A. 2nd Skin®**

This revolutionary hydrogel dressing helps protect against blisters, pressure and friction. Helps bring cooling relief to stings, bites, poison ivy and blisters. Comes in five packages for a variety of applications.

SKU	Description	UOM	Price
596510-637	2nd Skin® dressing 1" x 1" 200/Jar	JR	\$24.33
596510-603	2nd Skin® dressing 3" 48/Jar	JR	\$36.18
596547-019	2nd Skin® dressing - Sterile 2" x 3" 4/BX	BX	\$6.58
596547-209	2nd Skin® sterile dressing kit: 2-3" x 6-1/2", 1-3" x 5", 5-3" x 1-1/2"	BX	\$8.54
596547-027	2nd Skin® sterile dressing 3 x 4 3/BX	BX	\$6.58



**B. ADAPTIC\* Non-Adhering Dressings**

ADAPTIC Dressing is a primary dressing made of knitted cellulose acetate and impregnated with a specially formulated petrolatum emulsion designed to protect the wound. ADAPTIC Dressing is ideal for moderate to heavily exuding wounds.

SKU	Description	UOM	Price
34602012	Adaptic non-adhering dressing 3" x 3" sterile, 50/BX	BX	\$41.98
34602014	Adaptic non-adhering dressing 3" x 16" sterile, 36/BX	BX	\$98.28
34602015	Adaptic non-adhering dressing 3" x 8" sterile, 24/BX	BX	\$48.27

**C. VASELINE® Gauze**

The VASELINE Petrolatum Gauze dressing is a sterile bandage and dressing in one. This unique gauze dressing effectively protects the wound from contamination and impregnated with white petrolatum for non-adherence.

SKU	Description	UOM	Price
8884413605	VASELINE Gauze sterile 3" x 9" 50/BX	BX	\$64.78



**D. 3M™ Tegaderm™ Transparent Dressings**

Tegaderm transparent dressings consist of a thin polyurethane membrane coated with a layer of an acrylic adhesive. The dressing, which is permeable to both water vapor and oxygen, is impermeable to micro-organisms once in position.

SKU	Description	UOM	Price
43181624W	Tegaderm 2-3/8" x 2-3/4" 100/BX	BX	\$73.98
43181624	Tegaderm Dressing 2-3/8" x 2-3/4" 8/BX	BX	\$7.69

**New-Skin®**

Try New-Skin Spray for large areas on legs and arms. New-Skin Liquid is suited for smaller areas. New-Skin dries rapidly to form a touch, protective cover that is antiseptic, flexible, waterproof and lets skin breathe. Completely covers the entire wound to keep out dirt and germs.

SKU	Description	UOM	Price
740-10	New Skin Spray bandage 1 oz	EA	\$6.70
7513-7703-31	New Skin Liquid bandage 1 oz	EA	\$6.70



### A. Gauze Pads

Sterile gauze pads singles are highly absorbent and individually packaged. For added convenience they are packed in handy dispenser boxes.

SKU	Description	UOM	Price
63612040	Steri-Pads 12 ply 2" x 2" 100/BX	BX	\$2.63
63612041	Steri-Pads 12 ply 3" x 3" 2/PK 80/BX	BX	\$3.74
63612042	Steri-Pads 12 ply 4" x 4" 100/BX	BX	\$6.02

### B. Gauze Sponges

Surgical dressings combine superior quality with assured economy. 100% cotton for maximum absorption, these sponges are ideal for a wide range of dressing, cleaning and prepping procedures. The cut edges of the surgical sponges are folded in leaving no exposed raw edges.

SKU	Description	UOM	Price
63611M827	Sponge 2 x 2- 8 ply gauze non-sterile 200/BG	BG	\$1.19
63611861	Sponge 2 x 2- 12 ply gauze non-sterile 200/BG	BG	\$1.38
63611M830	Sponge 3 x 3- 12 ply gauze non-sterile 200/BG	BG	\$2.89
63611M831	Sponge 4 x 4- 8 ply gauze non-sterile 200/BG	BG	\$3.64
63611M832	Sponge 4 x 4- 12 ply gauze non-sterile 200/BG	BG	\$5.09
35836939	Sponge 4 x 4- 12 ply gauze sterile 10/PK	PK	\$1.12

### B



### C. Flexicon® Conforming Stretch Bandage

Flexicon is a durable conforming stretch bandage that holds dressings securely in place without slipping. A unique filament structure and nap ensures Flexicon will cling to itself. Its uniform weave of rayon and polyester yarns create a strong gauze that stretches and conforms even to the most awkward and difficult-to-dress areas. Flexicon's woven edges also minimize lint and unraveling.

SKU	Description	UOM	Price
15872260	Flexicon conforming stretch bandage non-sterile 6" 6/BG	BG	\$6.18
15872210	Flexicon conforming stretch bandage non-sterile 1" 24/BG	BG	\$6.78
15872220	Flexicon conforming stretch bandage non-sterile 2" 12/BG	BG	\$4.25
15872230	Flexicon conforming stretch bandage non-sterile 3" 12/BG	BG	\$6.14
15872240	Flexicon conforming stretch bandage non-sterile 4" 12/BG	BG	\$7.43
15871910	Flexicon conforming stretch bandage-sterile 1" x 4 1/2 yd 12/BX	BX	\$6.65
15871920	Flexicon conforming stretch bandage-sterile 2" x 4 1/2 yd 12/BX	BX	\$6.95
15871930	Flexicon conforming stretch bandage-sterile 3" x 4 1/2 yd 12/BX	BX	\$9.16
15871940	Flexicon conforming stretch bandage-sterile 4" x 4 1/2 yd 12/BX	BX	\$10.95
15871960	Flexicon conforming stretch bandage-sterile 6" x 4-1/2 yd 12/BX	BX	\$15.86
15871820	Flexicon individually wrapped 2" x 1/2 yd 20/BX	BX	\$8.09
15871830	Flexicon individually wrapped 3" x 4 1/2 yd 20/BX	BX	\$11.98
15871840	Flexicon individually wrapped 4" x 4 1/2 yd 20/BX	BX	\$14.09



### C

### D. CONFORM® Bandages

CONFORM Stretch Bandages are made of a one-ply cotton/polyester blend crocheted bandage that provides softness, conformability, low lint and high absorbency. These bandages are ideal for securing dressings, IV's and splints or for providing mild compression or support. Holds securely to any body contour but allows for movement and some soft tissue swelling. Bandages stay in place with minimal taping.

SKU	Description	UOM	Price
35832230	CONFORM stretch bandage 1" x 4.1 yd sterile 12/BX	BX	\$11.14
35832231	CONFORM stretch bandage 2" x 4.1 yd sterile 12/BX	BX	\$10.10
35832242	CONFORM stretch bandage 2" x 4 yd non-sterile 12/BX	BX	\$4.66
35832244	CONFORM stretch bandage 3" x 4 yd non-sterile 12/BX	BX	\$5.86
35832232	CONFORM stretch bandage 3" x 4 yd sterile 12/BX	BX	\$11.12
35832247	CONFORM stretch bandage 4" x 4 yd non-sterile 12/BX	BX	\$9.11
35832236	CONFORM stretch bandage 4" x 4 yd sterile 12/BX	BX	\$13.35
35832238	CONFORM stretch bandage 6" x 4 yd sterile 12/BX	BX	\$19.31

### D





### A. KERLIX® Rolls

KERLIX Bandage Rolls are made of pre-washed, fluff-dried, 100% woven gauze with unique crinkle-weave pattern for loft and bulk to cushion and protect wound areas. The six-ply construction with finished edges reduces loose ends and lint. When used as a primary dressing, the open-weave design provides fast wicking action, superior aeration and excellent absorbency. As secondary dressing, it provides bulk, cushioning and ultimate conformability. Ideal for bandaging heads, limbs and difficult-to-dress wounds.

SKU	Description	UOM	Price
35833324	KERLIX non-sterile rolls 4-1/2" x 147" 12/BX	BX	\$34.96
35836720	KERLIX sterile 2-1/4" 6 ply roll	EA	\$1.05
35836715	KERLIX sterile rolls 4-1/2" 6 ply each	EA	\$2.28



A

B

### B. Bloodstopper® Trauma Dressing



This multipurpose wound and trauma dressing can be used in many ways including: Heavy External Bleeding - The bloodstopper includes an extra gauze roll that can be used as a pressure dressing. Surface Wound and Abrasions - By removing gauze roll use non stick surface to cover wounds. Burns - The expandable wound pad can be used to cover burns. Fractures - Bloodstopper can be used as a sling or to secure a splint.

SKU	Description	UOM	Price
CED1910	Bloodstopper wound dressing sterile	EA	\$2.89

### C. Cover Roll

Cover Roll is a non-woven bandage that provides wide area coverage over wounds and dressings. This bandage can be cut to size to secure virtually any dressing and is air permeable and hypoallergenic.

SKU	Description	UOM	Price
073045547	Cover roll stretch 2" x 2 yd	EA	\$3.95
073045548	Cover roll stretch 4" x 2 yd	EA	\$5.91
073045549	Cover roll stretch 6" x 2 yd	EA	\$7.87



C

D

### D. Adhesive Foam Pad



Self-adhering foam designed to distribute body weight to help prevent skin breakdown and pressure ulcers, and to prevent skin damage from splints, casts and prostheses. Self-adheres to casts, appliances and equipment. Removes easily. Conformable to protect against abrasions, shearing and pressure. Not recommended to be applied directly on skin as can cause adhesive irritation. It works well over dressings.

SKU	Description	UOM	Price
43181560M	Reston adhesive foam pads 8" x 12" 10/BX	BX	\$56.05

### E. Eye Pads

These latex free sterile eye pads are absorbent and help draw excess fluid from the eye. The oval shape fits the eye for better comfort and provides maximum protection from bright light and debris.

SKU	Description	UOM	Price
327117570	Eye pads oval sterile 1s Large 50/BX	BX	\$10.80
327117576	Eye pads oval sterile 1s 50/BX	BX	\$11.62



E



### A. TELFA® Pads

TELFA Ouchless Non-Adherent Dressings are absorbent cotton pad that won't disrupt healing tissue by sticking to wound. Each sterile dressing is individually wrapped in a peel-open envelope. These are ideal as a primary dressing for lightly draining wounds. They are bonded on both sides with perforated non-adherent film, and can be cut to any shape without separating.

SKU	Description	UOM	Price
35831238	TELFA Pads - sterile 8" x 3" 50/BX	BX	\$16.60
35831961	TELFA Pads - sterile 2" x 3" 100/BX	BX	\$13.48
35832132	TELFA Pads - sterile 3" x 4" 100/BX	BX	\$22.88
35836017	TELFA Pads - sterile adhesive 2" x 3" 100/BX	BX	\$16.40
35837643	TELFA Pads - sterile adhesive 3" x 4" 100/BX	BX	\$30.89

### B. Non-Adherent Pads

These non-adherent pads will protect the wound without sticking to it.

SKU	Description	UOM	Price
3277565033	Non-adherent pads - sterile, 2" x 3" 100/BX	BX	\$7.75
3277575033	Non-adherent pads - sterile, 3" x 4" 100/BX	BX	\$10.40
3277665033	Non-adherent pads with adhesive 2" x 3" 100/BX	BX	\$8.99
32777675033	Non-adherent pads with adhesive 3" x 4" 100/BX	BX	\$15.38



### C. Cotton Balls

Cotton balls are 100% cotton, soft and absorbent. They are designed for a variety of uses. Available in sterile and non-sterile packaging.

SKU	Description	UOM	Price
34606105	Cotton balls, 100/BG	BG	\$1.75
35832600	Cotton balls, non-sterile, medium 500/BG	BG	\$3.15
6358969153	Cotton balls, non-sterile, medium 2000/BG	BG	\$9.69
35832601	Cotton balls, non-sterile, large 200/BG	BG	\$2.73

### D. CURITY® LAKESIDE® Cotton Rolls

CURITY LAKESIDE Cotton Rolls are soft and absorbent. They are made of non-surgical bleached cotton, and are non-sterile.

SKU	Description	UOM	Price
35836030	Cotton roll LAKESIDE 1 lb/RL	RL	\$9.90



### E. Cotton Tip Applicator

Single ended cotton tipped applicators make them ideal for exam use.

SKU	Description	UOM	Price
3022803-WC	Cotton tip applicator - 3" wood 2/PK 100PK/BX	BX	\$8.02
3022258032WC	Cotton tip applicator - Sterile 3" wood 2/PK 100PK/BX	BX	\$4.80
3022806WC	Cotton tip applicator - 6" wood 12/PK 100PK/BX	BX	\$120.53
3022806WCL	Cotton tip applicator large tip 6" wood 500/BX	BX	\$7.04
3022258062W	Cotton tip applicator - sterile, 6" wood 2/PK 100PK/BX	BX	\$5.04

### A. Comperm® LF

Latex-free Comperm Tubular Elastic Bandage provides 360 degrees of uniform compression and support with minimal risk of constriction. Comperm's 100% cotton-knit tubular construction creates a bandage that's easy to apply and comfortable to wear. Comperm also stays in place without clips or tapes. Best of all, compression and support remain consistent even after re-application. Comperm offers superior support for edema reduction, post-cast support and as coverage for a wound dressing

SKU	Description	UOM	Price
15878401	Comperm tubular elastic bandage, size A 1-5/8" x 11 yd	EA	\$20.33
15878402	Comperm tubular elastic bandage, 2-1/2" x 11 yd	EA	\$26.75
15878403	Comperm tubular elastic bandage, 2-3/4" x 11 yd	EA	\$28.07
15878404	Comperm tubular elastic bandage, 3" x 11 yd	EA	\$28.67
15878405	Comperm tubular elastic bandage, 3-1/2" x 11 yd	EA	\$30.09
15878406	Comperm tubular elastic bandage, 4" x 11 yd	EA	\$34.11
15878407	Comperm tubular elastic bandage, 5" x 11 yd	EA	\$41.46



### B



### B. Tubegauz®

Tubegauz seamless tubular gauze makes a neat conformable bandage for fingers, toes, hands, feet, elbows and knees.

SKU	Description	UOM	Price
5792-682000	Tubegauz 50 yd roll size 1 (finger/toe)	EA	\$14.96
5792-682010	Tubegauz 50 yd roll size 12 (finger/toe)	EA	\$37.35
5792-684392	Tubegauz white 50 yd roll size #2-7/8"	EA	\$13.82
5792-682020	Tubegauz white 50 yd roll size #34 1-1/2"	EA	\$18.98
5792-52910	Tubegauz applicator metal cage F (1.12"ID)F 01	EA	\$27.44
5792-682210	Tubegauz applicator size #2 for #12 cage	EA	\$34.16

### C. Tubegauz® Net

Tubegauz Elastic Net is a high-quality, seamless net made of nylon and rubber. It eliminates the use of adhesive tape and is ideal for patients who are allergic to tape, those who will have many dressing changes and where maximum aeration and freedom of motion are desired.

SKU	Description	UOM	Price
5792-680730	Tubegauz Elastic Net 25 yd white size 1	EA	\$16.08
5792-680740	Tubegauz Elastic Net 25 yd white size 2	EA	\$16.75
5792-680750	Tubegauz Elastic Net 25 yd white size 3	EA	\$19.52
5792-680760	Tubegauz Elastic Net 25 yd white size 4	EA	\$22.81
5792-680770	Tubegauz Elastic Net 25 yd white size 5	EA	\$27.28
5792-680780	Tubegauz Elastic Net 25 yd white size 6	EA	\$39.39
5792-680800	Tubegauz Elastic Net 25 yd white size 8	EA	\$75.61
5792-680820	Tubegauz Elastic Net 25 yd white size 10	EA	\$145.81
5792-680830	Tubegauz Elastic Net 25 yd white size 11	EA	\$158.77

### C





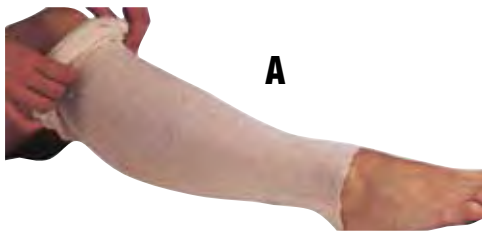

**A**

### A. Stockinette

Tubular cotton stockinette is made from high-grade yarn. It is inspected to ensure consistent knit construction, cleanliness and proper roll dimensions. It can be used under plaster casts for skin protection or to hold dressings in place while providing pressure.

SKU	Description	UOM	Price
0158IM220	Stockinette 2" x 25 yd	EA	\$10.42
0158IM320	Stockinette 3" x 25 yd	EA	\$14.33
0158IM420	Stockinette 4" x 25 yd	EA	\$18.40

### B. Shur-Band® LF

Shur-Band is a latex-free high-quality reinforced elastic support and compression bandage with a self-closure flap. It's easy-to-fasten the self-closure flap anywhere on the length of the bandage or either side. No clips, tape or pins are required to hold the bandages in place.

SKU	Description	UOM	Price
158759540000	Shur-Band latex free elastic bandage 4" 10/BX	BX	\$24.74

**B**



**C**

### C. REB® LF

Latex-free REB is a reinforced elastic bandage that offers balanced stretch and compression. This bandage is lightweight and ideal for general use. Perfect for securing splints, dressings, and ice packs and in the treatment of varicosities, sprains and strains. An all purpose bandage at an economical price.

SKU	Description	UOM	Price
15870620	Elastic bandage 2" x 5 yd 10/BX	BX	\$7.99
15870630	Elastic bandage 3" x 5 yd 10/BX	BX	\$9.56
15870640	Elastic bandage 4" x 5 yd 10/BX	BX	\$12.39
15870660	Elastic bandage 6" x 5 yd 10/BX	BX	\$18.22

### D. Elastic Bandage

Rubber elastic bandage. Secures with metal clip only. Washable and autoclavable. This product contains natural rubber latex which may cause allergic reactions.

SKU	Description	UOM	Price
DRU58	Elastic bandage 2"	EA	\$1.00
DRU60	Elastic bandage 3"	EA	\$1.28
DRU55	Elastic bandage 4"	EA	\$1.35

**D**



**A. Medi-Rip®**

Medi-Rip is a superior, self-adherent elastic support bandage. It is lightweight and comfortable to wear. Woven of 99% cotton yarn, Medi-Rip won't stick to skin or hair and leaves no adhesive residue. Medi-Rip tears easily to exact length so no cumbersome scissors are required. Medi-Rip is easy to control and apply.

SKU	Description	UOM	Price
15870510B	Medi-Rip tan 1" bulk 120/CS	CS	\$122.19
15870515B	Medi-Rip tan 1.5" bulk 250/CS	CS	\$364.56
15870520B	Medi-Rip tan 2" bulk 70/BX	BX	\$128.36
15870532B	Medi-Rip blue 2" x 5 yd bulk 70/BX	BX	\$130.09
15870530B	Medi-Rip tan 3" bulk 500/CS	CS	\$1249.09
15870533B	Medi-Rip blue 3" x 5 yd bulk 50/CS	CS	\$128.36
15870532	Medi-Rip blue 2" x 5 yd 12/BX	BX	\$24.70
15870533	Medi-Rip blue 3" x 5 yd 12/BX	BX	\$32.77
15870510	Medi-Rip tan self-adhering 1" x 5 yd 24/BX	BX	\$30.55
15870520	Medi-Rip tan self-adhering 2" x 5 yd 12/BX	BX	\$23.99
15870530	Medi-Rip tan self-adhering 3" x 5 yd 12/BX	BX	\$31.97
15870540	Medi-Rip tan self-adherent bandage, 4" x 5 yd 12/BX	BX	\$35.63
15870560	Medi-Rip tan self-adherent bandage, 6" x 5 yd 12/BX	BX	\$58.15



**B. Co-Lastic®**

Co-Lastic is a high-quality, cohesive elastic wrap, versatile enough to use as a securing, protective compression and support bandage. Designed with both you and your patients in mind it sticks securely to itself, but never to your patient's hair or skin. Co-Lastic provides even, controlled compression and readily conforms to every anatomical structure. It's water-resistant, lightweight and comfortable. Quick and easy-to-use; Co-Lastic is the right choice for you and your patients.

SKU	Description	UOM	Price
15874412	Co-Lastic cohesive wrap 1" x 5 yd 30/BX	BX	\$37.40
15874420	Co-Lastic cohesive wrap 2" x 5 yd 36/BX	BX	\$68.32
15874430	Co-Lastic cohesive wrap 3" x 5 yd 24/BX	BX	\$66.88
15874440	Co-Lastic cohesive wrap 4" x 5 yd 18/BX	BX	\$53.96
15874460	Co-Lastic cohesive wrap 6" x 5 yd 12/BX	BX	\$65.53



**C. Co-Wrap®**

Co-Wrap is a unique blend of cotton and polymer fibers that adhere securely to itself, not skin, hair or clothing. It's special construction also makes Co-Wrap porous so it's cool and comfortable to wear no matter how long it's worn. An easy-to-use, high-performance bandage, Co-Wrap is versatile and is effective even where sensitive tissue or wet environments are a consideration. Because it's cohesive, Co-Wrap is ideal as a secondary or securing bandage and for overwrapping primary dressings. Unlike bandages that require clips, tapes, or pins, Co-Wrap won't shift and slide.

SKU	Description	UOM	Price
15872910	Co-Wrap self-adherent bandage 1" x 5 yd 24/BX	BX	\$23.99
15872920	Co-Wrap self-adherent bandage 2" x 5 yd 12/BX	BX	\$17.03
15872930	Co-Wrap self-adherent bandage 3" x 5 yd 12/BX	BX	\$21.88



**D. 3M™ Coban™ Self-Adherent Wrap**

Coban is a conformable, lightweight, cohesive self-adherent elastic wrap. Coban self-adherent wrap may be used for compression dressings and for securing dressings and other devices. Coban self-adherent wrap is a laminate of non-woven material and elastic fibers placed lengthwise to provide elasticity. The elastic wrap contains a cohesive material that makes it stick to itself but not to other materials or skin.

SKU	Description	UOM	Price
43181581	Coban tape 1" x 5 yd 30/bx	BX	\$38.75
43181582	Coban tape 2" x 5 yd 36/bx	BX	\$85.00
43181583-24	Coban tape 3" x 5 yd 24/BX	BX	\$70.98
43181584-18	Coban tape 4" x 5 yd 18/BX	BX	\$66.71
43181586	Coban tape 6" x 5 yd 12/bx	BX	\$62.43





**A**

### A. CoFlex® NL

A softer, stronger cohesive bandage. CoFlex NL provides controlled compression with non-slip support to secure and protect primary dressings from dirt and moisture. CoFlex NL tears easily by hand and will not constrict. CoFlex NL is latex-free and provides 19 lbs. of tensile strength.

SKU	Description	UOM	Price
03905820	CoFlex NL cohesive bandage latex free 2" 36/CS	CS	\$67.22
03905830	CoFlex NL cohesive bandage latex free 3" 24/CS	CS	\$55.34
03905400	CoFlex NL cohesive bandage latex free 4" 18/CS	CS	\$69.13

### B. CoFlex® NL Kids Pack

A softer, stronger cohesive bandage. CoFlex NL "Kids Pack" provides controlled compression with non-slip support to secure and protect primary dressings from dirt and moisture. CoFlex NL tears easily by hand and will not constrict. CoFlex NL is latex-free and provides 19 lbs. of tensile strength.

SKU	Description	UOM	Price
03905200KP	CoFlex NL cohesive bandage latex free 2" kids pack, 36/BX	BX	\$90.81
03905300KP	CoFlex NL cohesive bandage latex free 3" kids pack, 24/BX	BX	\$74.99
03905400KP	CoFlex NL cohesive bandage latex free 4" kids pack, 18/BX	BX	\$69.13

**B**



**C**

### C. CoFlex®-Med

A softer, stronger cohesive bandage. CoFlex-Med provides 19 lbs. tensile strength (just under two times stronger than regular CoFlex) for maximum support and durability. CoFlex-Med provides controlled compression with non-slip support to secure and protect primary dressings from dirt and moisture. CoFlex-Med also tears easily by hand for quick and easy applications.

SKU	Description	UOM	Price
03903810	CoFlex-Med 1" 30/CS	CS	\$32.22
03903810BL	CoFlex-Med 1" blue 30/CS	CS	\$32.22
03903820	CoFlex-Med 2" 36/CS	CS	\$60.93
03903820BL	CoFlex-Med blue 2" 36/BX	BX	\$60.93
03903820BB	CoFlex-Med 2" blue 198/CS bulk	CS	\$243.67
03903820B	CoFlex-Med 2" tan 198/CS bulk	CS	\$243.67
03903830	CoFlex-Med 3" 24/CS	CS	\$53.90
03907300CP	CoFlex-Med 3" 24/CS Colorpk	CS	\$53.90
03903830BL	CoFlex-Med blue 3" 24/CS	CS	\$53.90
03903840	CoFlex-Med tan 4" 18/CS	CS	\$51.26

### D. Bantex

Bantex can be applied before handling rough or abrasive items. Bantex unrolls easily and helps prevent small finger injuries. It is non-sticky, but adheres to itself and stays sealed when wet. Bantex permits circulation and can be used to give added wrist support.

SKU	Description	UOM	Price
BAN1230G3/4	Bantex green 3/4" cut 16/PK	PK	\$24.28
BAN1230B1	Bantex blue 1" cut 12/PK	PK	\$22.41
BAN1230W1	Bantex white 1" 12/PK	PK	\$23.39
BAN1230W1.5	Bantex white 1.5" 8/PK	PK	\$23.39
BAN1230B2	Bantex blue 2" cut 6/PK	PK	\$24.28
BAN1230W2	Bantex white 2" 6/PK	PK	\$23.39

**D**





### A. 3M™ Microfoam™ Surgical Tapes

Microfoam Tape, an elastic foam, is tape designed to stretch and conform while providing secure adhesion to joints or skin folds. Microfoam tape is great for securing dressings and is water-resistant.

SKU	Description	UOM	Price
431815281	Microfoam tape 1" x 5-1/2 yd 12/BX	BX	\$33.27
431815282	Microfoam tape 2" x 5-1/2 yd 6/BX	BX	\$33.27

**A**



**B**

### B. 3M™ Micropore™ Surgical Tapes

The economical Micropore tape is a latex-free, hypoallergenic paper tape that has excellent adhesion yet is gentle to the skin. It is a general purpose, breathable surgical tape that is great for repeated applications on sensitive skin.

SKU	Description	UOM	Price
431815300	Micropore tape 1/2" x 10 yd 24/BX	BX	\$10.39
431815301	Micropore tape 1" x 10 yd 12/BX	BX	\$10.39
431815302	Micropore tape 2" x 10 yd 6/BX	BX	\$10.39

### C. 3M™ Durapore™ Surgical Tapes

The "silk-like" Durapore tape is the most economical, high-strength and high-adhesion tape that 3M has to offer. Great for securing dressings and tubing; it is conformable and has bi-directional tear.

SKU	Description	UOM	Price
431815381	Durapore tape 1" x 10 yd 12/BX	BX	\$16.27
431815382	Durapore tape 2" x 10 yd 6/BX	BX	\$16.27

**C**



**D**

### D. 3M™ Transpore™ Surgical Tape

3M™ Transpore Surgical Tape is a transparent plastic tape that is perforated with a polyethylene film. The tape has bi-directional tear, strong adhesion and is hypoallergenic. Transpore tape allows wound visualization and is easy to tear into thin strips, even with gloves on.

SKU	Description	UOM	Price
431815270	Transpore tape 1/2" x 10 yd 24/BX	BX	\$20.70
431815271	Transpore tape 1" x 10 yd 12/BX	BX	\$19.65
431815272	Transpore tape 2" x 10 yd 6/BX	BX	\$19.65

### E. Curasilk® Tape

Curasilk hypo allergenic cloth tape is made from rayon acetate and is ideal for general dressing use. Available in 10 yard rolls.

SKU	Description	UOM	Price
35837138	Curasilk 1" cloth tape 12/BX	BX	\$18.70
35837139	Curasilk 2" cloth tape 6/BX	BX	\$18.98
35837140	Curasilk 3" cloth tape 4/BX	BX	\$18.60

**E**



# First Aid/Medical

## Adhesive Bandages



**A**

### A. Porous Tape

CURITY™ Standard Porous Tape is an adhesive tape with linear porosity for maximum breathability. Designed to provide high tensile strength and aggressive adhesion. Pinked edges allow easy tearing. Provides general use economy.

SKU	Description	UOM	Price
35832304	Standard porous tape 1/2" x 10 yd 24/BX	BX	\$19.41
35832531	Standard porous tape 1" x 10 yd 12/BX	BX	\$21.65
35836613	Standard porous tape 2" x 10 yd 6/BX	BX	\$17.03

### B. Adhesive Tape

This adhesive tape works great for general first aid use. It can be used when dressing a wound or securing an I.V.

SKU	Description	UOM	Price
PAC8001	Adhesive tape 1/2" x 2-1/2 yd 2/BX	BX	\$.26
MF607-01	Adhesive tape, 1/2" x 5 yd w/proof roll	EA	\$1.34
MF621-01	Adhesive tape 1" x 5 yd	EA	\$2.17
3272045033	Adhesive tape waterproof 2" x 5 yd	EA	\$2.46

**B**



**C**

### C. Coverlet® Bandages

Coverlet bandages are comfortable and convenient. These bandages completely seal off the wound site and have a super absorbent pad. The fabric shapes provide maximum mobility with minimum discomfort.

SKU	Description	UOM	Price
07300230	Coverlets adhesive 3/4" x 3" 100/BX	BX	\$5.69
07300231	Coverlets adhesive 1" x 3" 100/BX	BX	\$6.48
073076448	Coverlets adhesive 1" x 3" 300/BX- 6 BX/CS	CS	\$109.54
07300330	Coverlets patch 1-1/2" x 2" 100/BX	BX	\$9.44
07300340	Coverlets bandage 2" x 3" 50/BX	BX	\$7.79
07300301	Coverlets spots 7/8" 100/BX	BX	\$5.72
07300303	Coverlets adhesive dressing 1-1/4", oval 100/BX	BX	\$6.58
07300385	Coverlets 4-wing bandages 50/BX	BX	\$15.81
07301306	Coverlets fingertip bandages small 100/BX	BX	\$10.37
07301307	Coverlets fingertip bandages large 50/BX	BX	\$9.89
07301390	Coverlets knuckle bandages 100/BX	BX	\$9.85

### D. FlexFab Bandages

These adhesive bandages are latex free and completely sterile for your safety. Made from FlexFab adhesive.

SKU	Description	UOM	Price
3271580033	Fabric bandages 3/4" x 3" 100/BX	BX	\$3.13
32711626000	Fabric bandages 3/4" x 3" 1300/CS	CS	\$39.04
32711595033	Fabric bandages 1" x 3" 100/BX	EA	\$3.61
32711631000	Fabric bandages 1" x 3" 1300/CS	CS	\$46.86
32711617033	Fabric patch bandages 2" x 3" 100/BX	EA	\$10.29
32711652000	Bandage 2" x 3" FlexFab patch 1500/CS	CS	\$142.13
32711570033	Bandage 2" X 4.5" XLG FlexFab 50/BX	BX	\$5.90
32711607033	Fabric bandages, fingertip - small 100/BX	BX	\$5.87
32711612033	Fabric bandages, fingertip - large 50/BX	BX	\$8.46
3271647025	Blue fabric fingertip bandages 1400/CS	CS	\$168.57
32711602033	Fabric knuckle-flex bandages 100/BX	BX	\$5.85
32711637000	Bandage knuckle fabric 1800/CS	CS	\$112.35
3271637025	Blue fabric knuckle bandages 1800/CS	CS	\$146.12
3271975033	Butterfly wound closures fabric medium 100/BX	BX	\$5.10
3271990033	Butterfly wound closures fabric large 100/BX	BX	\$6.52

**D**



## A. Plastic Bandages

Plastic adhesive bandages for quality wound protection. These bandages come in various shapes and sizes to fit your needs.

SKU	Description	UOM	Price
3271075033	Plastic adhesive bandage 3/4" x 3" 100's	BX	\$2.52
3271114000	Plastic adhesive bandage 1" x 3" 150's x 10	CS	\$34.60
3271090033	Plastic adhesive bandage 1" x 3" 100's	BX	\$2.85
3271114025	Plastic adhesive bandage 1" x 3" blue metal 1500S	CS	\$46.10
3271070033	Plastic adhesive bandage jumbo 2" x 4-1/2" 50's	BX	\$4.08
3271307033	Bandage spots 7/8" sheer 100/BX	BX	\$2.23



## B. CURITY® Adhesive Bandage

Made of perforated vinyl film, all bandages feature an "ouchless" TELFA® pad which promotes healing by not sticking to the wound. Hypo-allergenic adhesive reduces chance of irritation while being porous enough to allow skin to breathe.

SKU	Description	UOM	Price
35833065	Curity adhesive bandage - sheer transparent 3/4" 50/BX	BX	\$2.75
35833270	Curity adhesive bandage - sheer transparent 1" x 3" 40/BX	BX	\$5.90

## C. Sheer Adhesive Bandage

Keep wounds clean with these sheer adhesive bandages.

SKU	Description	UOM	Price
3271275033	Sheer adhesive bandages 3/4" x 3" 100/BX	BX	\$2.44
3271290033	Sheer adhesive bandages 1" x 3" 100/BX	BX	\$2.84



## D. 3M™ Steri-Strip™ Adhesive Skin Closures (Reinforced)

3M Steri-Strip Adhesive Skin Closures (reinforced) provide general wound support for increased tensile strength and finer wound edge approximation. They are made of a porous, non-woven backing coated with a pressure-sensitive, hypoallergenic adhesive and reinforced with polyester filaments for added strength.

SKU	Description	UOM	Price
4318R1541	Steri-Strips 1/4" x 3" 50/BX	BX	\$64.78
4318R1540	Steri-Strips 1/8" x 3" 50/BX	BX	\$64.78

## Shur-Strips®

Made of a non-woven nylon material which conforms to incision sites. Sterile.

SKU	Description	UOM	Price
DKC81118	Shur-Strips 1/4" x 3" 50/BX	BX	\$36.74
DKC81121	Shur-Strips 1/2" x 4" 50/BX	BX	\$61.29

## E. Benzoin Tincture

Benzoin contains 77% alcohol, which assures good adhesion for tapes after use, while protecting against skin breakdown.

SKU	Description	UOM	Price
0395-0243-92	Benzoin compound tincture 2 oz bottle	EA	\$11.51
DYNS42450	Benzoin, tincture swabsticks singles 50/BX	BX	\$17.34







**A**

### A. Jack Frost™ Instant Hot or Cold Packs

Jack Frost™ Instant Hot or Cold Packs are convenient for instant hot or cold therapy, just squeeze to activate. Available with insulation on one side of the pack to prevent loss of heat or cold.

SKU	Description	UOM	Price
34331407	Jack Frost Instant Cold Packs, insulated 5" x 5.5" 80/CS	CS	\$23.63
34331104	Jack Frost Instant Cold Packs, insulated 6" x 8.75" 24/CS	CS	\$12.69
343320204	Jack Frost Instant Cold Packs insulated & reusable 5.5" x 7" 24/CS	CS	\$27.42
34332104	Jack Frost Instant Cold Packs insulated & reusable 6" x 8.75" 24/CS	CS	\$27.42
34333104	Jack Frost Instant Hot Packs Insulated 6" x 8.75" 24/CS	CS	\$62.92

### B. Medi-First® Instant Cold or Hot Pack

Quickly activated by simply squeezing and shaking the pouch. Great for sprains and strains. Stays cold for 30 minutes.

SKU	Description	UOM	Price
MF724-01	Cold pack, 3-1/2" x 5", boxed, EA	EA	\$1.03
MF702-01	Instant cold pack 6" x 9", large	EA	\$1.33
MF713-01	Hot pack, large, boxed	EA	\$1.47



**B**



**C**

### C. Jack Frost™ Hot or Cold Gel Packs

Jack Frost™ Hot or Cold Gel Packs can be placed in the microwave for heat therapy or in the freezer for cold therapy. Remain flexible and are insulated and reusable.

SKU	Description	UOM	Price
34338600	Jack Frost Hot or Cold Gel Packs reusable 7.5" x 15"	EA	\$1.80
34337304	Jack Frost Hot or Cold Gel Packs reusable 4.5" x 10"	EA	\$1.78
343380104	Jack Frost Hot or Cold Gel Packs reusable 6" x 9"	EA	\$1.89
343380204	Jack Frost Hot or Cold Gel Packs reusable 4.5" x 7"	EA	\$1.80

### D. 3M™ Nexcare™ Reusable HotCold Pack

Nexcare Reusable ColdHot Pack is a soft, gel-filled pillow that provides hot or cold pain relief to any part of the body. Ideal for treating pain and swelling from bumps, bruises, muscle aches, strains and sprains.

SKU	Description	UOM	Price
43181570	Hot/Cold Packs Pro pack (4" x 10") 2/BX	BX	\$16.75
43181572	Cover for hot/cold packs 100/BX	BX	\$82.18



**D**

**A. Hydrocollator® E-1 Heating Unit**

Hydrocollator Heating Units remain the benchmark against which all others are judged. Durable and easy to maintain, these high-quality stainless-steel units have an almost indefinite life and ensure a constant supply of temperature consistent HotPacs.™ The E-1 is designed for small clinics where oversize HotPacs are needed.

SKU	Description	UOM	Price
1336-2102	Hydrocollator E-1 heating unit with 4 PKS	EA	\$585.16



**A**



**B**

**B. Hydrocollator® M-2 Heating Unit**

Durable and easy to maintain, these high-quality stainless-steel units have an almost indefinite life and ensure a constant supply of temperature consistent HotPacs.™ The M-2 has a extra-large insulated tank.

SKU	Description	UOM	Price
1336-2402	Hydrocollator heating unit M-2 with 12 PKS	EA	\$2150.28

**C. Hydrocollator® HotPac™ Steam Pack**

Hydrocollator Moist Heat HotPacs provide deep, soothing, moist heat for up to 30 minutes. One HotPac provides hundreds of treatments, making it cost effective. There are six HotPac sizes designed to fit every body contour.

SKU	Description	UOM	Price
1336-1012	Hydrocollator knee/shoulder pack	EA	\$38.49
1336-1002	Hydrocollator neck contour pack	EA	\$21.88
1336-1004	Hydrocollator pack oversize 15" x 24"	EA	\$43.02
1336-1014	Hydrocollator steam pack half size 5" x 12"	EA	\$14.42
1336-1006	Hydrocollator steam pack standard 10" x 12"	EA	\$18.82



**C**



**D**

**D. Hydrocollator® Terry Covers**

Hydrocollator Terry Covers are made from traditional terry knit weave and there is a cover to fit every size HotPac.™ They are washable, reusable and feature hook and loop closures.

SKU	Description	UOM	Price
1336-1104	Hydrocollator neck contour cover gray	EA	\$30.86
1336-1120	Hydrocollator foam-filled neck cover gray	EA	\$27.81
1336-1124	Hydrocollator cover oversize gray	EA	\$39.11
1336-1118	Hydrocollator foam-filled cover gray standard size	EA	\$39.70
1336-1102	Hydrocollator foam-filled cover standard gray	EA	\$29.32

**E. ColPaC®**

There is a ColPaC for every application. Multiple sizes of blue vinyl packs ensure effective cold therapy regardless of body shape.

SKU	Description	UOM	Price
1336-1508	ColPaC neck contour pack	EA	\$28.53
1336-1512	ColPaC oversize 11" x 21"	EA	\$40.81
1336-1502	ColPaC size 3" x 11"	EA	\$11.12
1336-1500	ColPaC standard size 11" x 14"	EA	\$22.49



**E**



**A**

### A. Treatment Table

This high-quality, economical table is constructed for years of service. Comfortable 2" high density foam top with Resist-All™ vinyl upholstery finish. With recessed H-Brace leg supports, high-pressure laminate legs it provides a sturdy surface for patients to sit. 72" long x 31" high x 24" wide. The weight capacity is 350 lbs. UL listed.

SKU	Description	UOM	Price
3052-4002	Treatment table with pad and H brace	EA	\$467.22

### B. Treatment Table with Shelf

The treatment table with pad and shelf combines comfort and practicality. Comfortable 2" high density foam top with Resist-All™ vinyl upholstery finish. With full length laminate covered shelf, laminate legs and H-braces, the table provides storage while ensuring stability. 72" long x 31" high x 24" wide. This table has a weight capacity of 350 lbs and is UL listed.

SKU	Description	UOM	Price
3052-4024	Treatment table with pad & shelf	EA	\$519.34



**B**

### C. Treatment Table with Cabinet

When maximizing space is a necessity, the treatment table with a cabinet underneath is a must. Features a comfortable 2" high density foam top. The storage cabinet is fully-enclosed, all-laminate with sliding doors and has an adjustable shelf. The table features a black laminate plywood base and is 72" long x 31" high x 27" wide. This table has a weight capacity of 350 lbs and is UL listed.

SKU	Description	UOM	Price
3052-4043-27	Treatment table with cabinet 27" wide	EA	\$1110.12



**C**

### D. Adjustable Exam Stool

Attractive styling and rugged good looks shine from this adjustable chrome stool. Features include a 14.5" diameter seat with 3" thick foam cushioning, chrome steel foot ring, and (4) 2" twin wheel black nylon casters.

SKU	Description	UOM	Price
3052-2116	Adjustable chrome exam stool with footring 18"-24"	EA	\$143.86



**D**



**E**

### E. Air-Lift Stool

Sit comfortably on the Air-Lift Stool, which features a single lever operated air-spring pneumatic height adjustment. With a height range of 7.5", anyone can find the most appropriate position. The seat is 14.5" in diameter and is made of 3" thick foam.

SKU	Description	UOM	Price
3052-2153	Air-Lift stool, 5 leg, blk, adj. ht. 19 1/2"- 27"	EA	\$173.68



**A. Exam Table Paper**

This exam table paper has a smooth, machine-glazed finish is gentle on the patient, yet durable to protect any type or size exam table from moisture, soil, or other damage.

SKU	Description	UOM	Price
6358913182LD	Exam table paper rolls 18" x 225 ft white smooth 12/CS	CS	\$43.09
6358914183	Exam table paper rolls 18" x 125 ft white crepe 12/CS	CS	\$56.34
6358913212LD	Exam table paper rolls 21" x 225 ft white smooth 12/CS	CS	\$48.14

**A**



**B**

**B. Drape Sheets**

Supply these tissue drape sheets as a lightweight, comfortable blanket for your patients. Perfect for short to moderate exams, the dependable wet-strength fabric conforms to the body and offers the ultimate in absorbency and softness.

SKU	Description	UOM	Price
6358918302	Drape sheets, 2-ply, white, 40" x 48" 100/CS	CS	\$24.91
6358918303	Drape sheets, 2-ply, white, 40" x 60" 100/CS	CS	\$32.56
6358918309	Drape sheets, 3-ply, white, 40" x 72" 50/CS	CS	\$48.89
63589380	Fabricell laminated stretcher sheets white 40" x 84" 50/CS	CS	\$60.75
6358919370	Poly-tissue transport sheets 40" x 90" blue 50/CS	CS	\$36.82

**C. Pillowcase**

A strong, comfortable and protective covering for pillows.

SKU	Description	UOM	Price
6358919355	Fabricell pillowcases 21" x 30" white 100/CS	CS	\$60.96
6358M29	Pillowcases 21" x 30" embossed poly white 100/CS	CS	\$41.31

**C**



**D**

**D. Pillow**

This standard size pillow provides a soft, comfortable place for patients to lay their heads.

SKU	Description	UOM	Price
CLAPP218	Pillow standard size 20" x 26" 18 oz	EA	\$9.35

**E. Exam Gown**

These exam gowns provide patients with comfort and modesty and offer knee-length coverage for convenient exam access. The multi-ply tissue construction is highly absorbent and economical.

SKU	Description	UOM	Price
6358918507	Exam gown open back, 3-ply, blue, 30" x 42" 50/CS	CS	\$33.49
6358910520	Exam gown w/open back, blue tissue 30" x 42" 50/CS	CS	\$45.13
6358910320	Front/back open, 3-ply, white, 30" x 42" 50/CS	CS	\$29.41

**E**





**A**

### A. Balance Beam Scale

Maximum strength, steel base and lever system, rotating easy-read poise bars with engraved, long lasting readings in pound/kilogram. Features a non-slip textured cover on 10-5/8" x 14" platform. The height rod is a Silent Slide® that measures 24"-84" x 1/8" and is reinforced to reduce breakage. Comes with a three year limited warranty.

SKU	Description	UOM	Price
1637402KL01	Balance beam scale 0-500 in kilograms & LB	EA	\$271.93
1637402	Balance beam scale 0-500 LB	EA	\$390.39

### B. Magnification Lamp

Provides undistorted magnification, a wide viewing area and a glare-free light. Features include a 3 diopter magnifying lens, a swivel neck and a spring balancing system enabling the lamp to be moved to any position. It has a 5" diameter, bi-convex lens and a 22W circline fluorescent tube.

SKU	Description	UOM	Price
0969-43144	Magnification lamp with base	EA	\$294.74
0969-43140	Magnification lamp without base	EA	\$178.95
0969-039	Replacement bulb	EA	\$23.33
096949	Stationary floorstand	EA	\$126.32
096950	Mobile floorstand	EA	\$129.82
096942	Clamp mount	EA	\$17.89
096943	Wall mount	EA	\$31.58

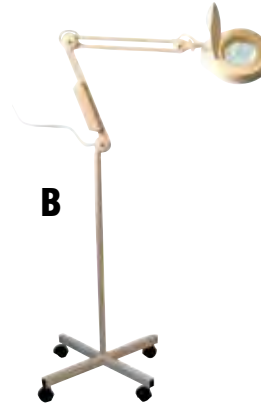

**B**

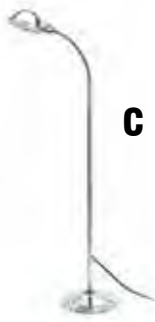

**C**

### C. Gooseneck Lamp

This conventional shade model is the ideal choice when you need a lot of light. With a weighted chrome base of 7.5 lbs and a 11" diameter, this sturdy lamp won't fall over. Total weight is 14 lbs. Exceeds all Tilt-Test requirements, UL. 75 watt bulb not included.

SKU	Description	UOM	Price
0072-426	Chrome gooseneck examination lamp with base	EA	\$94.21

### D. Blood Drawing Chair

Wide and comfortable, this chair helps patients relax and makes the task of drawing blood easier. Equipped with padded arm support that rotates 360°. With 13 inches of arm rest height adjustment, any size patient can be comfortable. Also features a convenient storage drawer and stain-resistant upholstery.

SKU	Description	UOM	Price
4443165	Blood drawing chair with storage drawer	EA	\$1054.98



**D**

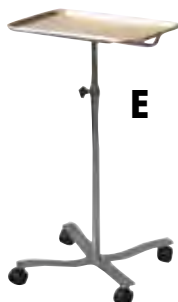

**E**

### E. Dual Position Instrument Stand

The Brandt Dual Position Instrument Stand combines stability with mobile convenience. The stand has 4 legs and may be used in either an offset or center post position. The height can be adjusted from 27-1/2" to 46-1/2" and the tray is 12-1/2" x 19".

SKU	Description	UOM	Price
096832000	Instrument stand dual position	EA	\$163.16

**A. IV Stand**

The double hook IV stand is chrome plated for a professional look. It has four casters for stability and securely holds two IV bags.

SKU	Description	UOM	Price
40322520	IV stand hi/lo double hook	EA	\$31.60

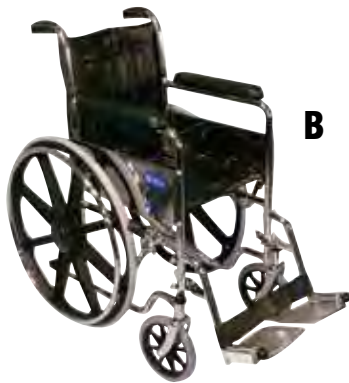
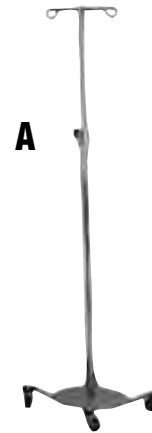

**B. Wheel Chair**

The Dalton e-Chair Fixed Arm offers high performance at a reduced price. The folding chrome plated frame with fixed full arms carries up to 250 lbs. The e-Chair features arm and calf pads, hard rubber tires, and aluminum foot plates.

SKU	Description	UOM	Price
TUF160	Wheelchair standard with footrest	EA	\$271.79
TUF160E	Wheelchair w/elevating legrest 18" with fixed armrest	EA	\$359.65
TUF375	Wheelchair w/elevating legrest 22" extra wide	EA	\$614.04

**C. Sundry Jars**

Made of opaque plastic, these sundry jars are great for organizing bandages, cotton balls and gauze.

SKU	Description	UOM	Price
286790-3455	Sundry jars opaque white plastic-labeled set of 5	BX	\$24.19



**D. Bath Basin**

The round wash basin, with a diameter of 13-1/8" and 6 qt. capacity, is great when you need to give a bath but can't be near a tub.

SKU	Description	UOM	Price
52164896	Basin bath 6 qt	EA	\$2.58

**E. Emesis Basin**

Plastic emesis basins by polar ware. Reusable/autoclavable.

SKU	Description	UOM	Price
5144PA-64	Emesis basin blue plastic 14 oz	EA	\$2.83
5144PA66	Emesis basin reusable heavy duty plastic 24 oz	EA	\$3.12





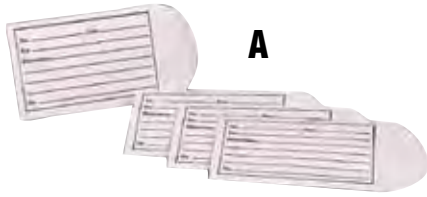

**A**

### E. Pill Envelope

These imprinted, white envelopes have ample room for instructions. They can be tailored for single dosages and are especially helpful if patient is taking more than one medication several times a day. It measures 3-1/2" x 2-1/2".

SKU	Description	UOM	Price
286783-9600	Pill envelopes sz 3 1/2" x 2 1/2" 1000/BX	BX	\$24.47

### B. Medicine Cups

Handy for distributing medications; these plastic 1 oz. cups are marked in cc's, ml's, ounces, grams, teaspoons and tablespoons.

SKU	Description	UOM	Price
0301B2719-5	Cup 1 oz medicine cup 100/PK	PK	\$1.43



**B**



**C**

### C. Flat-Bottomed Cups

Disposable cups with a flat bottom.

SKU	Description	UOM	Price
SOLO44	Cup 3 oz water flat bottom paper 100/PK	PK	\$9.22
SOLO450	Cup 3.5 oz white pleated paper 5000/CS	CS	\$244.14
DRU44	Cup 5 oz drinking translucent 100/SL	SL	\$2.99

### D. Tongue Depressors

Sized at the standard 6" x 11/16", these tongue depressors are for applications in oral patient examination.

SKU	Description	UOM	Price
3022704	Tongue depressors - standard 500/BX	BX	\$9.68
3022711	Tongue depressors - juniors 500/BX	BX	\$7.55
3022709	Tongue depressors - individually wrapped RG 250/BX	BX	\$8.18
302225-705	Tongue depressors - sterile 100/BX	BX	\$3.58



**D**



**E**

### E. Silver Nitrate

Grafco® Silver Nitrate Applicators are 6", wooden and tipped with 75% silver nitrate; 25% potassium nitrate. Silver nitrate tips (70 mg) are soluble in all secretions. Control strength by dipping in water. They come in a convenient dispenser tube vial. This product requires a prescription.

SKU	Description	UOM	Price
286747-1590	Silver Nitrate 6" Applicators 100/PK	PK	\$62.95

### F. Safety Pins

Great for securing bandages, these safety pins are nickel-plated.

SKU	Description	UOM	Price
28678330392C	Safety pins #2 nickel plated 144/BX	BX	\$1.86
28678330393C	Safety pins #3 nickel plated 144/BX	BX	\$2.01

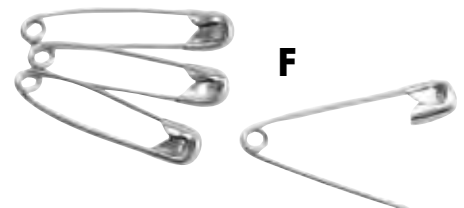

**F**

### A. Playtex Tampons

Playtex Tampons feature a rounded tip for comfortable insertion and the original plastic applicator.

SKU	Description	UOM	Price
ROCPLAYTEX	Playtex tampons vendor pack 500/CS	CS	\$142.34



**A**



**B**

### B. Sanitary Napkins

Twin Grooves system® designed for leak protection and a cotton-like cover for dryness. Each maxi is individually wrapped in a sanitary plastic wrapper for cleanliness.

SKU	Description	UOM	Price
ROC25027000	Sanitary napkins #4 200/CS	CS	\$62.12

### C. Tampax Tampons

Tampax Tampons provide trusted protection during your period. They feature an open-end, flushable and biodegradable applicator.

SKU	Description	UOM	Price
HOSTAMPAX	Tampax tampons vendor pack 500/CS	CS	\$111.00



**C**



### WEB INFORMATION

For a full listing and online ordering visit our website at: [www.gosafe.com](http://www.gosafe.com)

# First Aid/Medical

## Reference Books



**A**

### A. Physician Desk Reference

The Physician Desk Reference provides Food and Drug Administration approved labeling for drugs as well as prescription information provided by manufacturers for grand-fathered drugs and other drugs marketed without FDA approval. Some dietary supplements and other products are also included.

SKU	Description	UOM	Price
1563637499	Book Physician Desk Reference	EA	\$127.56

**B**



### B. Non-Prescription Physician Desk Reference

Physicians' Desk Reference for Non-prescription Drugs and Dietary Supplements features product information for Non-prescription drugs and dietary supplements. Also includes five color-coded indices and a full-color product information guide.

SKU	Description	UOM	Price
1563637502	Book PDR Non-Prescription	EA	\$78.88

**C**

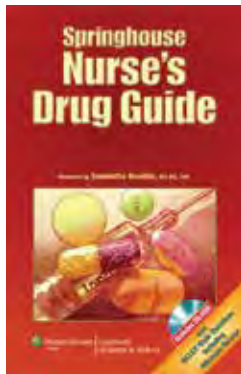

### C. Springhouse Nurse's Drug Guide

The Springhouse Nurse's Drug Guide offers more than 750 common generic drugs, as well as discussing safe and accurate drug therapy as it relates to the nursing process. It features alphabetical organization of drug monographs, pronunciation guide for every drug, I.V. administration section for every I.V. drug, and many useful appendices.

SKU	Description	UOM	Price
1582558086	Book Springhouse Nursing Drug	EA	\$56.23

**D**



### D. Taber's Medical Dictionary

Taber's Medical Dictionary 20th Indexed Edition is for students and practitioners. This dictionary includes color illustrations and a new appendix of complementary and alternative medicine. Includes 56,000 terms.

SKU	Description	UOM	Price
0803683103	Book Taber's Medical Dictionary 20th ED. Indexed	EA	\$57.23

**E**



### E. Merck Manual

The 18th edition the Merck Manual is a reference for physicians, residents and nurses. It contains diagnosis and treatment of common clinical disorders, arranged by organ system, etiology or specialty.

SKU	Description	UOM	Price
091190166	Book Merck Manual 18th Edition	EA	\$101.27



**A**



### A. Calapro® Finger Cots

These Calapro Finger Cots are latex and rolled, making them easy to put on. A mechanical tumbling process has removed excessive powder.

SKU	Description	UOM	Price
CALAFLO1S	Finger cots USDA blue 5 MIL 144/BX small	BX	\$2.28
CALAFLO1M	Finger cots USDA blue 5 MIL 144/BX medium	BX	\$2.28
CALAFLO1L	Finger cots USDA blue 5 MIL 144/BX large	BX	\$2.28
CALAFLO1XL	Finger cots USDA blue 5 MIL 144/BX xlarge	BX	\$2.28

**B**



### B. Latex Finger Cots

Latex finger cots can be used alone or over whole-hand gloves on individual fingers for added protection. They are more comfortable and less expensive than double gloving and also available in opaque. 144/Box.

SKU	Description	UOM	Price
286788-3910S	Finger cots latex rolled small 144/BX	BX	\$2.96
286788-3910M	Finger cots latex rolled medium 144/BX	BX	\$2.96
286788-3910L	Finger cots latex rolled large 144/BX	BX	\$2.96
286788-3910X	Finger cots latex rolled xlarge 144/BX	BX	\$3.09

**C**



### C. Faceshield

Infectious disease control shield (Spit Shield). This is a complete face shield assembly with elastic attachment and foam forehead cushion. 5 shields in a resealable bag.

SKU	Description	UOM	Price
PAUIDC/F	Faceshield full face head shield 5/pk	PK	\$18.98

**D**



### D. Micro-Touch® Surgical Gloves

Micro-Touch Latex Surgical Gloves are single use, sterile gloves. Made from white natural rubber latex and has an anti-slip bisque finish to improve grip. Gloves are powdered with absorbable dusting powder, U.S.P. Gloves are of high quality and can be used with confidence.

SKU	Description	UOM	Price
50255855	Micro-Touch Surgical Gloves size 5.5 40 PR/BX	BX	\$31.01
50255860	Micro-Touch Surgical Gloves size 6.0 40 PR/BX	BX	\$31.01
50255865	Micro-Touch Surgical Gloves size 6.5 40 PR/BX	BX	\$31.01
50255870	Micro-Touch Surgical Gloves size 7.0 40 PR/BX	BX	\$31.01
50255875	Micro-Touch Surgical Gloves size 7.5 40 PR/BX	BX	\$34.12
50255880	Micro-Touch Surgical Gloves size 8.0 40 PR/BX	BX	\$31.01
50255885	Micro-Touch Surgical Gloves size 8.5 40 PR/BX	BX	\$34.12



**A**

### A. MediGuard® Powdered Latex Gloves

MediGuard® powdered latex gloves offer excellent sensitivity, making them ideal for almost any application. Powdered with medical grade absorbable dusting powder (USP) for donning ease, they're non-textured with beaded cuffs for added durability. Meets all ASTM and FDA requirements. A great overall value.

SKU	Description	UOM	Price
50253111	MediGuard latex gloves - Small 100/BX	BX	\$8.86
50253112	MediGuard latex gloves - Med 100/BX	BX	\$8.86
50253113	MediGuard latex gloves - Large 100/BX	BX	\$8.86

### B. MediGuard® Powder-Free Latex Gloves

MediGuard® PF latex gloves have high elasticity and provide excellent tactile sensitivity. They are ideal for use in procedures that require greater dexterity and they are textured to help ensure a secure grip.

SKU	Description	UOM	Price
50253191	MediGuard latex powder-free gloves - Small 100/BX	BX	\$9.43
50253192	MediGuard latex powder-free gloves - Med 100/BX	BX	\$9.43
50253193	MediGuard latex powder-free gloves - Large 100/BX	BX	\$9.43



**B**



**C**

### C. MediGuard® Select Synthetic Exam Gloves

A cost-effective alternative that's perfect for general patient care. New technology has improved the tactile sensitivity and durability of these quality latex-free gloves.

SKU	Description	UOM	Price
50253101	MediGuard select synthetic gloves - small 100/BX	BX	\$4.45
50253102	MediGuard select synthetic gloves - med 100/BX	BX	\$5.69
50253103	MediGuard select synthetic gloves - large 100/BX	BX	\$5.69
50253104	MediGuard select synthetic gloves - x-large 100/BX	BX	\$4.45

### D. Diamond Grip™ Gloves

These gloves provide an exceptional balance of performance, comfort and durability. Manufactured by a controlled process for greater product consistency. Gloves are fingertip textured for enhanced wet and dry gripping. This powder free glove is longer and thicker than most standard exam gloves on the market today for added protection. Gloves are made from premium low-modulus natural rubber latex for a true fit and reduced hand fatigue. Caution (LATEX): This product contains natural rubber latex (latex) which may cause allergic reactions. Safe use of this glove by or on latex sensitized individuals has not been established.

SKU	Description	UOM	Price
MFD300XS	Diamond Grip Gloves powder-free latex 100/BX- x-small	BX	\$14.15
MFD300S	Diamond Grip Gloves powder-free latex 100/BX- small	BX	\$14.15
MFD300M	Diamond Grip Gloves powder-free latex 100/BX- medium	BX	\$13.90
MFD300L	Diamond Grip Gloves powder-free latex 100/BX- large	BX	\$14.15
MFD300XL	Diamond Grip Gloves powder-free latex 100/BX- x-large	BX	\$13.90



**D**

©2011 MICROFLEX CORPORATION. ALL RIGHTS RESERVED.

### A. MicroTouch Nitrile

MicroTouch powder free exam gloves are made of 100% nitrile. Gloves are blue and powder free to prevent possible contamination of wounds and tests. MicroTouch gloves have a higher resistance to chemicals than most latex or vinyl gloves.

SKU	Description	UOM	Price
50253441	MicroTouch nitrile - powder free gloves 50/BX small	BX	\$9.52
50253442	MicroTouch nitrile - powder free gloves 50/BX medium	BX	\$9.52
50253443	MicroTouch nitrile - powder free gloves 50/BX large	BX	\$9.52
50253444	MicroTouch nitrile - powder free gloves 50/BX x-large	BX	\$9.52

A



B

### B. Powder-Free SafetyPlus™ Latex Gloves

SafetyPlus gloves provide the user with added protection. These powder-free gloves are thicker and longer than standard latex exam gloves and provide an ambidextrous fit. Gloves are 15 mils thick at finger tips and 12" in length.

SKU	Description	UOM	Price
5594BS0410-1	P2® latex exam gloves, safety plus - powder-free, small	BX	\$31.04
5594BS0420-1	P2® latex exam gloves, safety plus - powder-free, medium	BX	\$31.04
5594BS0430-1	P2® latex exam gloves, safety plus - powder-free, large	BX	\$20.82
5594BS0440-1	P2® latex exam gloves, safety plus - powder-free, x-large	BX	\$20.82

### C. Sensicare® Non-Sterile Gloves

The Sensicare Non-Sterile Gloves are smooth, latex-free and feature a beaded cuff. These gloves are thicker and more durable than standard nitrile gloves. They are available in powdered or powder-free form.

SKU	Description	UOM	Price
0723484311	Sensicare powder-free gloves 100/BX small	BX	\$6.75
0723484312	Sensicare powder-free gloves 100/BX medium	BX	\$6.75
0723484313	Sensicare powder-free gloves 100/BX large	BX	\$6.75
0723484314	Sensicare powder-free gloves 100/BX x-large	BX	\$6.75

C



D

### D. UltraSense™ EC

Finally, a soft nitrile EXTENDED CUFF glove with a latex fit! UltraSense™ EC is an extended cuff, nitrile glove with the comfort, fit, and feel of latex. UltraSense™ EC offers amazing comfort combined with extra protection over the wrist and forearm for use in high-risk environments. UltraSense™ EC forms to your hand like latex, without the associated risks, and provides reliable barrier protection against many hazardous and infectious substances.

SKU	Description	UOM	Price
MFDUSE-800SM	UltraSense™ EC, 100/BX, small	BX	\$15.96
MFDUSE-800MD	UltraSense™ EC, 100/BX, medium	BX	\$15.96
MFDUSE-800LG	UltraSense™ EC, 100/BX, large	BX	\$15.96
MFDUSE-800XL	UltraSense™ EC, 100/BX, x-large	BX	\$15.69
MFDUSE-800XX	UltraSense™ EC, 100/BX, xx-large	BX	\$15.96





**A**

### A. Latex Disposable Gloves

These 5 mil latex disposable gloves are available in exam or industrial grade. Rolled cuff, 9" long.

SKU	Description	Size	UOM	Price
MSG4010S	Latex disposable gloves, powder free, exam grade	S	100/BX	\$7.01
MSG4010M	Latex disposable gloves, powder free, exam grade	M	100/BX	\$7.01
MSG4010L	Latex disposable gloves, powder free, exam grade	L	100/BX	\$7.01
MSG4010XL	Latex disposable gloves, powder free, exam grade	XL	100/BX	\$7.01
MSG4015S	Latex disposable gloves, powder free, industrial grade	S	100/BX	\$6.05
MSG4015M	Latex disposable gloves, powder free, industrial grade	M	100/BX	\$6.05
MSG4015L	Latex disposable gloves, powder free, industrial grade	L	100/BX	\$6.53
MSG4015XL	Latex disposable gloves, powder free, industrial grade	XL	100/BX	\$6.05

### B. SYN-COR Vinyl Disposable Gloves

These 5 mil vinyl disposable gloves are available in "SYN-COR Silver," a lightly-powdered industrial grade and "SYN-COR Gold," a powder-free exam grade glove. USDA/FDA accepted materials for use in food processing.

SKU	Description	Style	Size	UOM	Price
MSG4060S	Syn-Cor vinyl gloves, exam grade	Powder free	S	100/BX	\$4.45
MSG4060M	Syn-Cor vinyl gloves, exam grade	Powder free	M	100/BX	\$4.45
MSG4060L	Syn-Cor vinyl gloves, exam grade	Powder free	L	100/BX	\$4.45
MSG4060XL	Syn-Cor vinyl gloves, exam grade	Powder free	XL	100/BX	\$4.45
MSG4075S	Syn-Cor vinyl gloves, industrial grade	Lightly powdered	S	100/BX	\$3.66
MSG4075M	Syn-Cor vinyl gloves, industrial grade	Lightly powdered	M	100/BX	\$3.66
MSG4075L	Syn-Cor vinyl gloves, industrial grade	Lightly powdered	L	100/BX	\$3.66
MSG4075XL	Syn-Cor vinyl gloves, industrial grade	Lightly powdered	XL	100/BX	\$3.66



**B**



**C**

### C. NeoPro Powder-Free Gloves

NeoPro is made of synthetic polymers. This glove combines the barrier performance of a synthetic with the comfort typically found in natural latex. The NeoPro is powder-free, has tactile sensitivity and is textured for a secure grip.

SKU	Description	Size	UOM	Price
MFNP144S	NeoPro gloves	S	100/BX	\$14.40
MFNP144M	NeoPro gloves	M	100/BX	\$14.40
MFNP144L	NeoPro gloves	L	100/BX	\$14.40
MFNP144XL	NeoPro gloves	XL	100/BX	\$14.40



### A. Ultimate N-DEX® Long Cuff Gloves

N-DEX 100% nitrile medical grade long-cuffed exam glove. This glove is non-latex and features Best's proprietary beaded and rolled cuff design. These gloves come in powder-free and low powder styles.

SKU	Description	UOM	Price
BST9905PFS	N-DEX gloves powder-free 6 mil 11" 50/BX class I small	BX	\$14.82
BST9905PFM	N-DEX gloves powder-free 6 mil 11" 50/BX class I medium	BX	\$14.82
BST9905PFL	N-DEX gloves powder-free 6 mil 11" 50/BX class I large	BX	\$14.82



### B. TNT® Blue Thin Nitrile Gloves

Disposable nitrile gloves set a whole new standard in durability and chemical splash protection. Feature textured finger tips for exceptional grip. Recommended for manufacturing, light-duty maintenance, automotive, intricate parts handling, laboratory analysis and technical work. Lightly powdered in a clean polybag. Superior flexibility, puncture resistance, made of 100% nitrile. The glove contains absolutely no fillers, additives, silicones, or plasticizers. Rolled cuff gives additional cuff strength and protects the skin from chemicals running off the glove. Comply with FDA regulations for food contact.

SKU	Description	Thickness	Size	UOM	Price
ANS92575M	TNT nitrile gloves	4 mil	M	100/BX	\$9.60
ANS92575L	TNT nitrile gloves	4 mil	L	100/BX	\$9.60
ANS92575XL	TNT nitrile gloves	4 mil	XL	100/BX	\$9.81

### C. Touch N Tuff®

Touch N Tuff disposable gloves set a whole new standard in comfort, durability, dexterity, and cleanliness. Made of 100% nitrile, the gloves contain absolutely no fillers, silicones, or plasticizers. And, although they are only 4 mils thick, Touch N Tuff gloves provide three times the puncture resistance of competitive latex or vinyl gloves. 9.5 inches in length, they are available powdered or powder-free.

SKU	Description	Size	UOM	Price
ANS92500S	Touch-N-Tuff, powdered	S	100/BX	\$10.48
ANS92500M	Touch-N-Tuff, powdered	M	100/BX	\$10.48
ANS92500L	Touch-N-Tuff, powdered	L	100/BX	\$10.48
ANS92500XL	Touch-N-Tuff, powdered	XL	100/BX	\$10.48
ANS92600S	Touch-N-Tuff, powder free	S	100/BX	\$12.72
ANS92600M	Touch-N-Tuff, powder free	M	100/BX	\$12.72
ANS92600L	Touch-N-Tuff, powder free	L	100/BX	\$12.72
ANS92600XL	Touch-N-Tuff, powder free	XL	100/BX	\$12.72



### D. Nitrilite®

Nitrilite gloves solve many of the contamination problems caused by vinyl and natural rubber latex gloves in today's clean rooms. Designed specifically for critical environments, nitrilite gloves offer significantly reduced particulate and extractable levels. They are 100% powder-free and contain no plasticizers, silicone, or pigments. Plus, the superior strength of nitrile means nitrilite gloves can be thinner than comparable vinyl or latex gloves, which results in a lighter, more comfortable glove with improved dexterity and tactility. Length 12", thickness 4 mil.

SKU	Description	Size	UOM	Price
ANS93-311-LG	Nitrilite gloves	L	100/BX	\$17.74
ANS93-311XL	Nitrilite gloves	XL	100/BX	\$17.74

# Prescription Drug Authorization Form

Please contact customer service for a complete selection of prescription items.

Company: \_\_\_\_\_ Date: \_\_\_\_\_

Person Authorized to Administer: \_\_\_\_\_

Company Address: \_\_\_\_\_

Fill out this portion of the form only if you are assuming full responsibility for the specific drug or drugs which you have listed below:

I, \_\_\_\_\_, MD will assume full responsibility for the Legend Prescription  
(Signature)  
drugs listed below being sent to this company to be used under my directions for the employees of this company:

_____	_____
_____	_____
_____	_____

----- - OR - -----  
Fill out this portion of the form only if you are assuming full responsibility for all Legend Prescription drugs that are sent to this company.

I, \_\_\_\_\_, MD will assume full responsibility for the Legend Prescription  
(Signature)  
drugs that are sent to this company to be used under my directions for the employees of this company.

If this company is allowed to administer Scheduled Drugs under your direction, please complete the following statement.

Control Drug Authorization: I certify that I have a current DEA License for the company listed above and the scheduled drug class allowed on this license is 5\_\_\_\_ 4\_\_\_\_ 3N\_\_\_\_ 2\_\_\_\_ 2N\_\_\_\_.

Note: For this company to administer Scheduled Drugs you must furnish us a copy of your DEA License showing the same address as the "Ship To" address for the company.

\_\_\_\_\_  
Physician's Name

\_\_\_\_\_  
DEA Number

\_\_\_\_\_  
Address

\_\_\_\_\_  
DEA Expiration Date

\_\_\_\_\_  
City, State, Zip

\_\_\_\_\_  
State License Number



Return to:  
P.O. Box 1929  
Marshall, TX 75671

\_\_\_\_\_  
Physician's Signature





W. Joe Shaw, Ltd. d.b.a. Medsafe Credit Application- \_\_\_\_\_

PO Box 1929, Marshall, TX 75671 ph # 800-442-8839 fax # 903-935-2060

Please complete, sign and return via fax or e-mail.

e-mail to: lois\_reed@gosafe.com or barbara\_beach@gosafe.com

Company Name: \_\_\_\_\_

Bill to: \_\_\_\_\_ Ship To: \_\_\_\_\_

City, State, Zip: \_\_\_\_\_ City, State, Zip: \_\_\_\_\_

County/Parish: \_\_\_\_\_ County/Parish: \_\_\_\_\_

Telephone #: \_\_\_\_\_ Fax #: \_\_\_\_\_

Business is a (circle one): Corporation Sole Proprietor Partnership

Duns #: \_\_\_\_\_ Date Started: \_\_\_\_\_ State: \_\_\_\_\_

Estimated Monthly Sales: \_\_\_\_\_ Credit Line Requested: \_\_\_\_\_

Is your business tax exempt: Yes \_\_\_\_\_ No \_\_\_\_\_

\*\*\*If yes is checked, a tax exempt/ resale certificate must accompany this application\*\*\*

Owners, Principals, and/or Officers Names and Titles

\_\_\_\_\_  
\_\_\_\_\_  
\_\_\_\_\_

A/Payable Name: \_\_\_\_\_ Phone #: \_\_\_\_\_

A/P E-Mail address: \_\_\_\_\_

Purchasing Contact: \_\_\_\_\_ Email: \_\_\_\_\_

Credit References (Business Names; City, State; Fax # & Telephone #)

1. \_\_\_\_\_
2. \_\_\_\_\_
3. \_\_\_\_\_
4. \_\_\_\_\_

Please answer the following questions:

1. Do you require a purchase order? \_\_\_\_\_

2. Please authorize designated people to place verbal orders. \_\_\_\_\_

3. Are there any outstanding judgments against the company? \_\_\_\_\_

4. Has this company declared bankruptcy within the past seven years? \_\_\_\_\_

5. Is this company a party to a lawsuit? \_\_\_\_\_

Credit Terms are net 30 days from the date of the invoice. Outstanding balances are subject to 1.5% per month interest after 30 days from the date of invoice. The undersigned authorizes and releases all persons and companies listed on this application to furnish information to Medsafe and for Medsafe to obtain credit reports.

\_\_\_\_\_  
Authorized Signature

\_\_\_\_\_  
Date

This page may be torn out and faxed or mailed to Medsafe.

## Index

## A

Acoustic Calibrators	218
Adjustable Beam Anchors	84–86
AED Cases	310
Aerosol Can Disposal	290
Air Blower Canister Fans	295
Air Blower Saddle Vent	295
Aircraft Wand	303
Air Horn	364
Airway Kit	482
Alcohol	521
Alcohol Testing	512–513
Allergist Tray	472
Aluminized Clothing	168
Anchorage	
Concrete	88
Connectors	85–92
Fixed	87
Anemometers	216–217
Aneroid Sphygmomanometers	500
Ankle Support	285
Antibacterial Hand Sanitizer	523
Anti-Fungal	447
Antiseptic Cleansing	519–524
Antiseptic Spray	441, 442
Aprons	
Cut Resistant	144
Denim	145
Hycar	145
Neoprene	144
Polyethylene	144
PVC	145
Tyvek®	143
Vinyl	145
Arc Protection	
Balaclava	167
Kits	166–167
Arm Sling	477–478

## B

Bacitracin Antibiotic Ointment	445
Backboard Accessories	489
Backboards	487
Back Support	279
Back-Up Alarm	366
Bandages Adhesive	534–535
Bandages Cohesive	530–532
Bandages Conforming	526
Bandages Elastic	530

Bandanas	332
Barrier Safety	
Man-Way Cross™ Barrier	414
Bath Basin	541
Batteries Alkaline	304
Benzoin Tincture	535
Biohazard	
Bags	515
Kits	516
Waste Can	515
Bite-Blocks	482
Blankets	475
Blood Clotting Spray	442
Blood Collection	472
Blood Pressure Monitors	501
Body Bag	475
Books, Medical Reference	544
Boot Covers	
Tyvek®	148
Boots	
Dielectric	258
Hazmat	261
Neoprene	259
PVC	259–260
Rubber	258
Yellow Latex	261
Bouffant Cap	147
Burn Blanket	440
Burn Dressings	439
Burn Jel	439
Burn Kits	438
Burn Sheets	475
Burn Spray	441, 442
Burn Wrap	440
Butterfly IV Needles	469
	<b>C</b>
Cabinets Safety	289
Cable Protectors	365
Camera CCTV	366
Carabiners	67
Chainsaw Chaps, <i>See</i> Chaps	
Chair, Blood Drawing	540
Chaps	148
Chapstick®	461
Chinstraps, <i>See</i> Hard Hats	
Cigarette Disposal	299
Cleaners	517–518
Cold Packs	536, 537
Cold Spray	442
Compliance Centers	400–402
Confined Space and Rescue	93–94, 110
Containment Berms	292–293
Cooling Vest	334
Hi-Vis	334
Cot, Fold Out	490
Cotton Balls	528
Cotton Rolls	528
Cotton Tip Applicator	528
Coveralls	
Flame-Resistant	
2112 Blend	328
Cotton	328
Cotton, Insulated	315
TECGEN Select®	328
Coveralls, Disposable	
ChemMax®	141–142
MicroMax®	140
Pyrolon® FR	141
Tyvek®	143
Coveralls, FR	
Cotton Insulated	156
Indura®	155
Nomex®	156
Pyrolon®	168
TECGEN®	156
TrueComfort®	155
UltraSoft®	155
CPR Barriers	480–481
CPR Training Manikin	483
Crutches	477
Cup Dispenser	335
Cups	335
	<b>D</b>
Debris Netting	109
Defibrillators	478–479
Delineator	361
Dewatering Bag	293
Diabetes Testing Supplies	510–511
Disposable Manual Resuscitator	485
Dosimeters	219–220
Drain Seals	293
Dressings Medical	525–529
Drill Points	496
Drug Testing	513–514
Drum Dolly	291
Drum Funnels	291
Drum Overpack	291
Drum Pallets	291–292
Duffel Bags	167
Dust Monitoring	217
Dynamometer	509
	<b>E</b>
Ear Care	462

Earmuffs	247–249	Floor Mats	305	Goggles	187–189
AM/FM MP3	249	Floor Tapes	419–420	Cutting	272
Earplugs	243–246	Fluorescein Sodium Strips	498	Goggle Clip	191
Banded	244, 246	Foot Guards	264	Goggle Cover	191
Dispenser	244	Forceps	494	Goggle Retainer	191
Reusable	243, 246	Forklift Safety	306–307	IR Cutting	273
Elbow Support	283–284				
Electrical	305	<b>G</b>		<b>H</b>	
Electrolyte Drinks	336–338	Gas Cans	290	Hairnets	147
Electrolyte Tablet	454	Gas Detection		Hard Hat Liner	331
Embroidery	10	Badge	213	Hard Hats	
Emesis Basin	541	Calibration	210, 211, 214	Cap Style	196, 198, 200, 201
EMT Bag	474	Calibration Gas	214	Chinstraps	200
Endotracheal Tubes	482	Single Gas	209	Full Brim	197, 198, 199
Entry Permits	414	Stand-Alone System	213	Harley-Davidson®	200
Exam Gown	539	Gas Detection Tubes & Pump	215	Patriotic	199
Exam Table	538	Gauze Pads	526	Suspensions	200
Exam Table Paper	539	Gauze Sponges	526	Vented Cap Style	196, 199
Extrication Collars	486	GFCI Outlet	305	Hard Hat Storage	206
Eye Charts	499	Gloves		Harnesses	45–63
Eye Cups	466	Canvas	133	Accessories	65–68
Eye Drops	464–465	Cut-Resistant	112–119	Care and Inspection	64
Eye/Face Wash	297	Dyneema	114, 116	Head Immobilizers	487
Eye Irrigation Solution	466, 467	Hi-Vis	113	Headlamps	301
Eye Magnet	496	Kevlar	114, 116	Headset, Communication	226
Eye Pads	527	Taeki 5	115	Heater, Tent	326
Eye & Skin Flush Station	466	Drivers	126–128	Heating Unit (Medical)	537
Eye Spears	498	Hi-Viz	128	Heat Shield	440
		Lined	127, 323–324	Heat Stress Label	338
<b>F</b>		Glove Bag	137	Heat Stress WBGT	217
Faceshields	545	Glove Clips	137	Hoods	
Cap Mounted	274–275	Impact	117	Tyvek®	143
Frames	202–206, 274	Impact-Reducing	322, 333	Horizontal Lifelines	
Head Gear	274–275	Lined	322	Components	40–44
Visors	202–206	Jersey	133	Concrete Systems	36–37
Visors Cutting	274	Leather Palm	129	Road and Bridge Systems	32–33
Fall Protection		Lined	325	Specialty Systems	38–39
Concepts	28–29	Palm Coated	122–125	Structural Steel Systems	34
Standards	95	Latex	122	Technology	30–31
Testing	27	Nitrile	123, 125	Temporary	110
Training	27, 98–99	Polyurethane	124	Hot Packs	536, 537
Fencing	109	Hi-Vis	124	Humidity/Temp Datalogger	216
Fiberglass Fabric	273	Performance	325	Hydration Pack	334
Finger Cots	545	Lined	325	Hydrocortisone	445
Fire Extinguisher Cover	298	String Knit	134	Hydrogen Peroxide	441
Fire Extinguisher Pull Pins	298	Supported	135		
Fire Extinguisher Pull Pin Seals	298	Nitrile	135	<b>I</b>	
Fire Extinguishers	298	PVC	135	Ice Chest	335
Fire Extinguisher Tag	298	Thermal Liner	325	Identification Badges	431
First Aid Cream	445	Unsupported	135	ID Holders	192
First Aid Kits	436–437	Nitrile	135	Incision and Drainage Set	476
Flashlights	301–303	Welders	276–277	Insect Protection	340–341
Floatation Vest	151	Welding	131–132	Insoles	254
		Gloves Exam	545–549	Stainless Steel	263



# Index

Instrument Stand (Medical)	540	Logger's Kit	206	Parkas, FR	
Instrument Trays	497			Indura®	163
Itch Relief	441–443	<b>M</b>		Nomex®	163
IV Catheter	469	Magnifying Binocular	497	Penlights	498
IV Solutions	468	Map Holders	383	Percussion Hammer	496
IV Stand	541	Medicine Cups	542	Perimeter Safety	308
IV Start Kit	468	Metatarsal Guards	264	Peroxide	521
		Mirrors	305	Petroleum Jelly	446
<b>J</b>		Morgan® Lens	467	Pill Envelope	542
Jackets		Morph! X, 1 Item	213	Pillowcase	539
Flame-Resistant		Multi-Trauma Dressing	476	Pillows	539
8812 Blend	313–315, 317	Muscle Pain Relief	448–450	Pinwheel	496
Cotton	313–314, 317			Pipe Markers	404–407
Hi-Viz	358	<b>N</b>		Plastic Chain	361
Jackets, FR		Nasal Cannula	484	Polyethylene Drum Liner	295
Cotton	164	Nasal Sprays	463	Polyethylene Sheeting	295
Indura®	163	Neck Shades	330	Posters	
		Netting	109	Motivational	427
<b>K</b>		Noise Dosimeters	250	Training	396
Kneepads	286–287	Noise Indicator	250	Povidone Iodine	520
Knee Support	285			Product Customization	7
		<b>O</b>		Psychrometer	216
<b>L</b>		Ophthalmoscopes	505		
Lab Coats		Oral Medications		<b>R</b>	
Tyvek®	143	Cold & Allergy Relief	453–454, 456, 458	Rags	300
Lab Coats, FR		Cough Lozenges	454, 456, 458	Rainwear	
Cotton	165	Cough Suppressant Syrup	458	Chemical	150
Nomex®	165	Muscle Pain Relief	451	Raincoats	149–150
Labels		Pain Relief	451, 455, 457	Rainsuits	149–150
Chemical Identifier (Roll)	395	Sinus Relief	453, 456	Rainwear, FR	169
Hazardous Materials	393	Stomach Care	452, 456, 459–460	Rebar Caps	362
Hazardous Waste	398–399	Throat Lozenges	458	Rebar Chain Assembly	69
Right-To-Know PPE	395	Otoscopes	504–506	Reflective Highway Triangle Kit	360
Shipping Labels	397	Overalls		Relief Safety Devices	65
Laceration Tray	476	Flame-Resistant		Rental Program	6
Lamps		Quilt Lined	315	Repair Center Information	6
Gooseneck	540	Overalls, FR		Rescue Equipment	110
Magnification	540	Cotton Quilt Lined	162	Respirator Bag	241
Lanyards		Cotton Unlined	162	Respirator Cleaning	240
Positioning	69	Overshoes	262–263	Respirator Cooling	236
Shock Absorbing	70–78	Oximeter	508–509	Respirator Fit Test	241
Leather Work Boots	252–255	Oxygen Cylinder	484, 485	Respirators	
Lens Cleaning	193–194	Oxygen Cylinder Cart	485	Cartridges	232, 234
Light Meter	217	Oxygen Cylinder Wrench	484	Disposable	228–231
Lockout AC Plug	349, 411	Oxygen Mask	484	Welding	271
Lockout Adjustable Cable	348	Oxygen Resuscitator	485	Escape	239
Lockout Circuit Breaker	349, 408			Full Face Mask	232–233
Lockout Electrical Switch	349, 408	<b>P</b>		Half Face Mask	232–234
Lockout Group Box	348, 410	Padlocks	344	PAPR	235–238
Lockout Hasp	345, 348, 349	Pad Printing	20	Welding	268–270
Lockout Kits	345, 346, 412	Pants, FR		Welding	230
Lockout Stations	347, 412–413	88/12 Canvas	161–162	Respirator Spray Socks	240
Lockout Tags, <i>See</i> Tags		Denim	160–161	Retractable Cone Bar	339, 360
Lockout Valves	350, 409	TECGEN®	160		

Ring Buoy	151	Headers Only	374	Stretchers	488, 490
Ring Cutter	495	Housekeeping & Environmental	374	Strobe Light	366
<b>S</b>					
Safety Glasses	173–186	Lockout	374	Studs	
Dust & Particulate	185–186	MARSEC	385	Ice	263
Eyewear Retainers	192	Muster Point	384	Studs, Ice	326
IR Cutting	273	NFPA Placard	395, 397	Suction Units	482
OTG	179, 183	NFPA Placard Sign Kits	396	Sundry Jars	541
Polarized	173, 176, 182	Paddle Slow/Stop	363	Sunscreens	339
Safety Pins	542	Personal Protective Equipment	374–375, 424	Sun Shades	330
Safety Railing System	96	Projection	382	Surgical Cauterise	497
Safety Showers	297	Radiation, Laser & Radio	375	Suture Removal Kit	495
Safety Sign Information	368	Roll-Up	363	Swabs	
Scales	540	Safety Scoreboards	424–426	ChromateCheck™	275
Scalpels, Disposable	497	Safety/Slips, Trips & Falls	375	LeadCheck™	275
SCBA	239	Smoking Control	376	Sweatbands	332
Scissors	493–494	Store-Boards™	433	Sweatshirts	
Screen Printing	22	Traffic	415–423	Flame-Resistant	315
Self Retracting Lifelines (SRL)	79–82	Traffic - Industrial	376	Sweatshirts, FR	164–165
Sharps Container	473	Sign Stand		Syringes	470–471
Sheets Drape	539	Spring Loaded	363	<b>T</b>	
Shin Guards	264	Tripod	363	Tags	
Shirts		Silver Nitrate	542	Barricade	309, 362
Flame Resistant		Site-Boards™	432	Blank Header	389
8812 Blend	329	Skin Cleaner	300	By-The Roll	392
Cotton	329	Skin Cream	299	Cylinder & Service Status	390
Shirts, FR		Skin Lotions	524	Fire Extinguisher Records	390
88/12 Twill	159	Sleeves		Hanger Tags	391
TECGEN®	158	Flame Resistant	146	Inspection	309, 390
TrueComfot®	157	Heat Resistant	147	Lockout	345, 390, 411
UltraSoft®	157	Kevlar®	146	Loop 'n Strap™	391
Shoe Covers		Protective	146	Metal	403
Polypropylene	148	Terry	146	Perma-Tags™	391
Sign Material	379	Tyvek®	147	Production Control	389
Sign Posts	415	Snake Guards	149	Scaffold	309, 390
Signs		Snaphooks	68–69	Standard Safety	389
Admittance & Exit	369–370	Soap Dispensers	300	Tag Materials	392
ANSI-ISO	376	Socks	256	Tampons	543
Banners	428	Solar Arrow Boards	339	Tape	
Bilingual	377	Sorbent Pads	294	Barricade	362
Chemicals & Hazardous Materials	370–371	Sound Level Meters	218–220	Barrier	362
Confined Space	372	Specimen Containers	514	Duct	304
Construction	372	Spill Kit	294	Electrical	305
Custom	378–381	Spirometer	508	Tape First Aid	534
Electrical	372–373	Splinter Removal	494–495	Tape Surgical	533
Equipment & Operations	373	Splints	491–492	Tents	339
Evacuation & Shelter	384	Sports Drinks, <i>See</i> Electrolyte Drinks		Testing Supplies, Medical	511–512
Eyewash/Shower	386	Steering Wheel Cover	413	Therabath®	509
Fire Safety & Emergency	373	Stethoscopes	502–503	Theraputty™	509
First Aid & AED	374	Stockinette	530	Thermometers	
Fold-Up	421	Stools	538	Environment	217
		Storage Cases	310	Medical	507
		Stretcher Accessories	488	Toe Guards	264

# Index

Tongue Depressors	542	Wheel Chair	541
Tool Bags	105, 107–108	Wheel Chuck	365
Tool Lanyards	102–104, 106–107	Whistle	364
T.E.S.T.S. Product Data	100	Windsock	364
Toothache Relief	461	Windsock Frame	364
Traffic Cones	360	Winter Liners	319–321
Collapsible Traffic Cone	360	Wipes	300
Traffic Stanchion	361	Wrist Support	280–283
Traffic Stanchion Sign Holder	361		
Traffic Vest			
Class 2	353–356, 359		
FR Protection	355–356		
Class 3	356–357		
Non-Rated	357		
Traffic Vest, FR	171		
Trailer Safety	308		
Trauma Kits	474		
Triangular Bandage	476		
Triple Antibiotic Ointment	444		
Tubegauz®	529		
Tweezers	494		
Two-Way Radios	222–225		
Two-Way Radio Battery	225		
Two-Way Radio Charger	222, 225		
Two-Way Radio Mic	225		

## U

Umbrella	339
Utility Knife	304
Utility Trays	292

## V

Vaseline® Gauze	525
Vertical Systems	83–84

## W

Waders	261
Wader Suspenders	261
Wall Cases	310
AED	479
Respirator	310
Wallet Cards	396
Warming Packs	321
Waste Cans	290
Biohazard	515
Water Coolers	335
Water Cooler Sealing Tape	335
Weather Station	216
Welders Full Face Shroud	270
Welding Clip-on Shield	271
Welding Curtains	273
Welding Electronic Shield	271
Welding Fume Extractors	275
Welding Hood	266–267

## Z

Zinc Oxide Ointment	446
---------------------	-----





Safety Begins With Us

Search Enter Keywords

GO

Order Status View Cart Help My Account

Click Here for Site Usage Instructions

Home Products Advance Search Brands Services Catalog Contact Us

## GoSafe.com - Designed for the End-User

At Medsafe, our goal is to make life easier and more efficient for you, the end-user. Whether you are working from your office, the jobsite, or even at home, **GoSafe.com** provides 24/7 convenience - right at your fingertips.

**GoSafe.com** contains thousands of product listings in a wide variety of categories, and employs a searchable database that allows you to locate the products you need quickly and easily.

**GoSafe.com** was designed for the you - the End User. As such, the site is not just a collection of products. **GoSafe.com** provides key features that make doing business with Medsafe practical, efficient, and economical.

Below is a partial list of services provided by **GoSafe.com** :

- XML Integration
- Automatic Email Invoice Billing
- Electronic Data Interchange (EDI)
- Custom built Hot Lists for online ordering
- Quick add to cart
- Review Online Invoices, Order Status & History
- Email Shipment Notifications
- Multiple User Administration Tool
- File Upload Capabilities



### XML Integration

Sends Purchase Orders electronically via the internet or email.



### Punchout Catalog

Real-Time access to pricing and availability. Approved Shopping Carts are processed through gosafe.com without manual order entry.



### Hot List

List of approved or reoccurring purchased items for quick ordering.



### Electronic Data Interchange (EDI)

Automatic import & export of datausing ANSI X12 standard of EDI.



Phone: (800) 330-9240 • Fax: (281) 476-5394 • E-mail: sales@gosafe.com





## Corporate Office - La Porte, TX

4200 Underwood, La Porte, TX 77571  
(P.O. Box 1025)  
Deer Park, TX 77536  
Customer Support: 1-800-330-9240  
Fax: 1-281-476-5394  
Order Inquiries: sales@gosafe.com

## Marshall, TX Office

4101 W. Pinecrest Dr. (P.O. Box 1929)  
Marshall, TX 75670 (75671)  
Customer Support: 1-800-442-8839  
Fax: 1-903-935-2117  
Order Inquiries: sales@gosafe.com

### Oklahoma Office

4432 S. 70th East Ave.  
Tulsa, OK 74145  
Customer Support:  
1-888-622-8758  
Fax: 1-918-622-8341  
Order Inquiries:  
sales@gosafe.com

### Arkansas Office

6500 Young Rd, Suite C  
Little Rock, AR 72209  
Customer Support:  
1-800-394-9026  
Fax: 1-501-227-6455  
Order Inquiries:  
sales@gosafe.com

### Louisiana Office

39359 Airline Plaza  
Gonzales, LA 70737  
Customer Support:  
1-877-854-2178  
Fax: 1-225-647-4520  
Order Inquiries:  
sales@gosafe.com

### Service Center

4200 Underwood  
(P.O. Box 1025)  
Deer Park, TX 77536  
Customer Support: 1-800-330-9240  
Fax: 1-281-476-5394  
Rental/Service Inquires:  
service@gosafe.com

## 2112 Flash Fire & 70E Arc Flash Protection Clothing Available Exclusively from MEDSAFE



From the refinery to the oilfield, the 2112 line of Flash Fire & Arc Flash Protective Clothing offers complete protection wherever a flash fire hazard exists, or HRC2 level protection from flash fire is required.

The 2112 line includes a full range of clothing, including coveralls, shirts, and outerwear, and is available in 6 & 7 oz. weights (depending upon the item).

The 2112 line of Flash Fire & Arc Flash Protective Clothing is available in Navy Blue, Khaki, Grey, and Royal Blue. Each of these colors is common in industries where FR garments are widely used.



Order Online at [www.gosafe.com](http://www.gosafe.com)  
Call Us at 800.330.9240



GoSafe.com